

ZA ZE ZI ZO ZU

- COME COMINCIA IL NOME DI CIASCUNA FIGURA? PRONUNCIALO E POI COLLEGALO ALLA SILLABA CORRETTA.

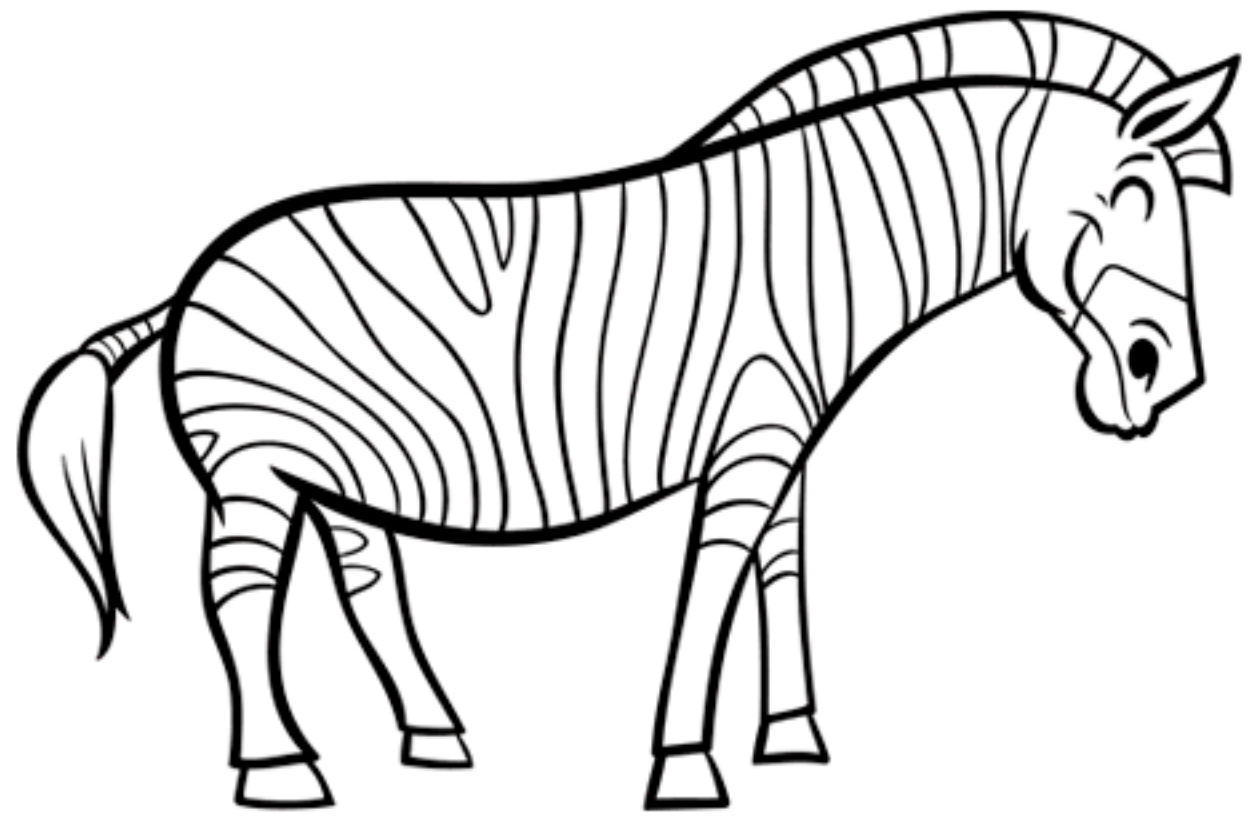

ZA



ZE



ZI



ZO

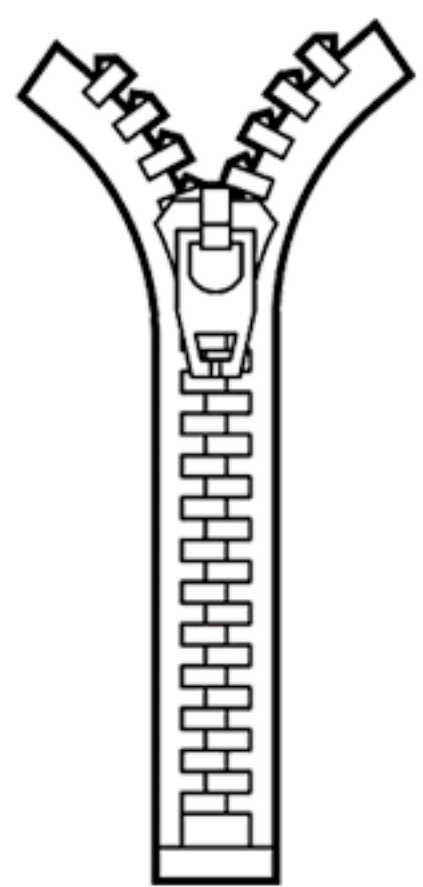

ZU

- SCAMBIA LA POSIZIONE DI CONSONANTI E VOCALI, POI LEGGI LE SILLABE.

ZA

ZE

ZI

ZO

ZU

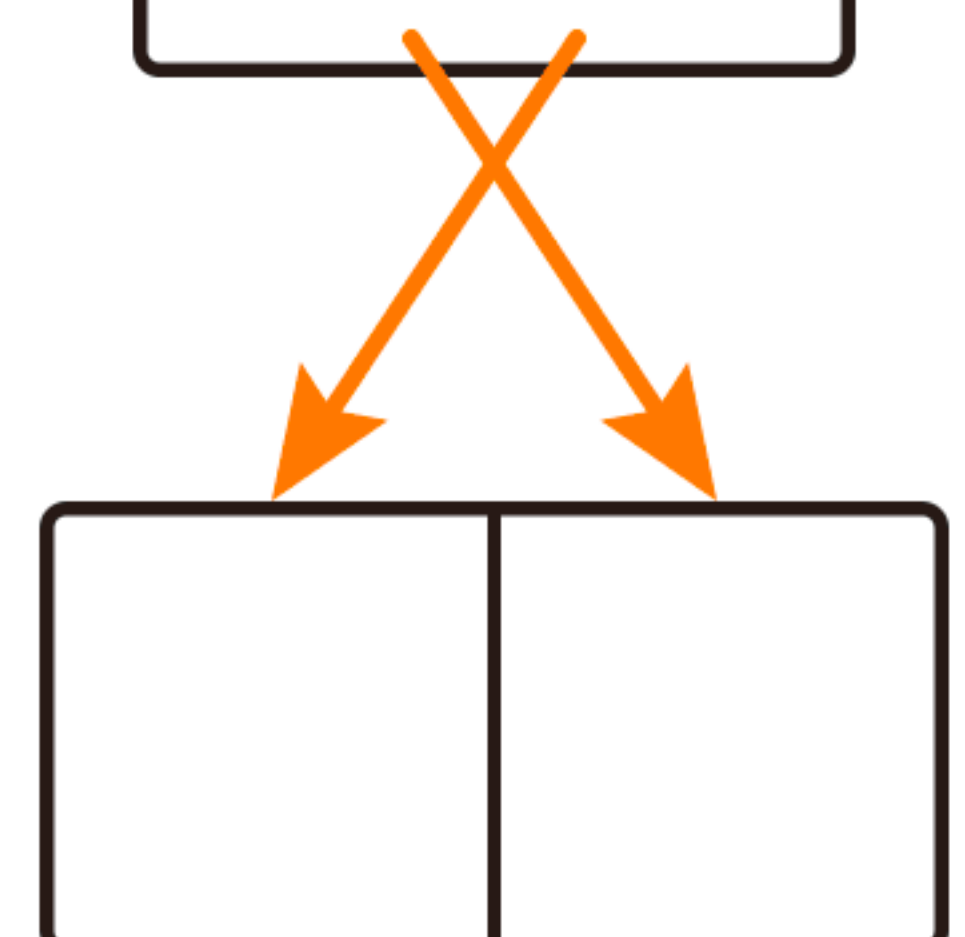
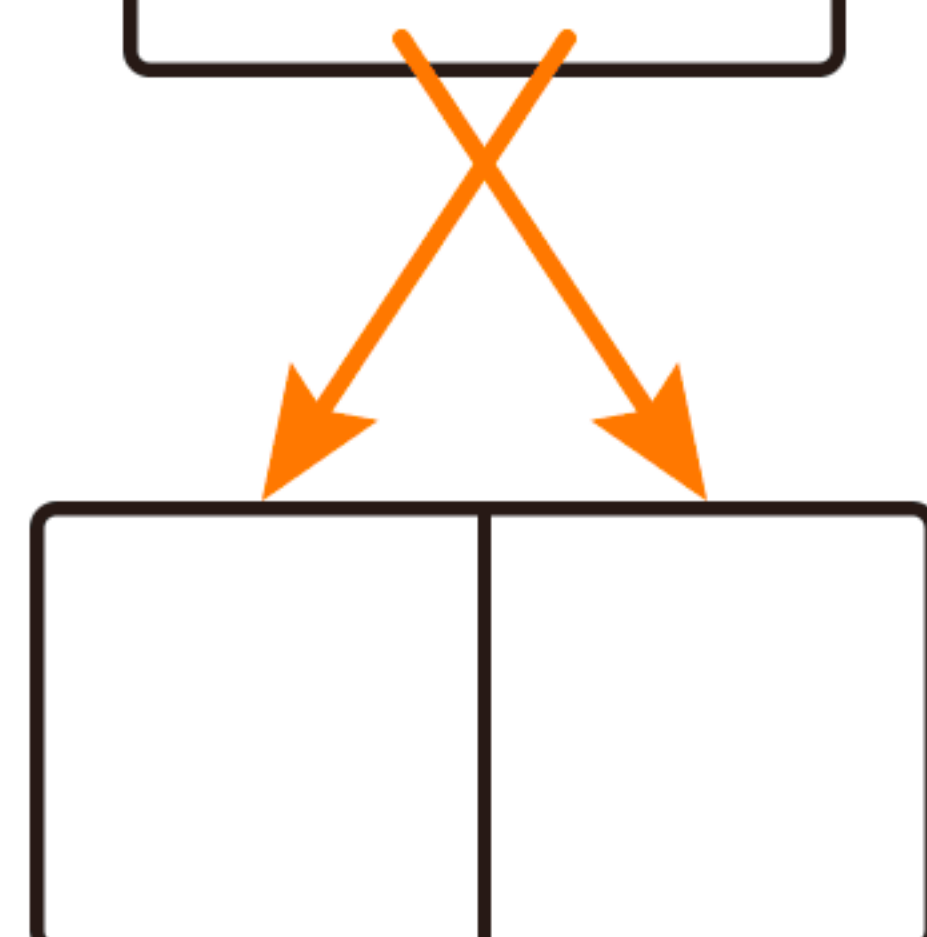
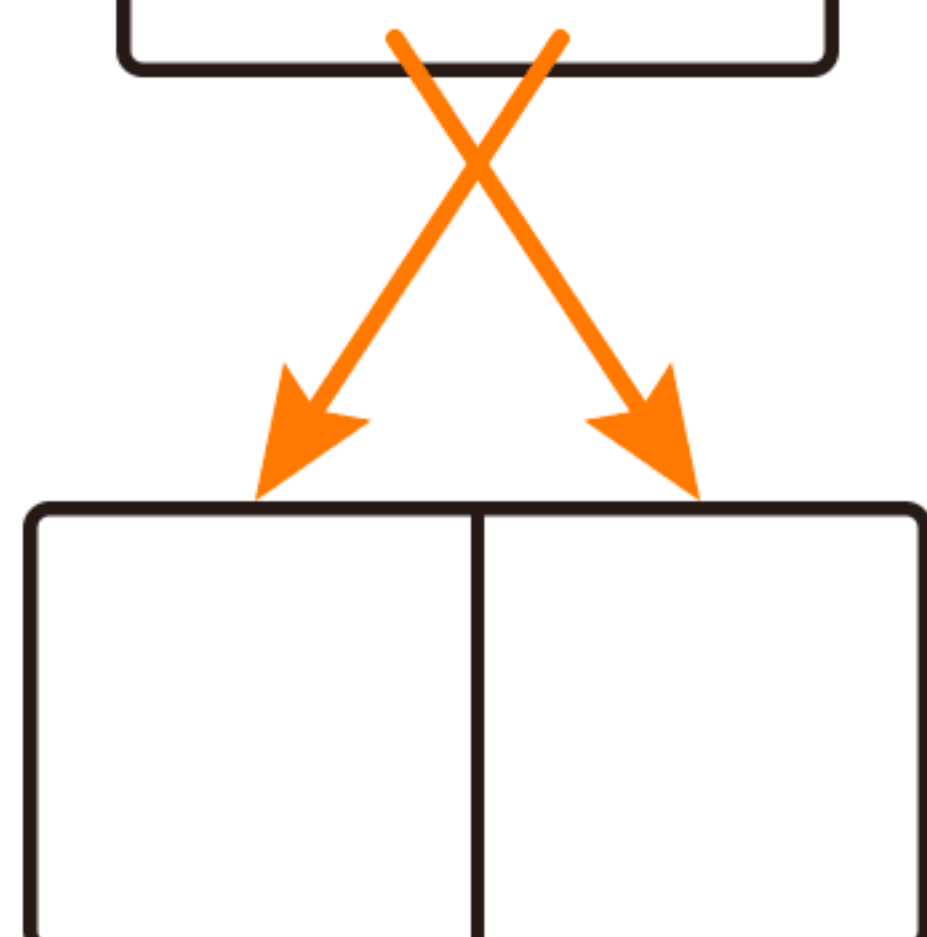
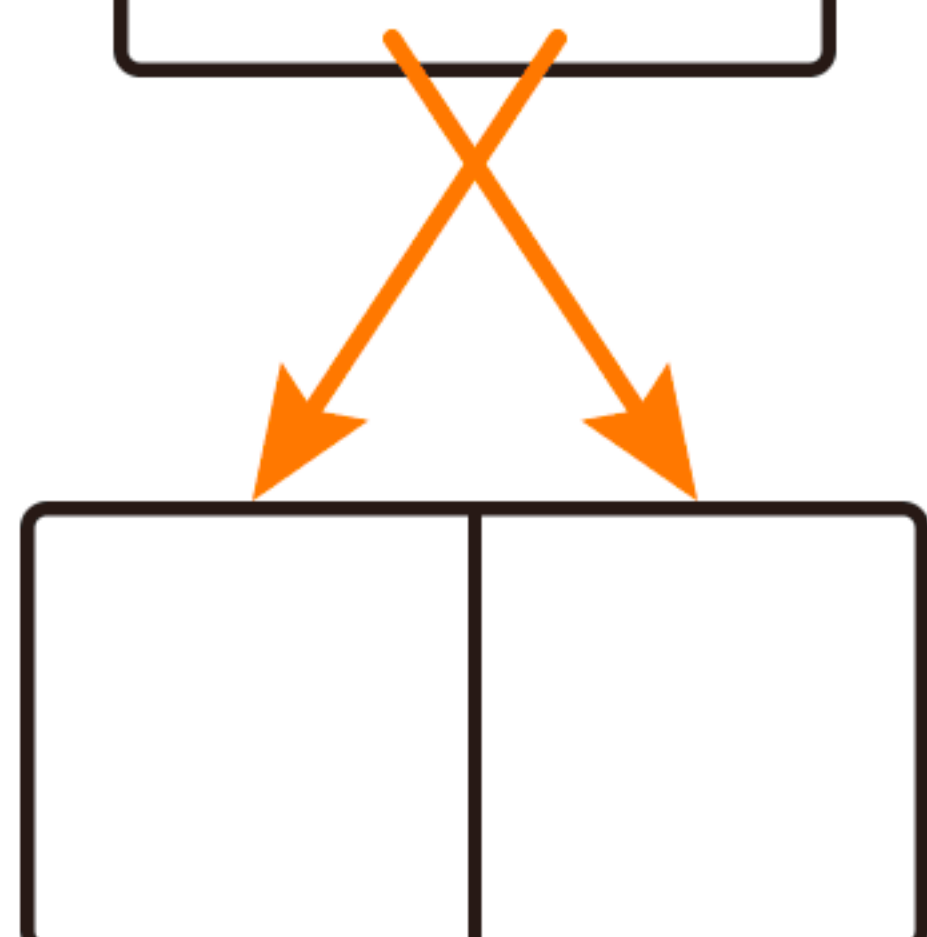
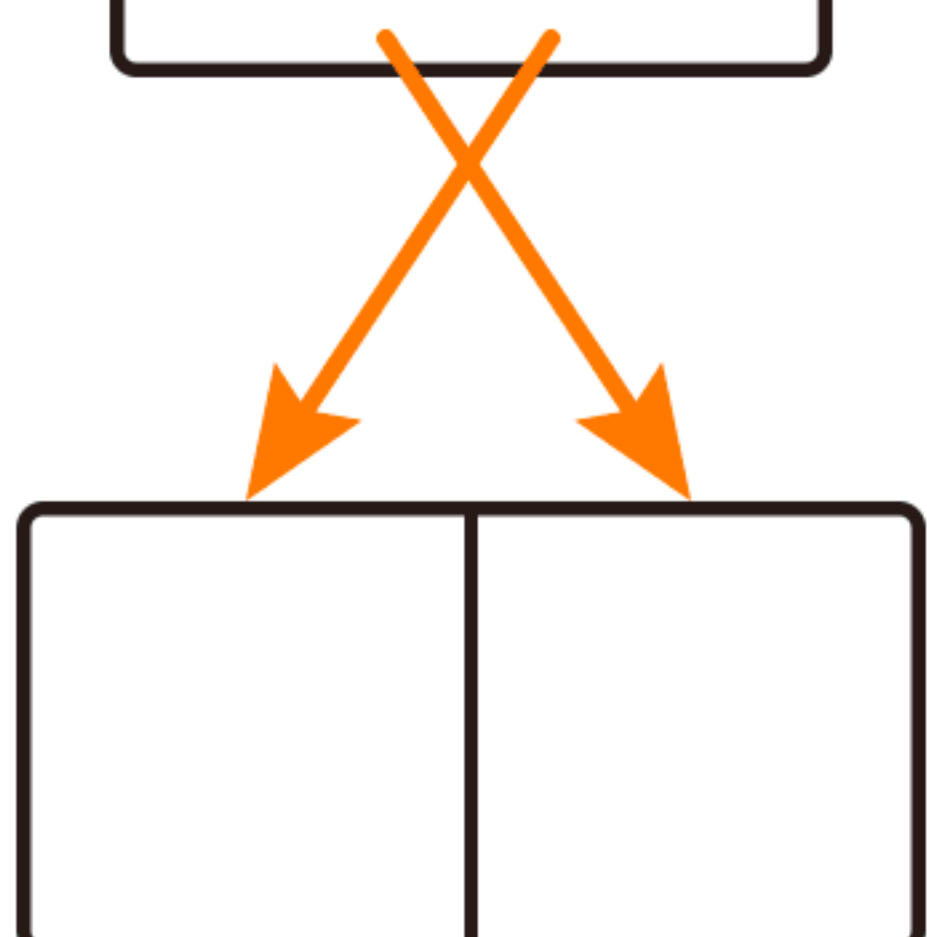

ZA ZE ZI ZO ZU

- COMPLETA LE PAROLE CON ZA, ZE, ZI, ZO, ZU.

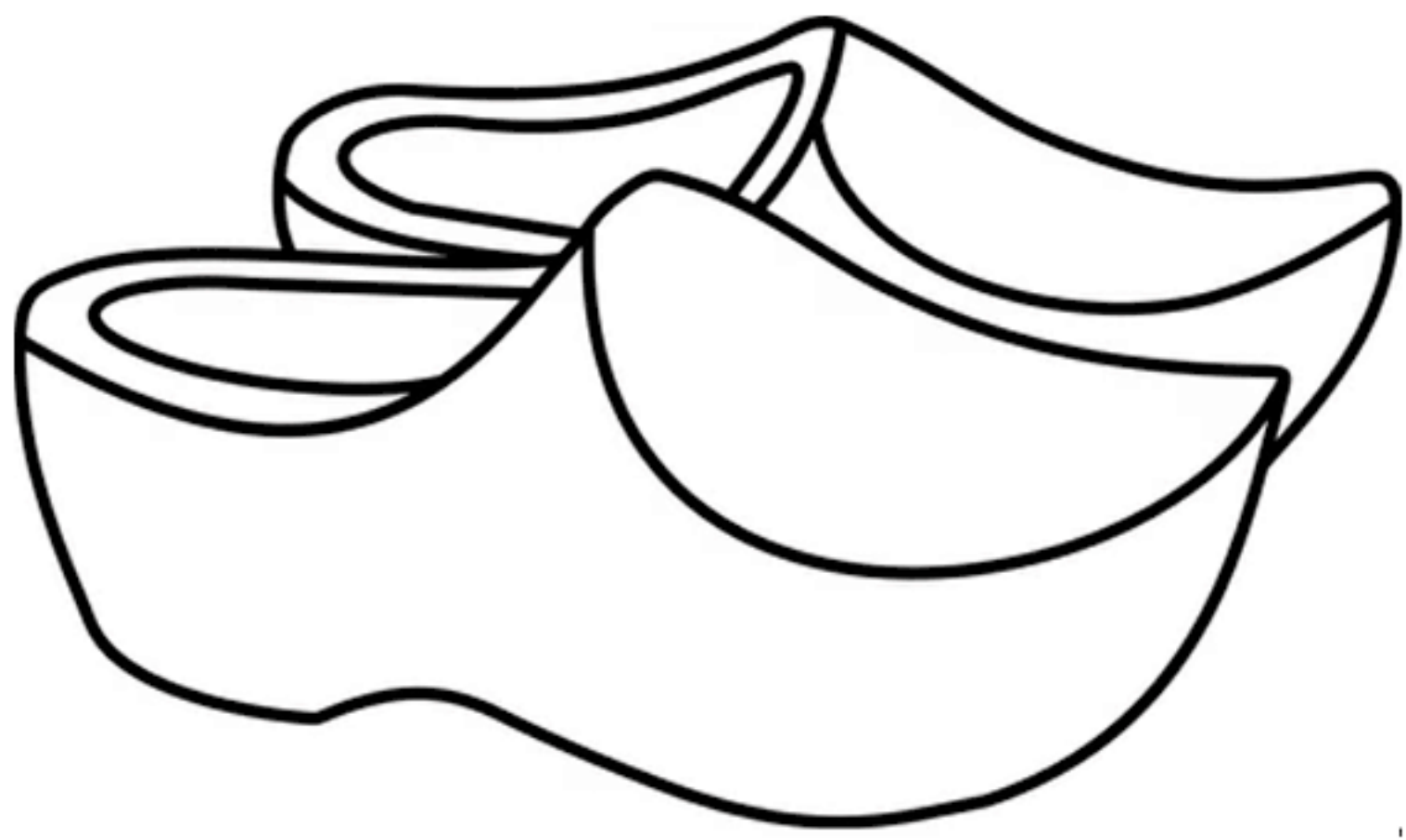

__CCOLI

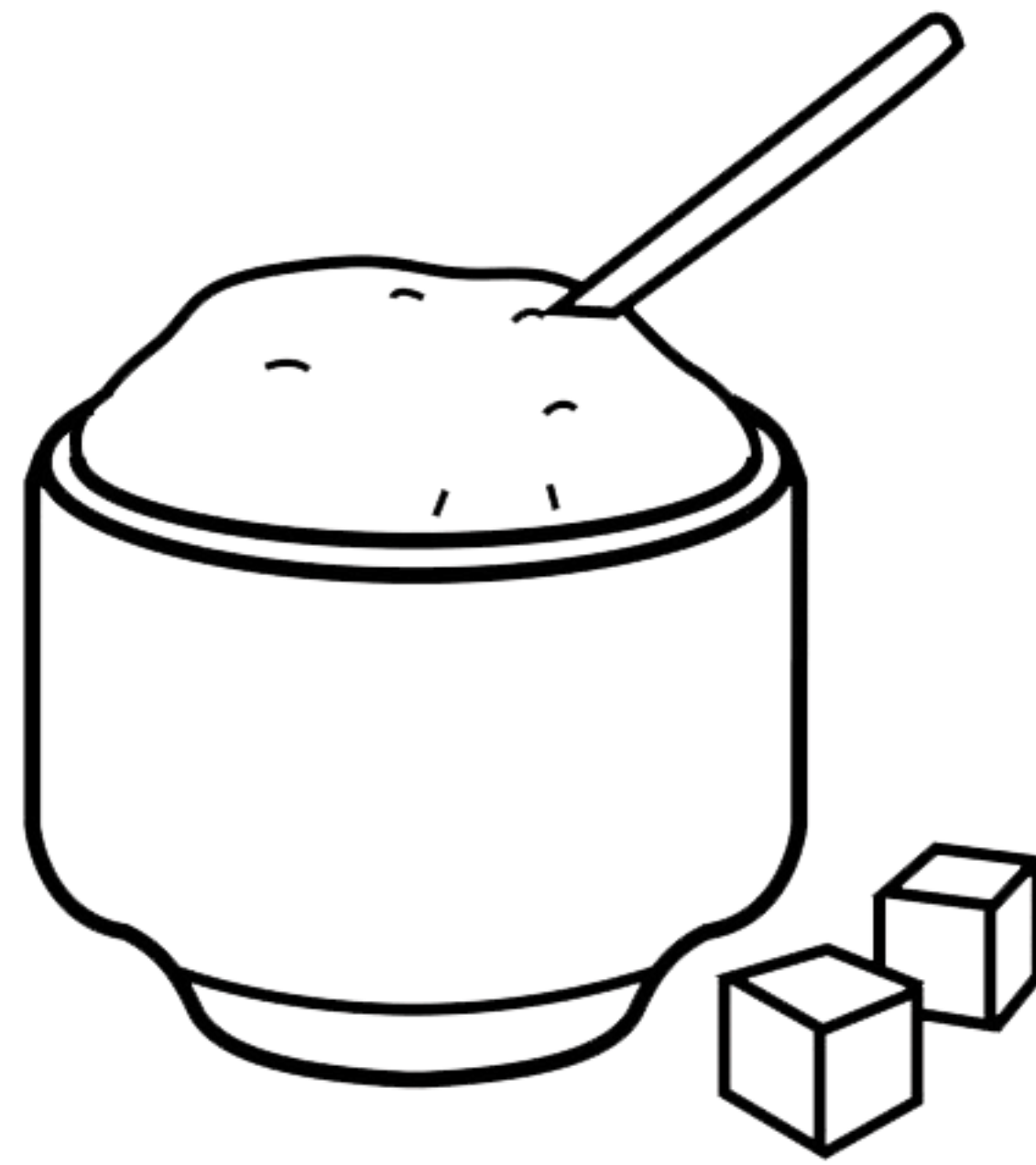

__CCHERO

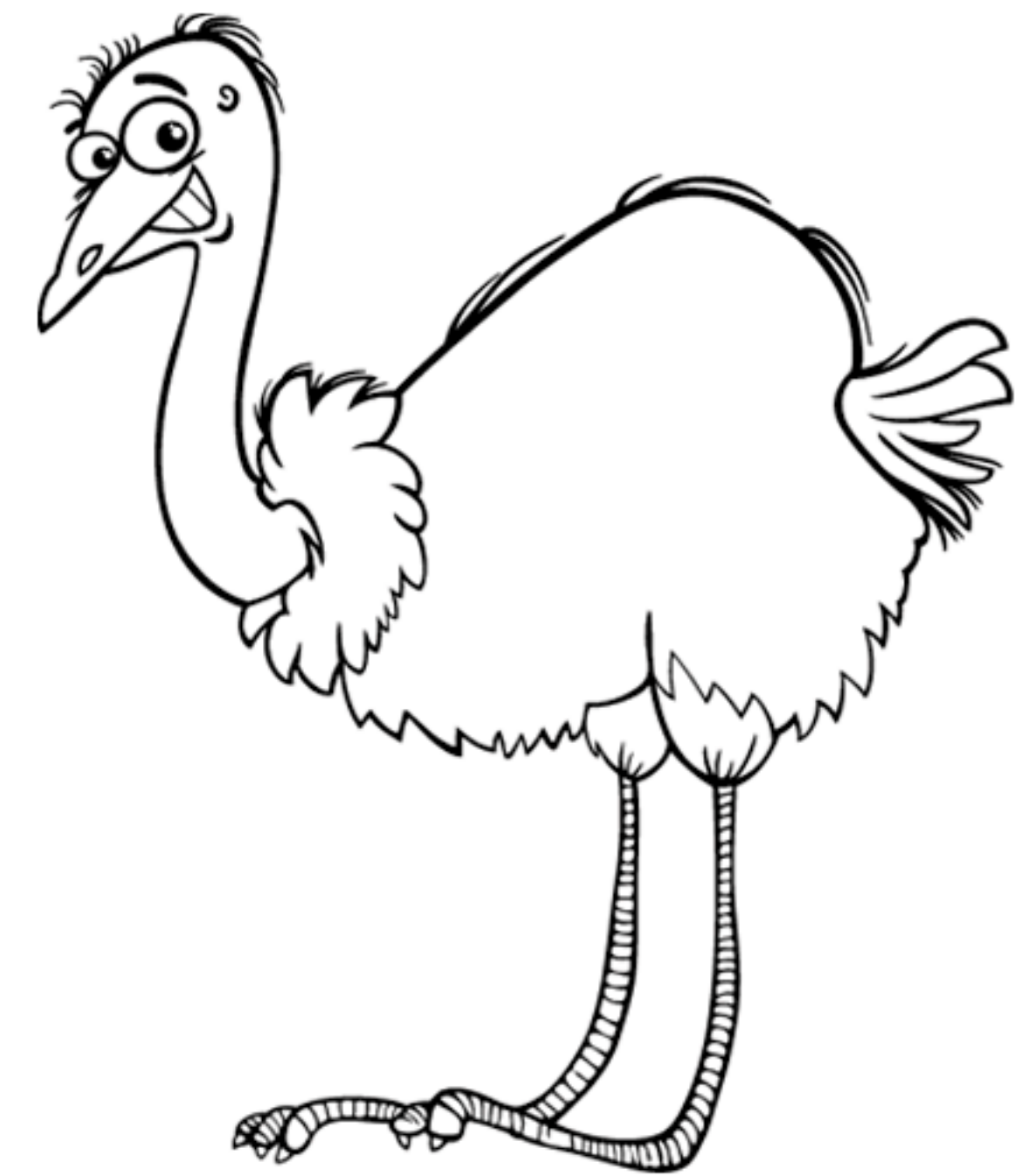

STRUZ__

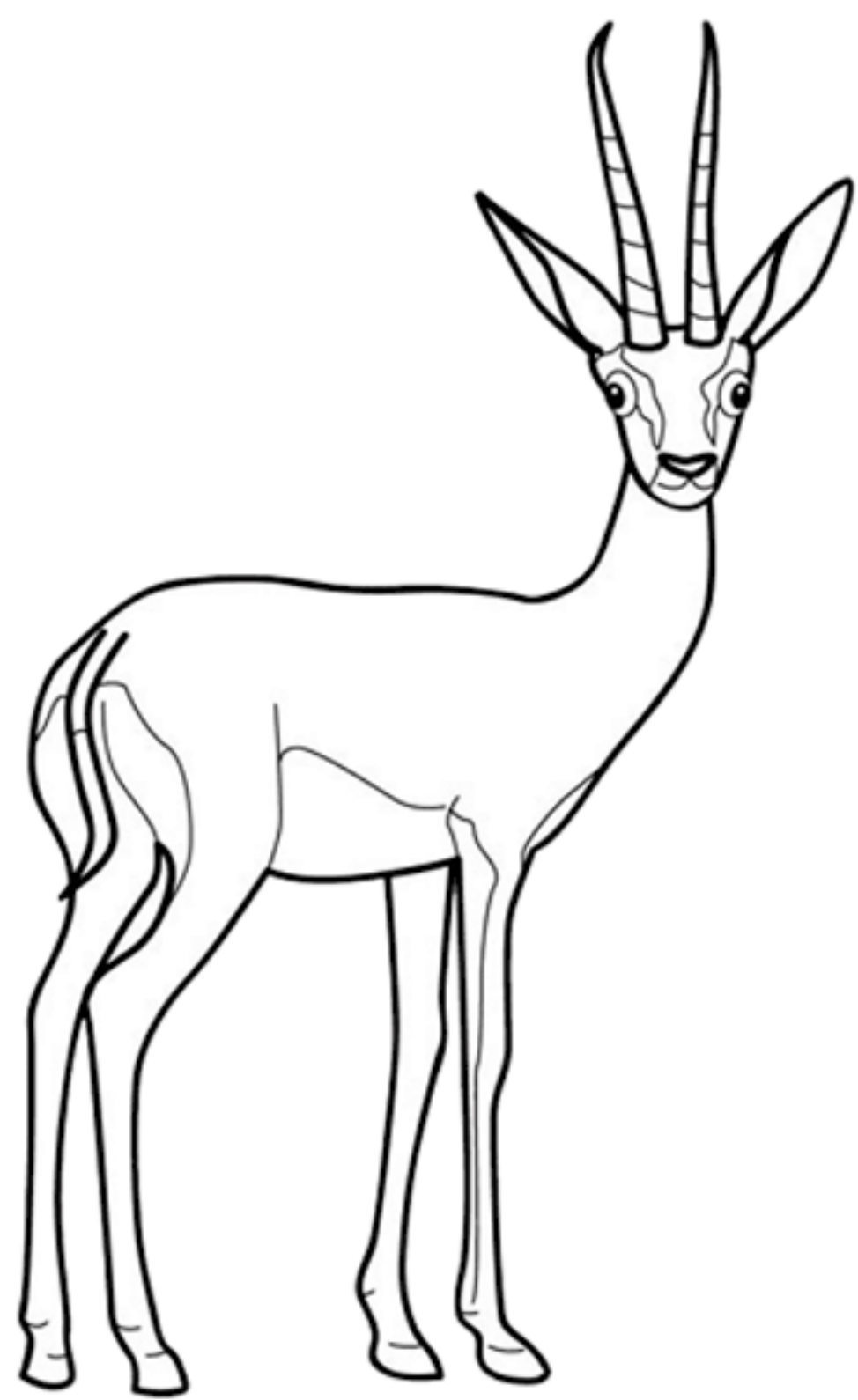

GAZ__LLA



MELAN__NA



AN__ANO

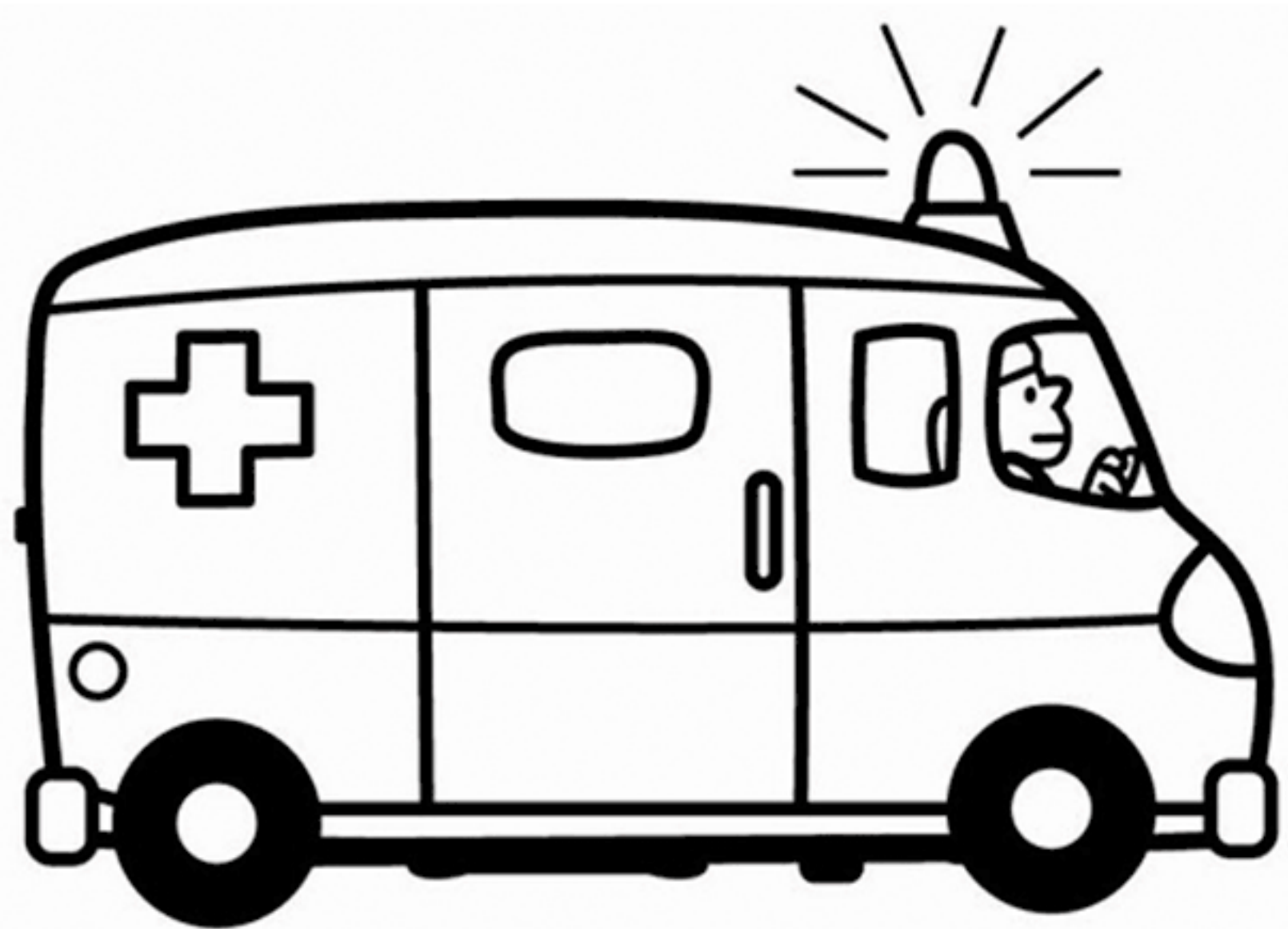

AMBULAN__

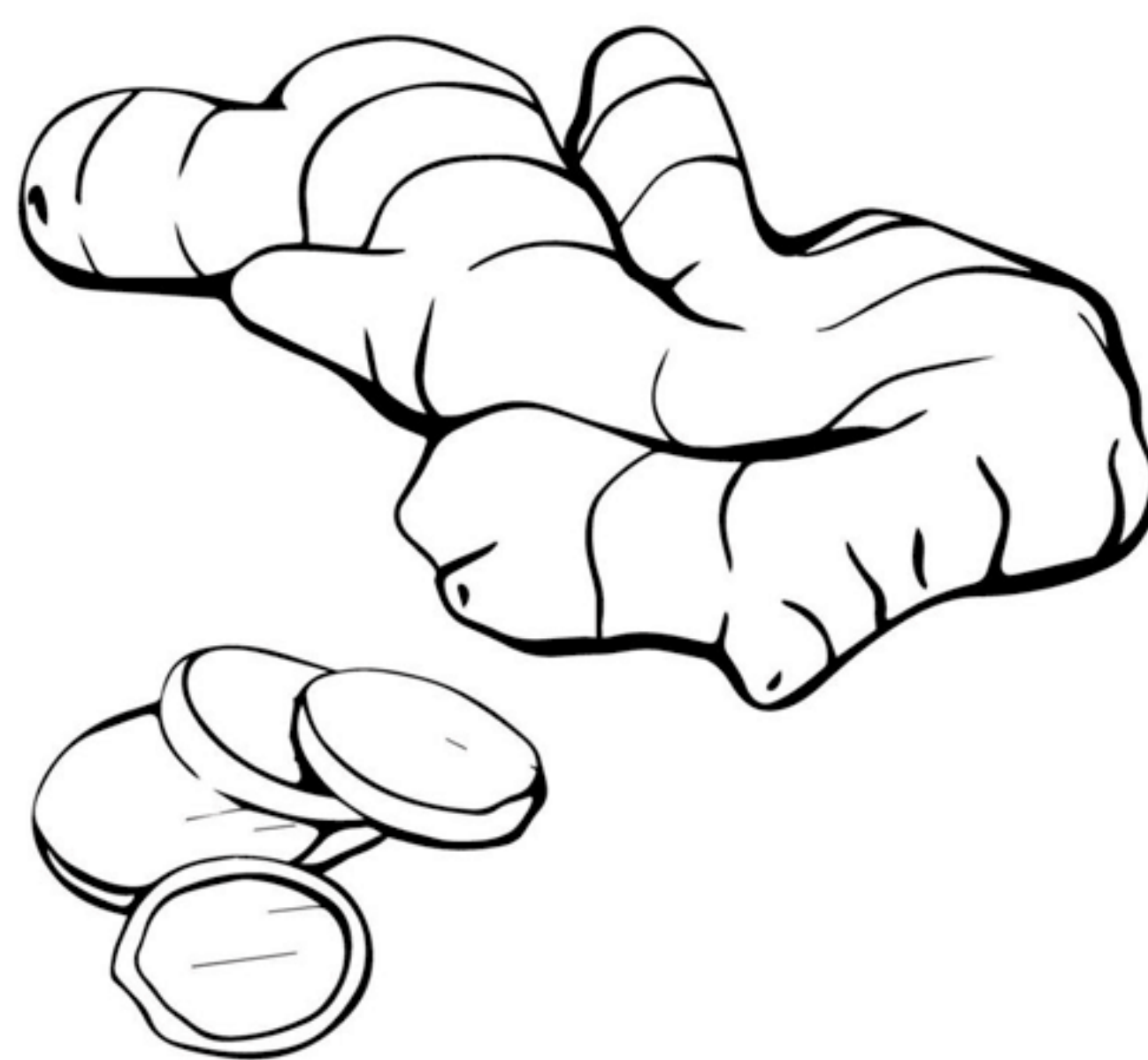

__N__RO

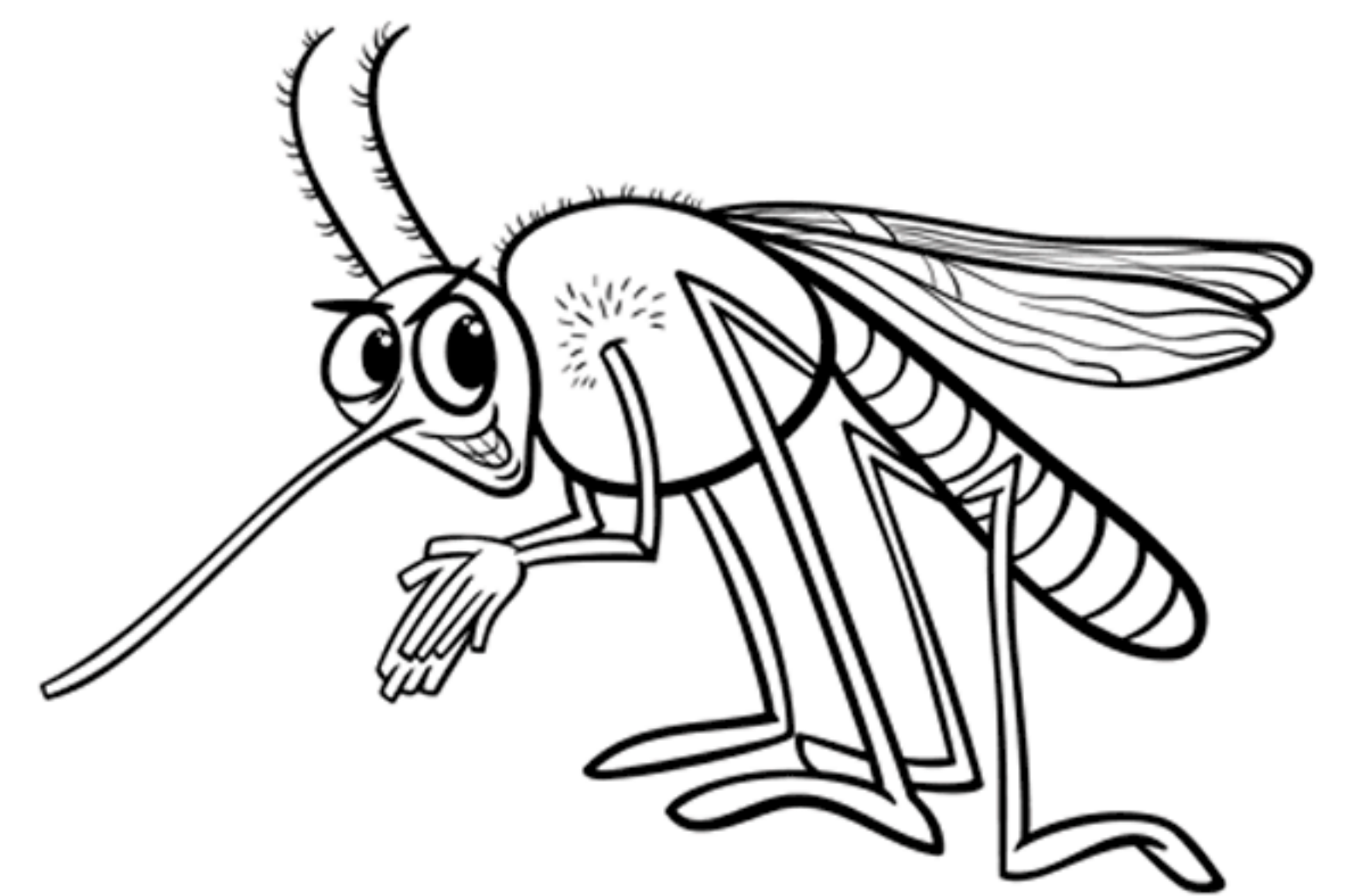

__N__RA

ZA ZE ZI ZO ZU

- RIORDINA LE SILLABE NEI CERCHI E SCRIVI LA PAROLA. POI COLLEGA OGNI PAROLA AL DISEGNO GIUSTO.

ZI CAL NI →

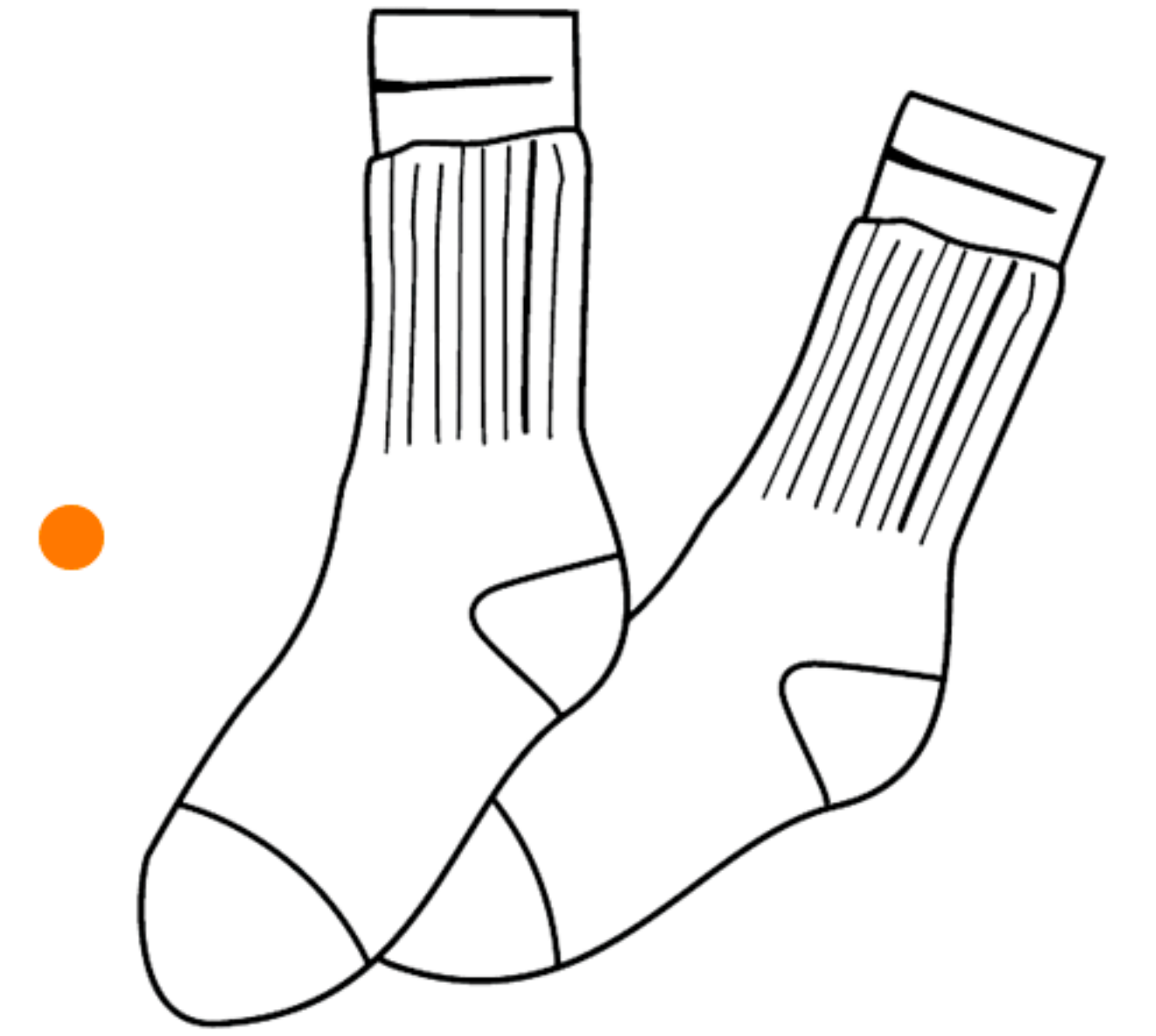

ZUC CHI NA →



NO ZER BI →

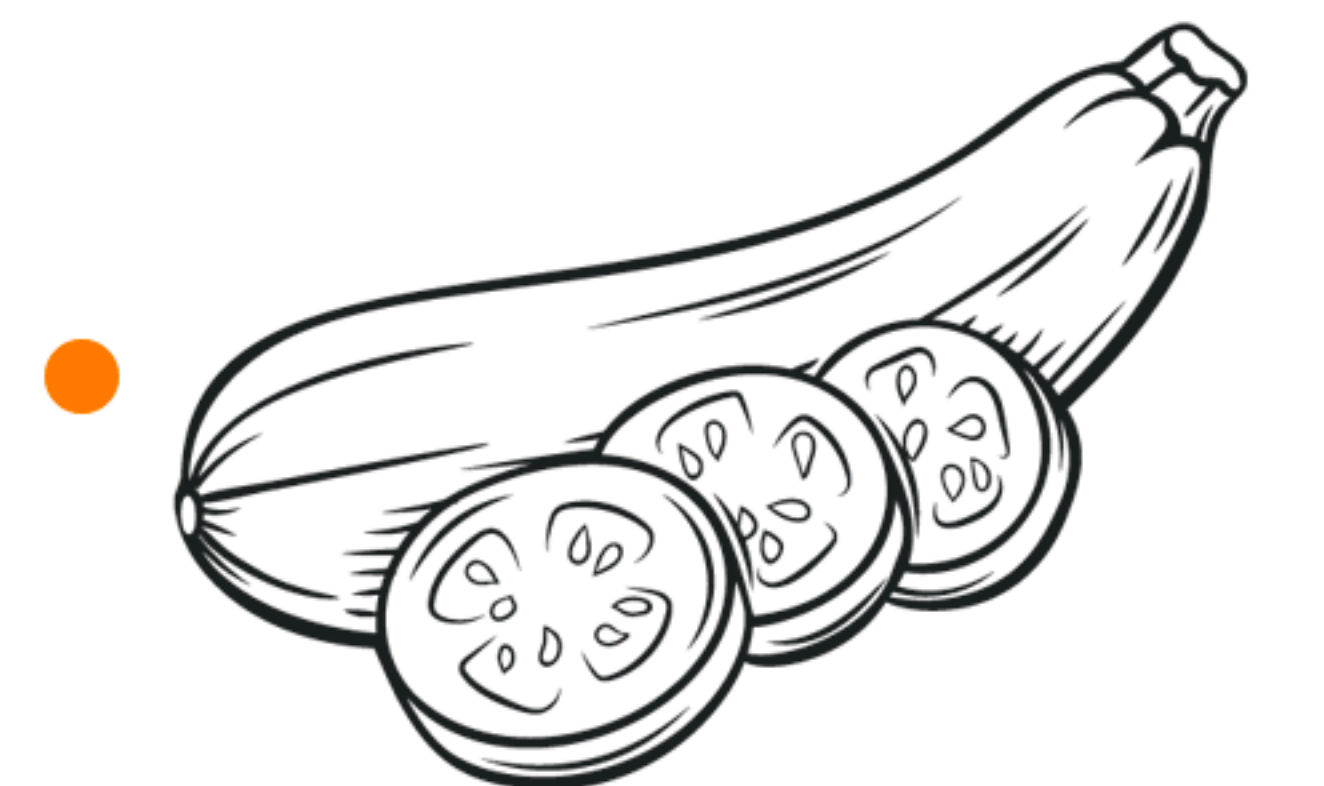

NE ZO CAL →

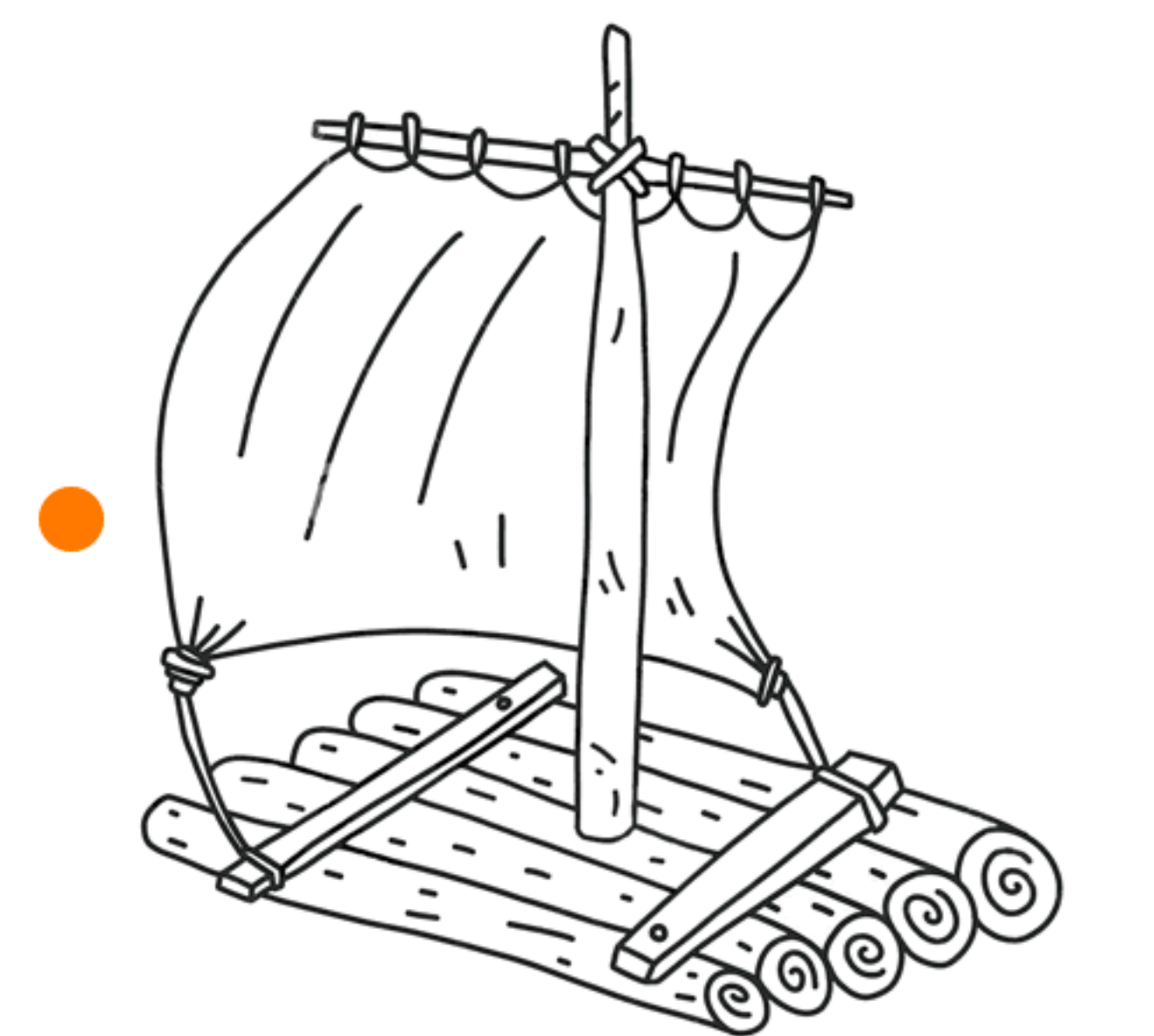

TE ZAT RA →

