

# Addizioni con i disegni

- Conta, somma e scrivi il risultato nel riquadro di destra.

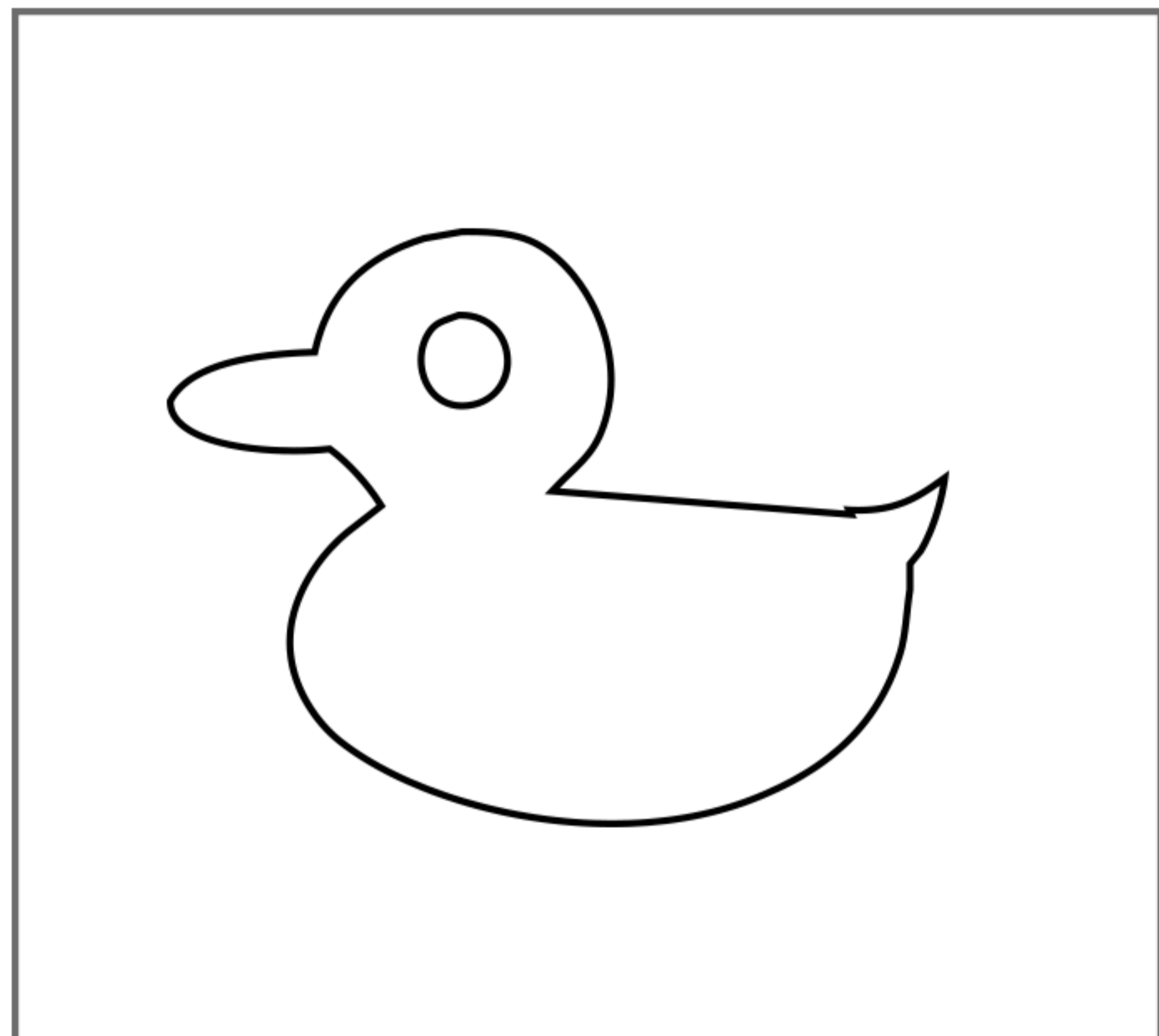

+

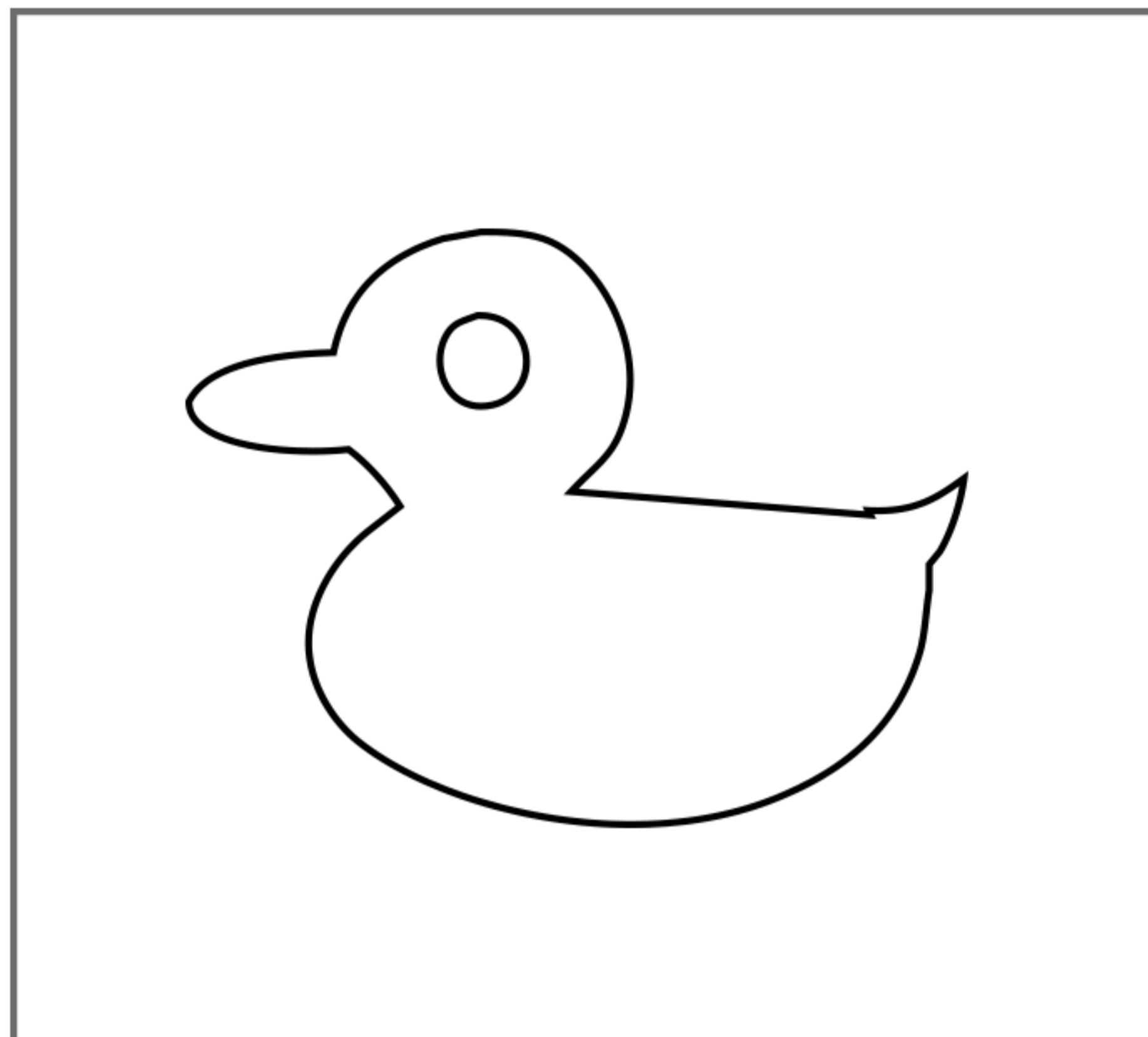

=

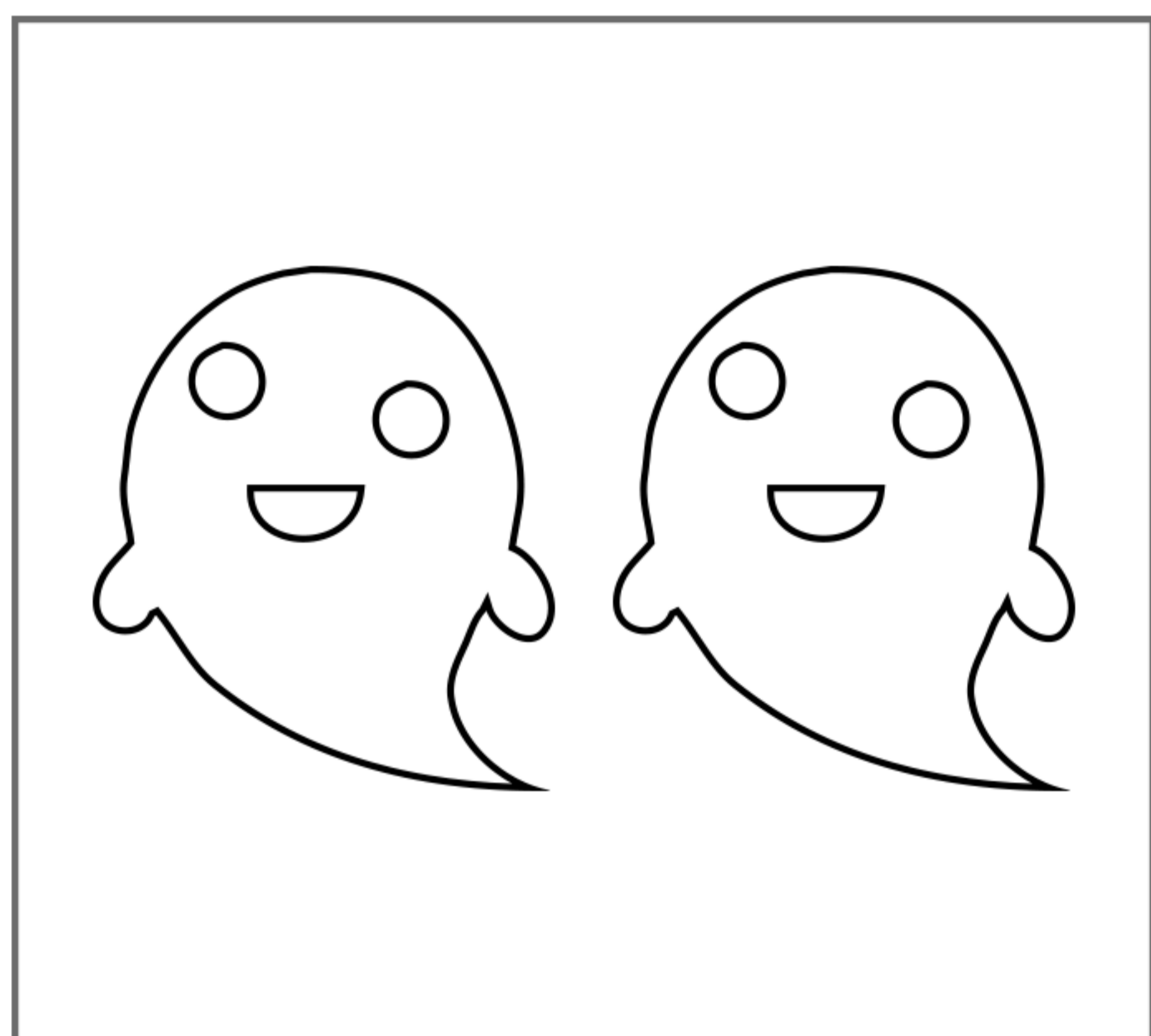
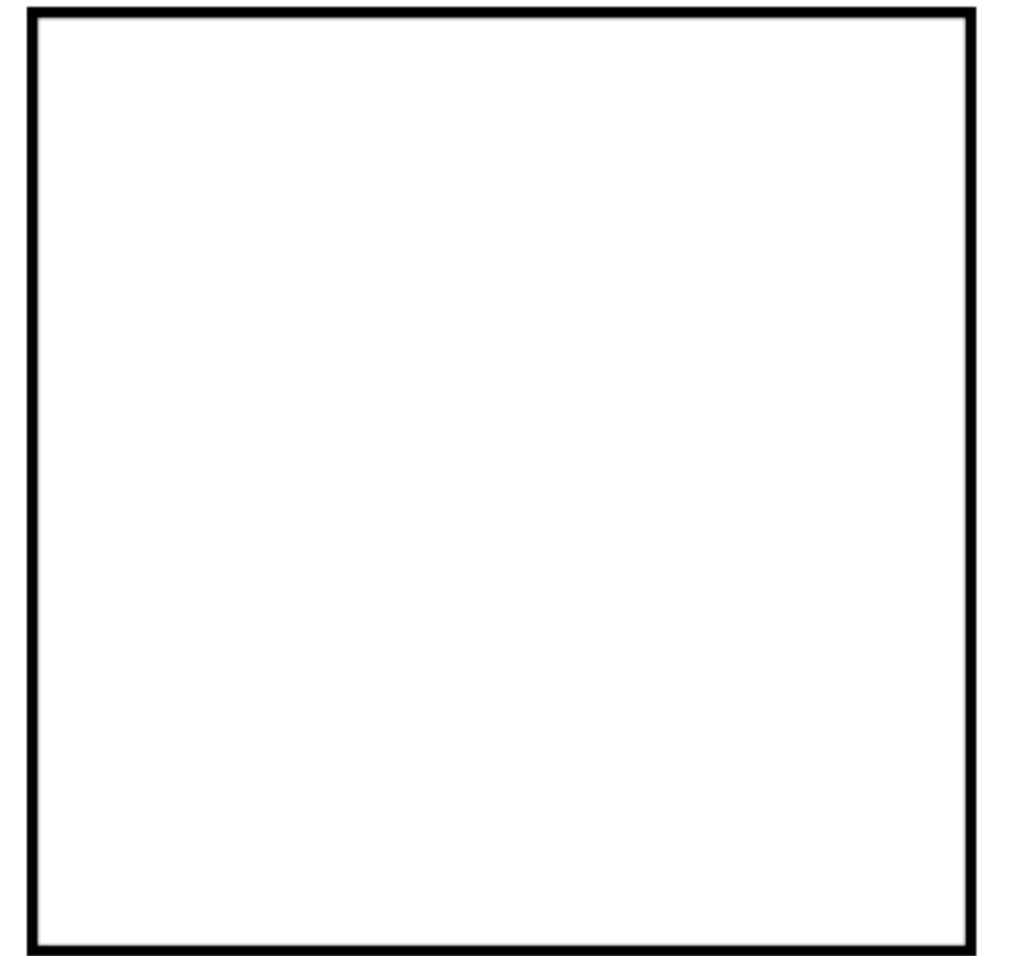

+

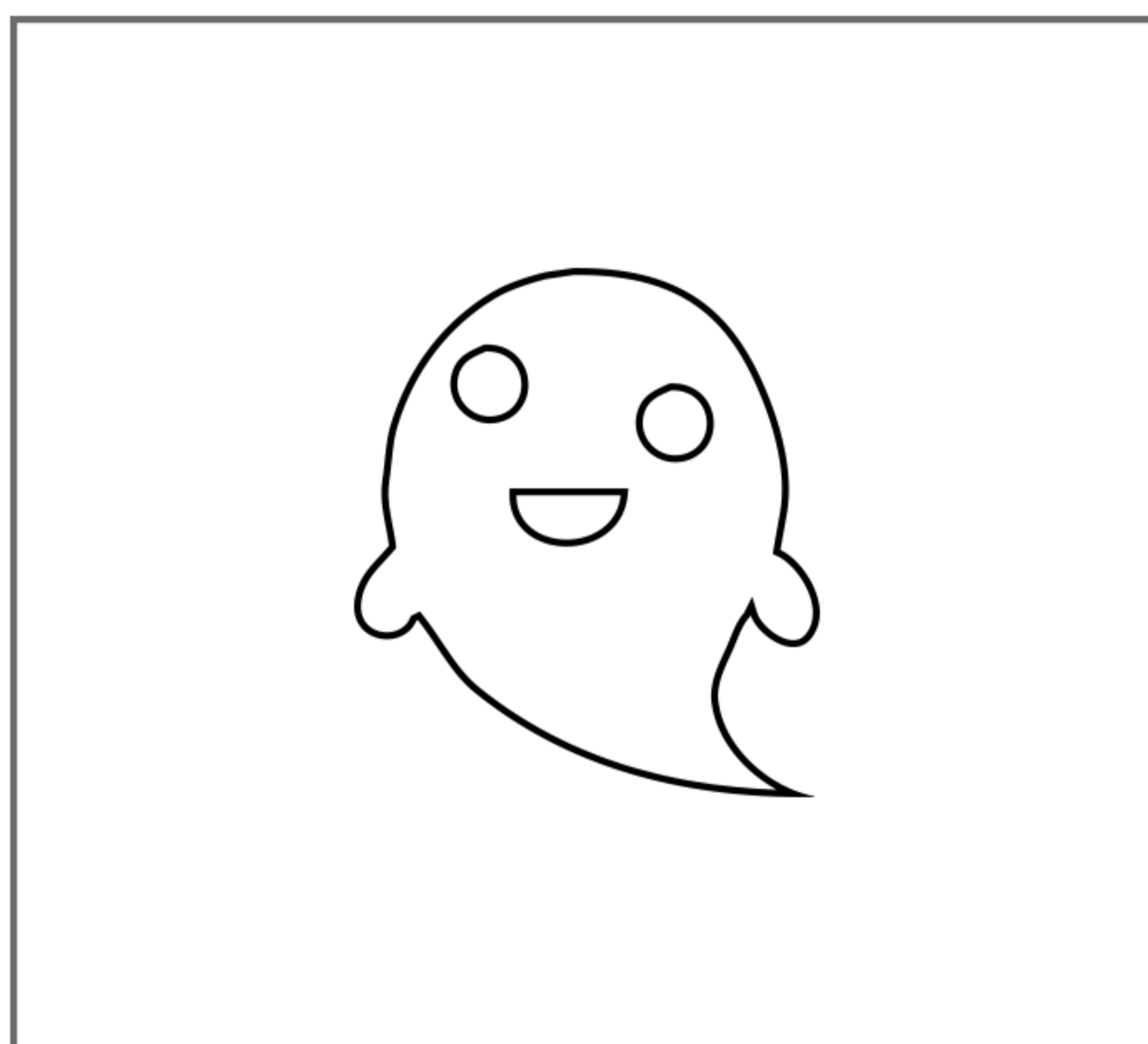

=

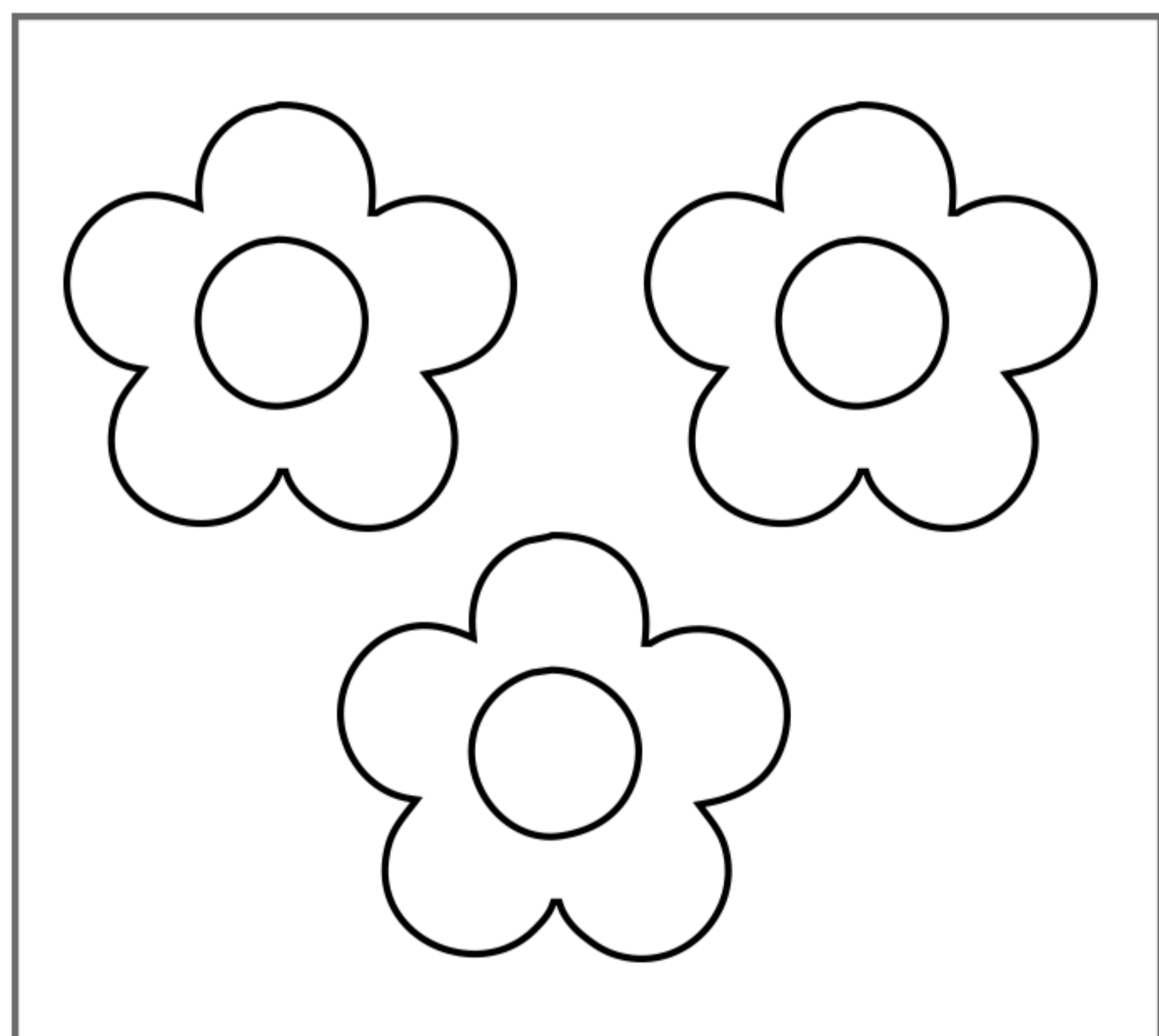
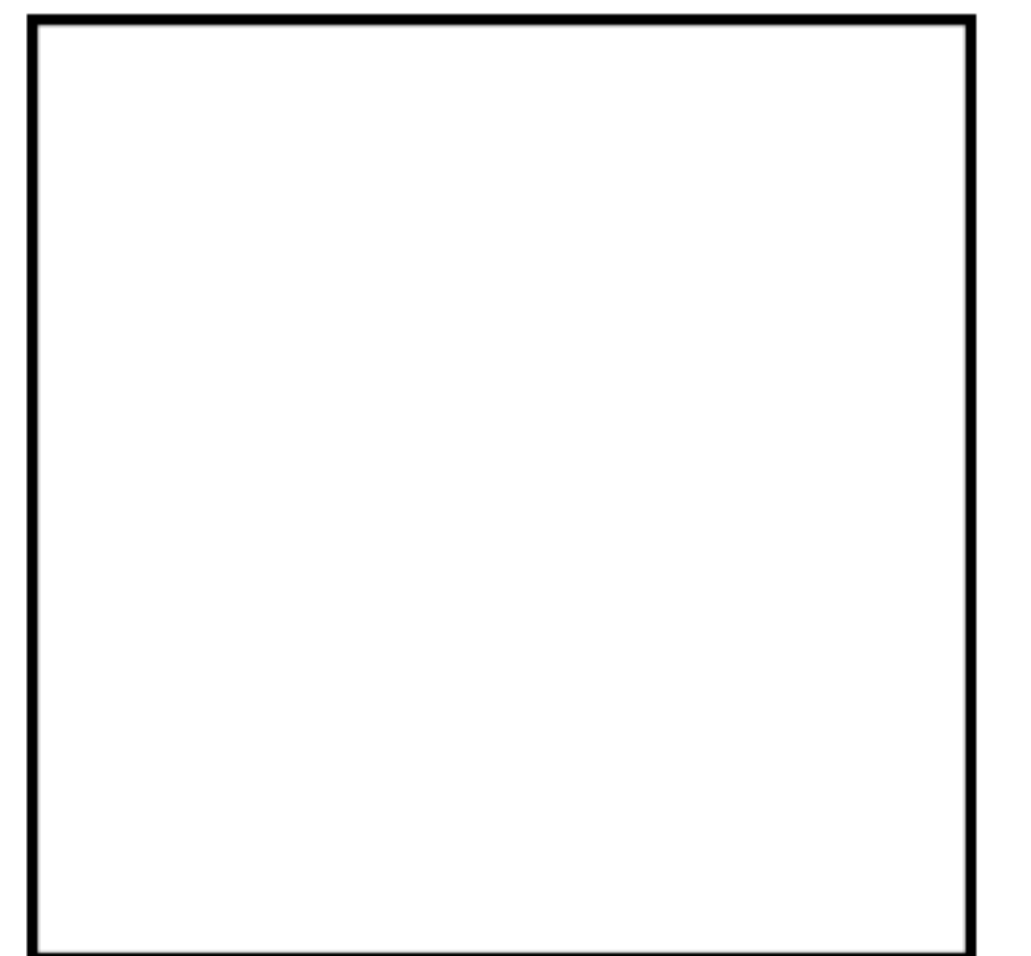

+

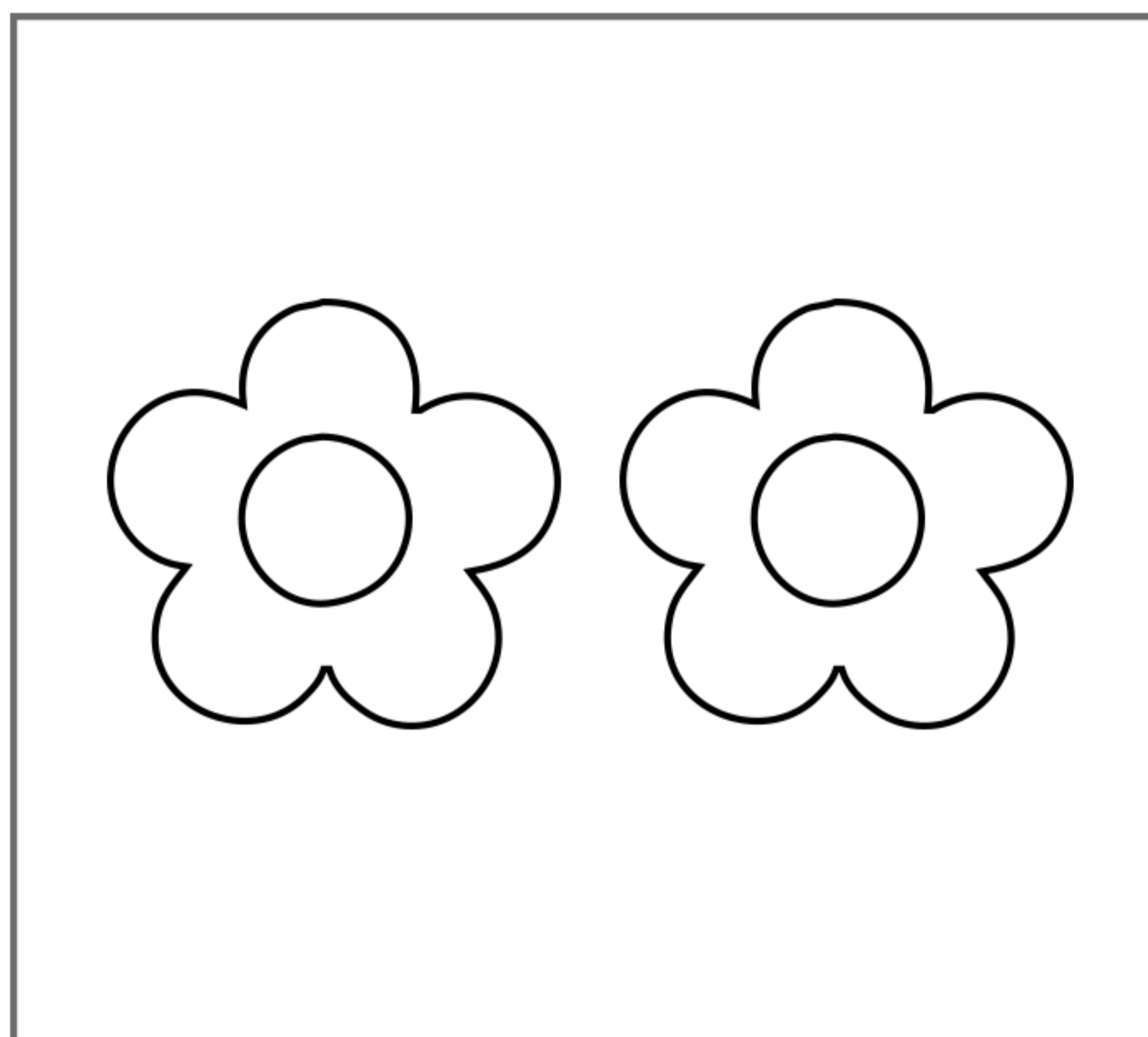

=

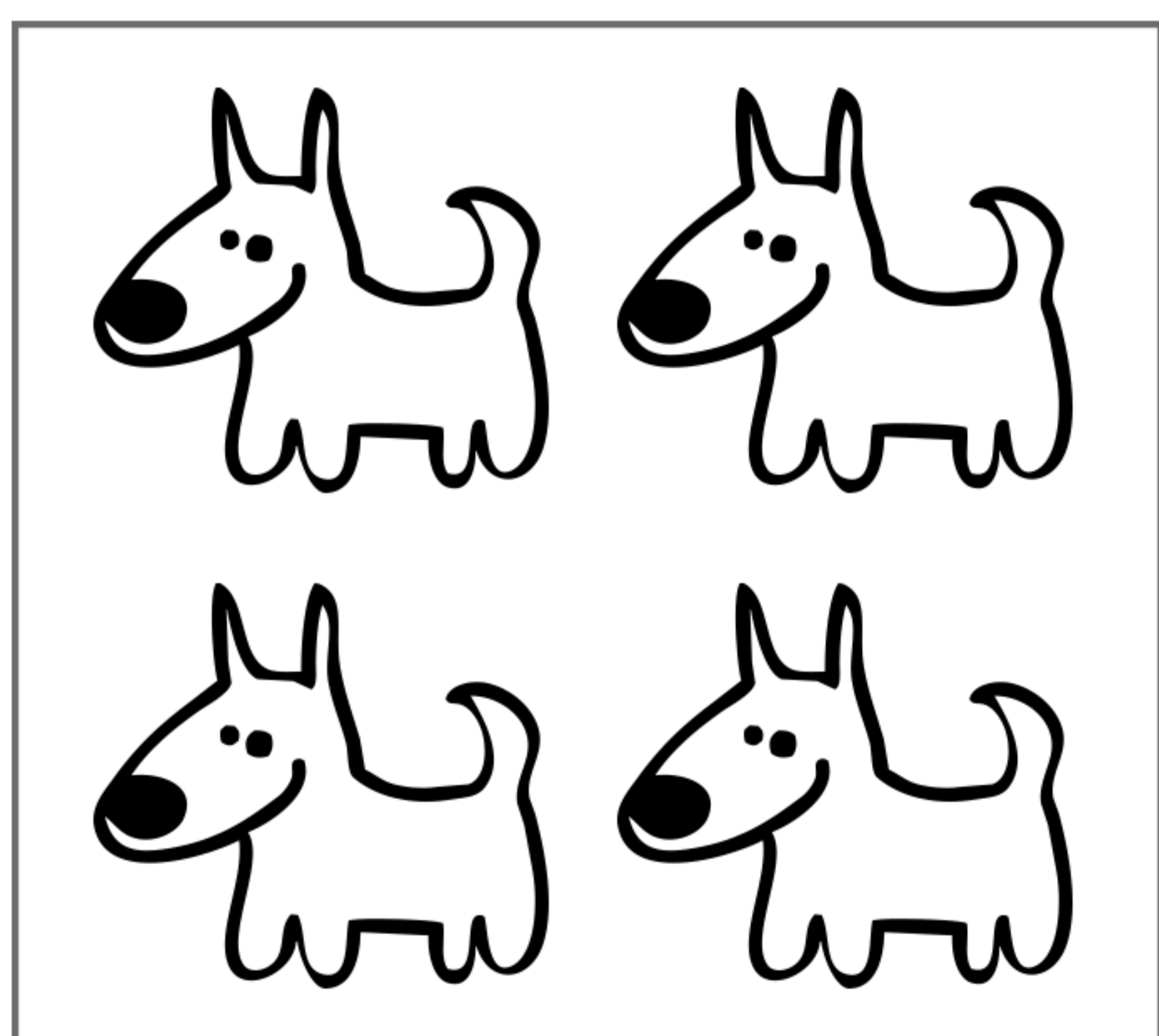
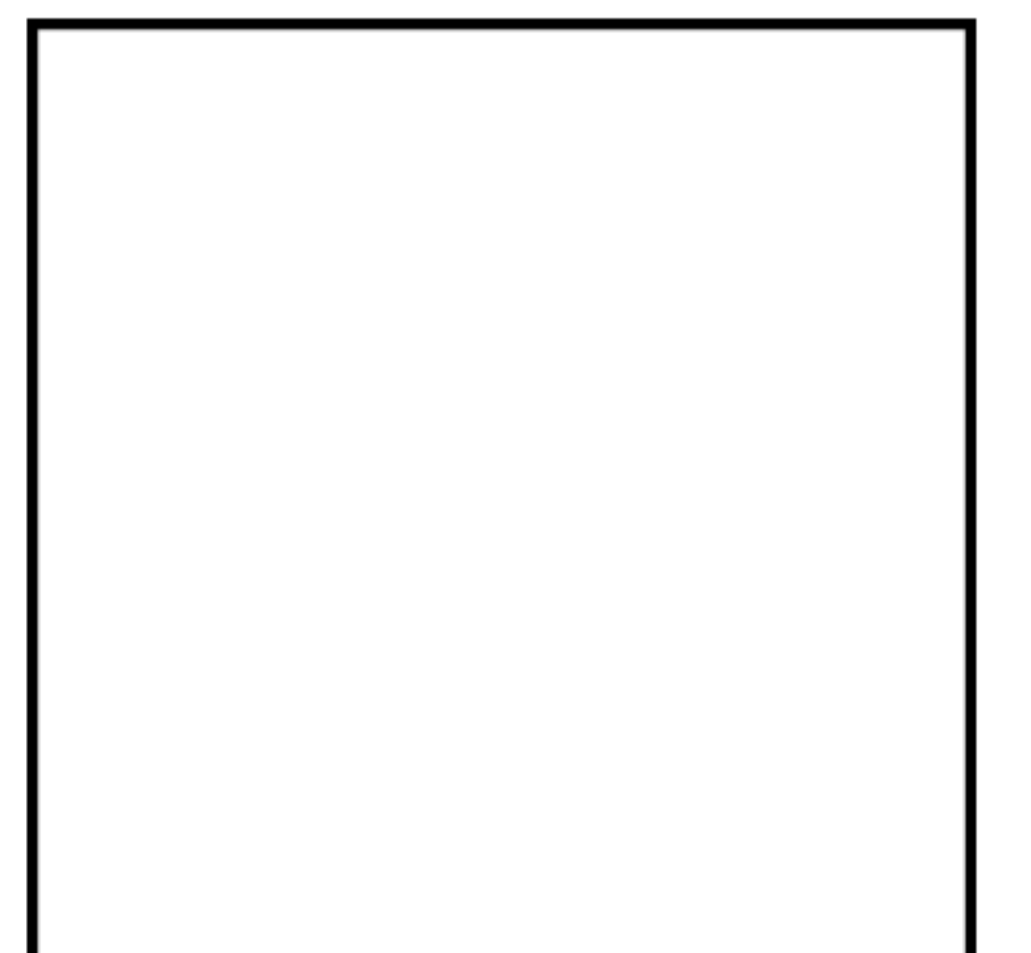

+

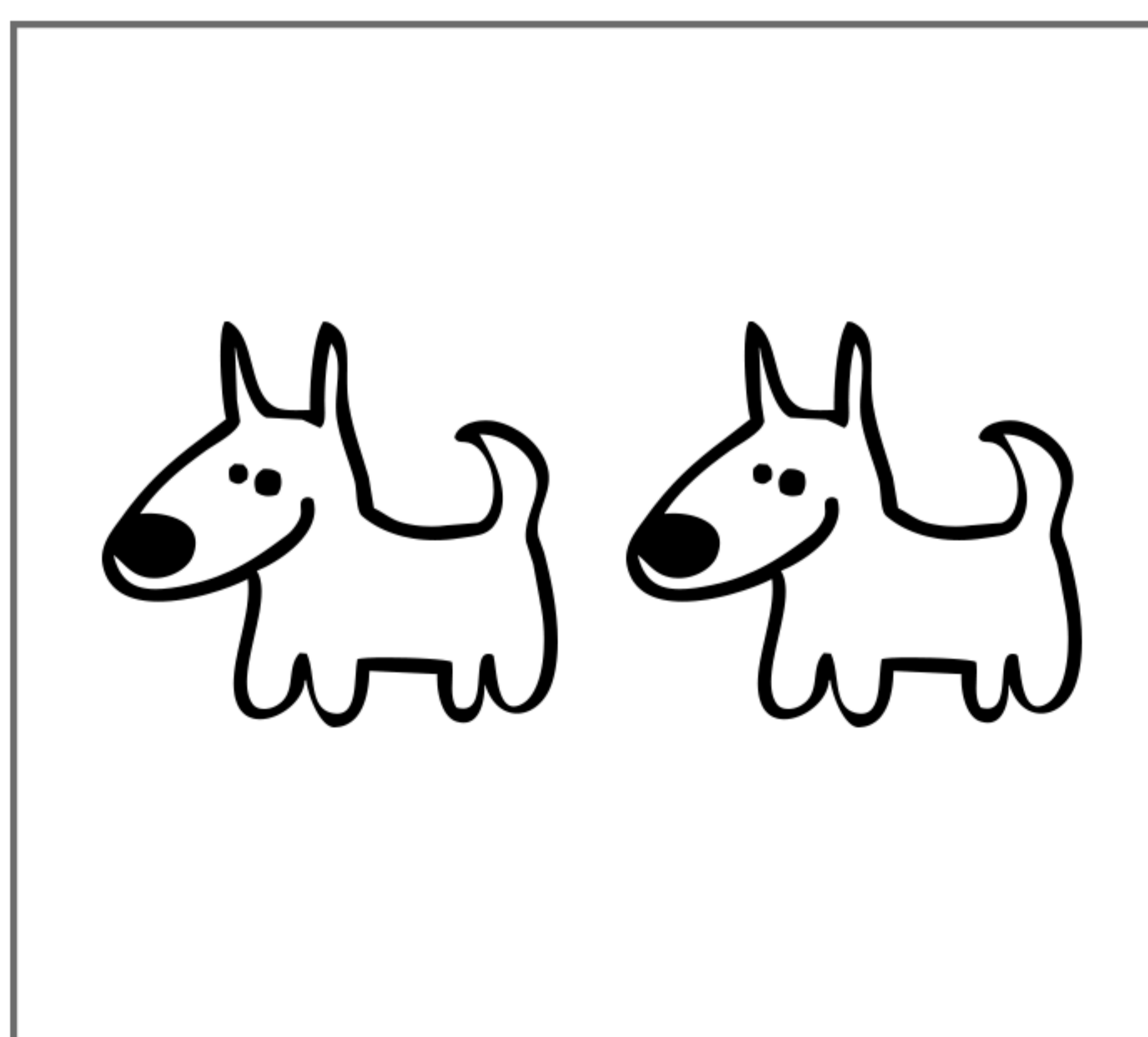

=

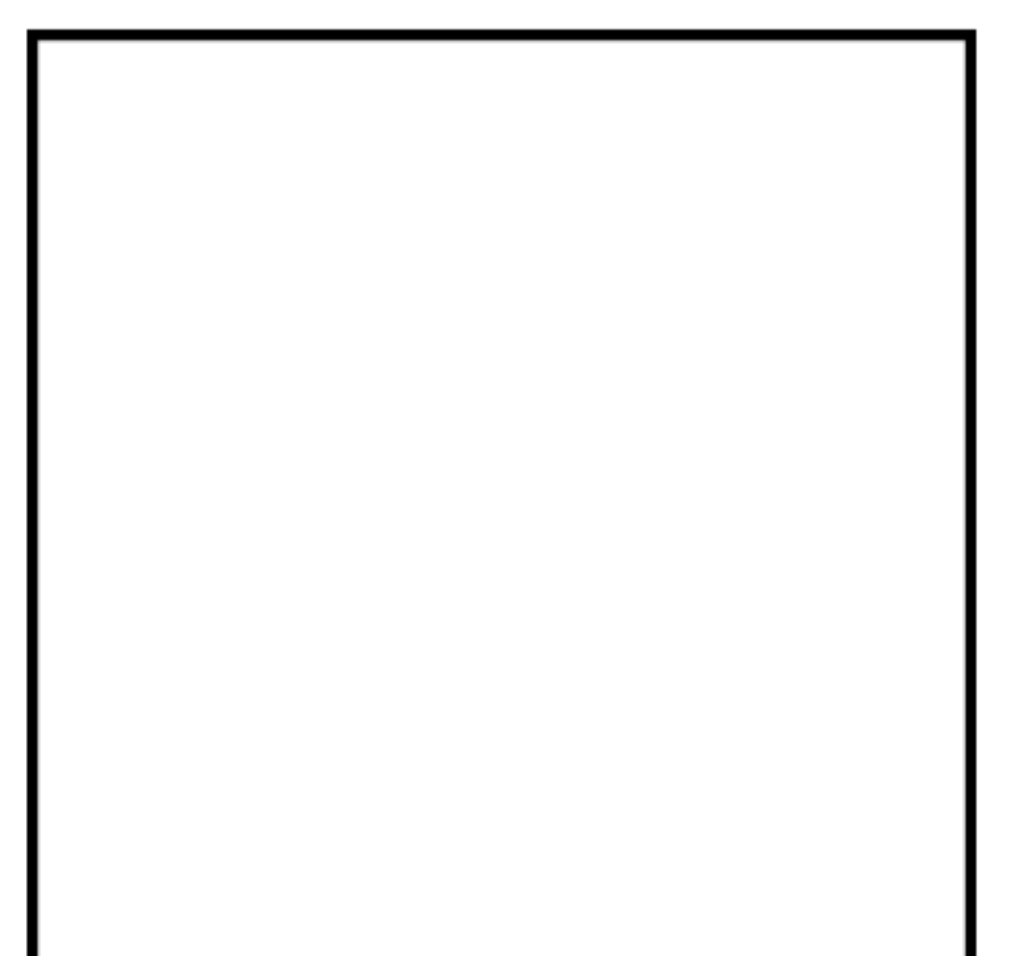

# Addizioni con i disegni

- Conta, somma e scrivi il risultato nel riquadro di destra.

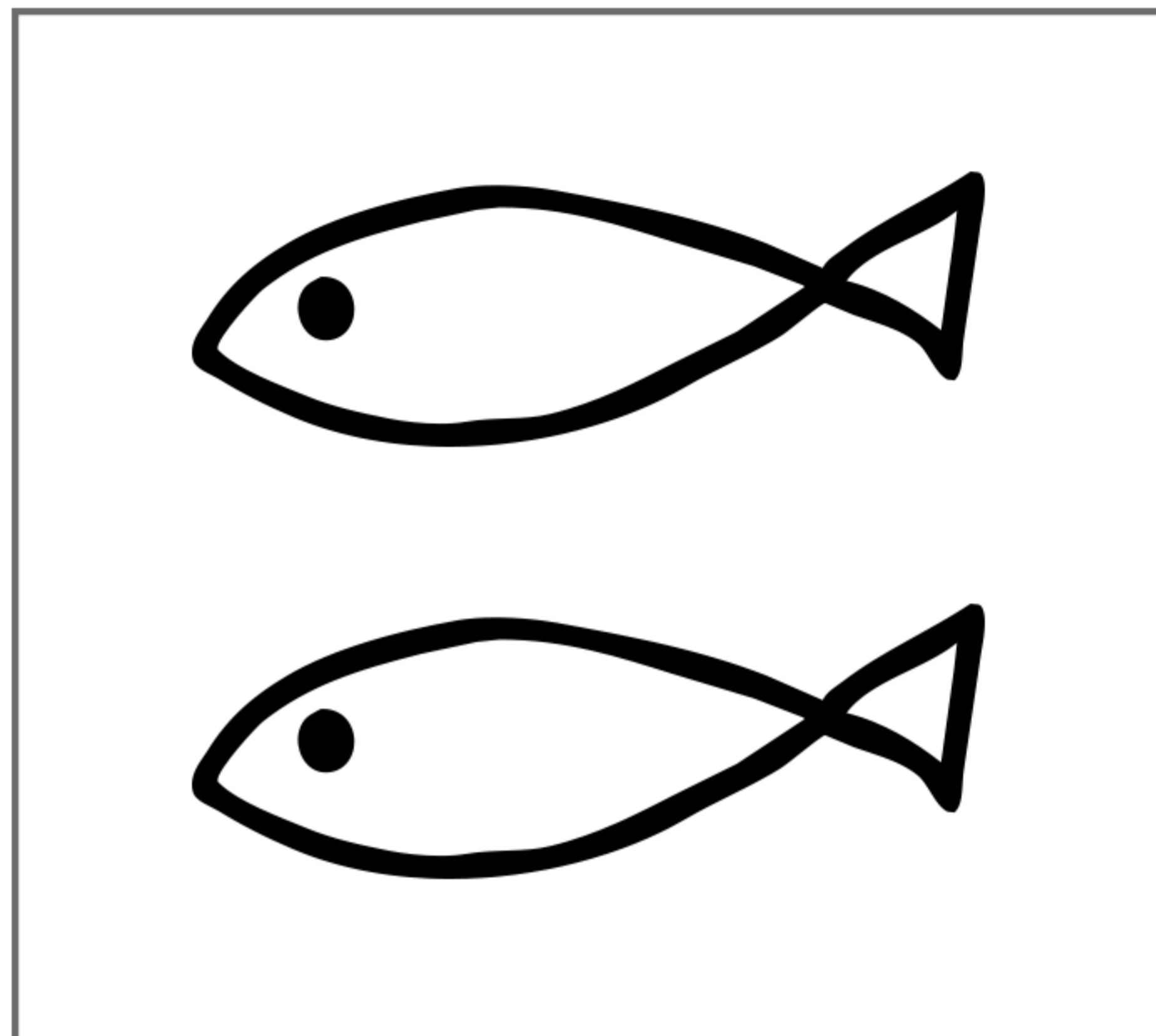

+

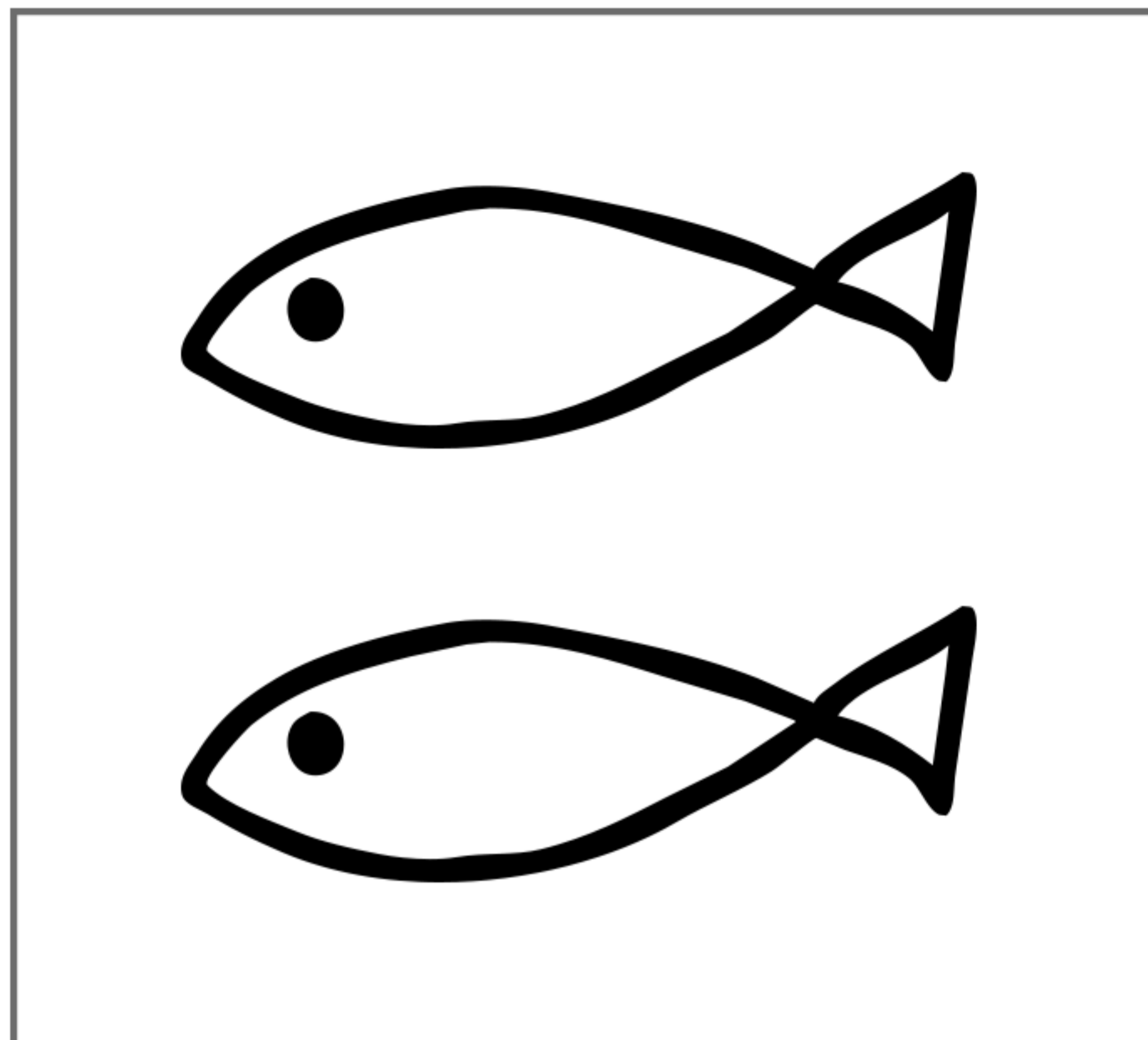

=

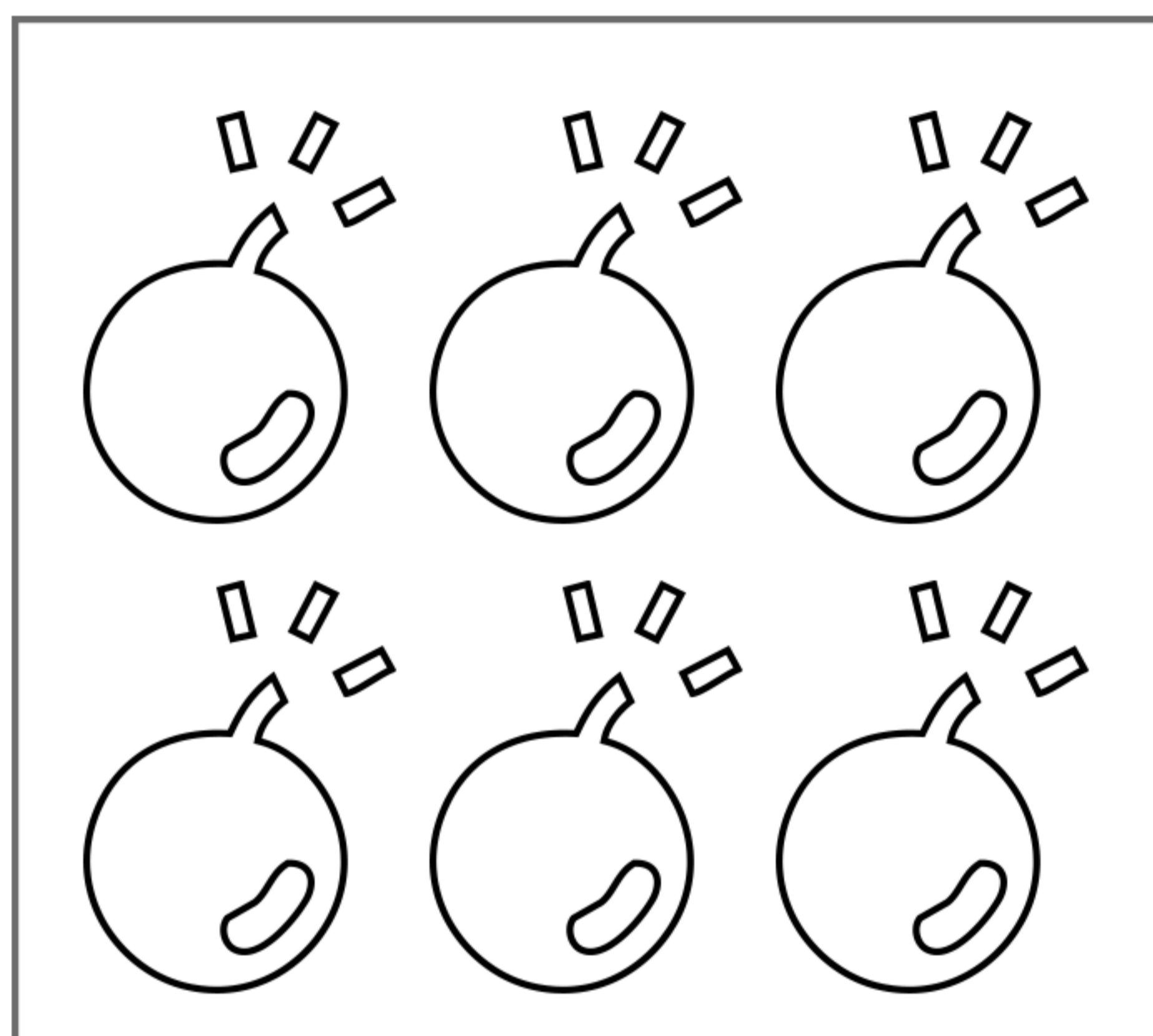
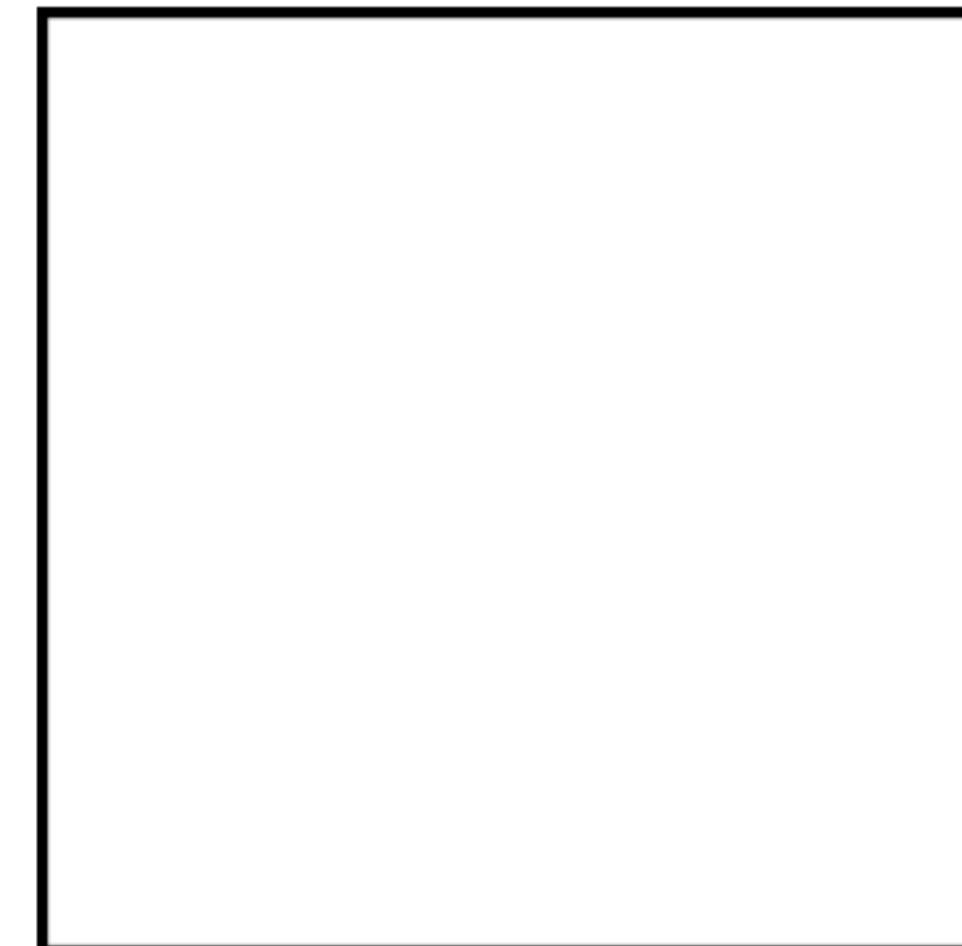

+

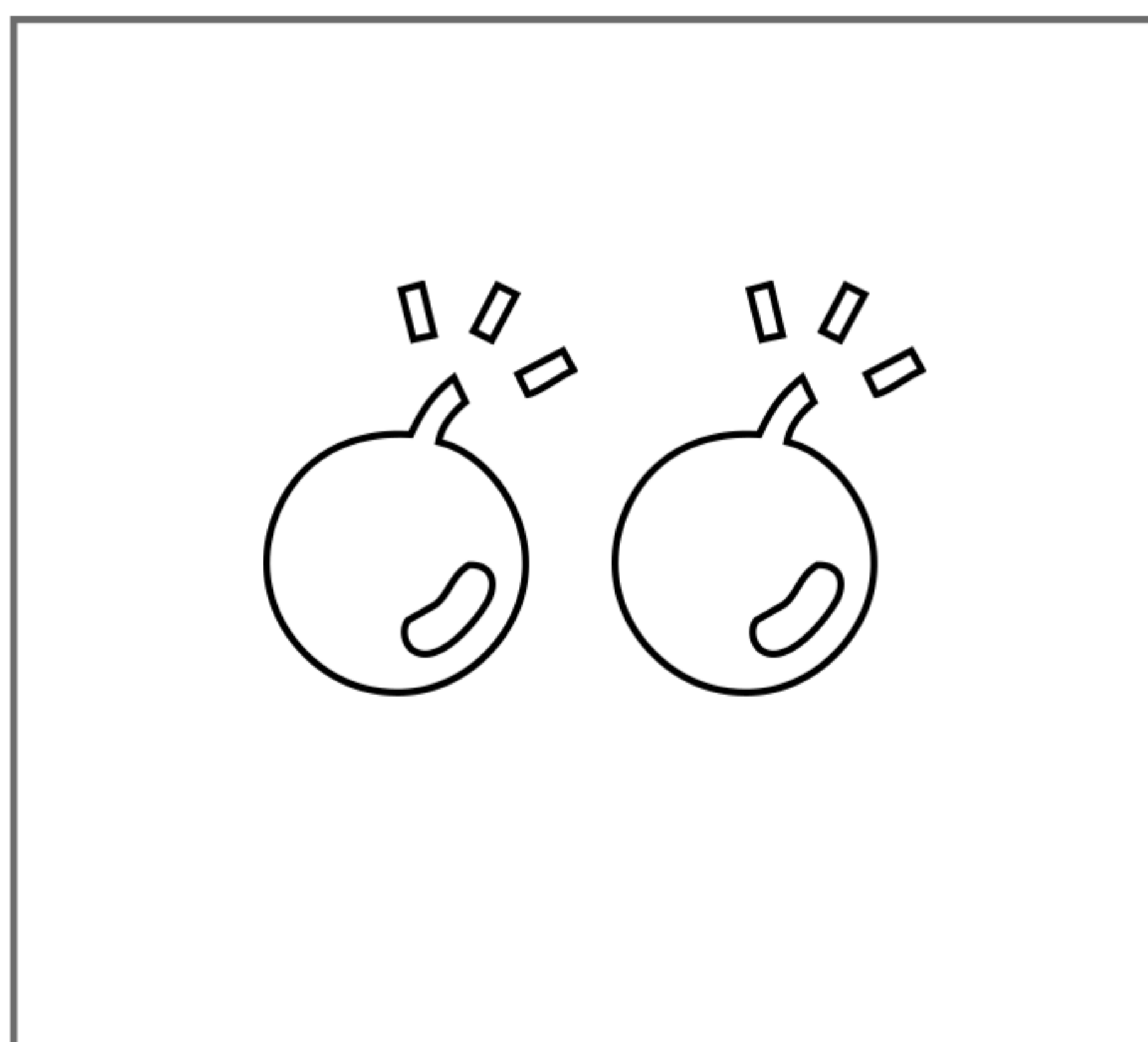

=

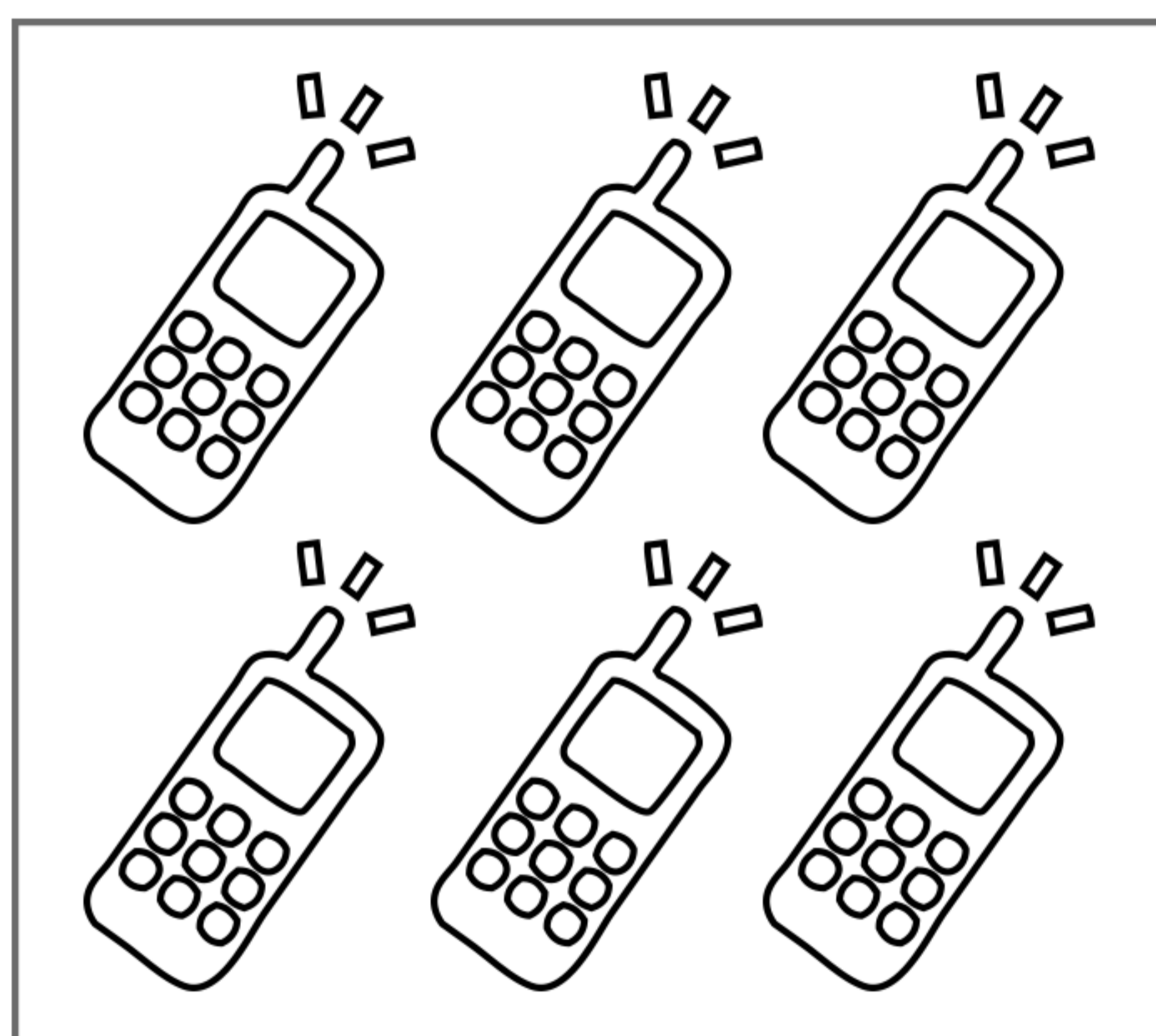
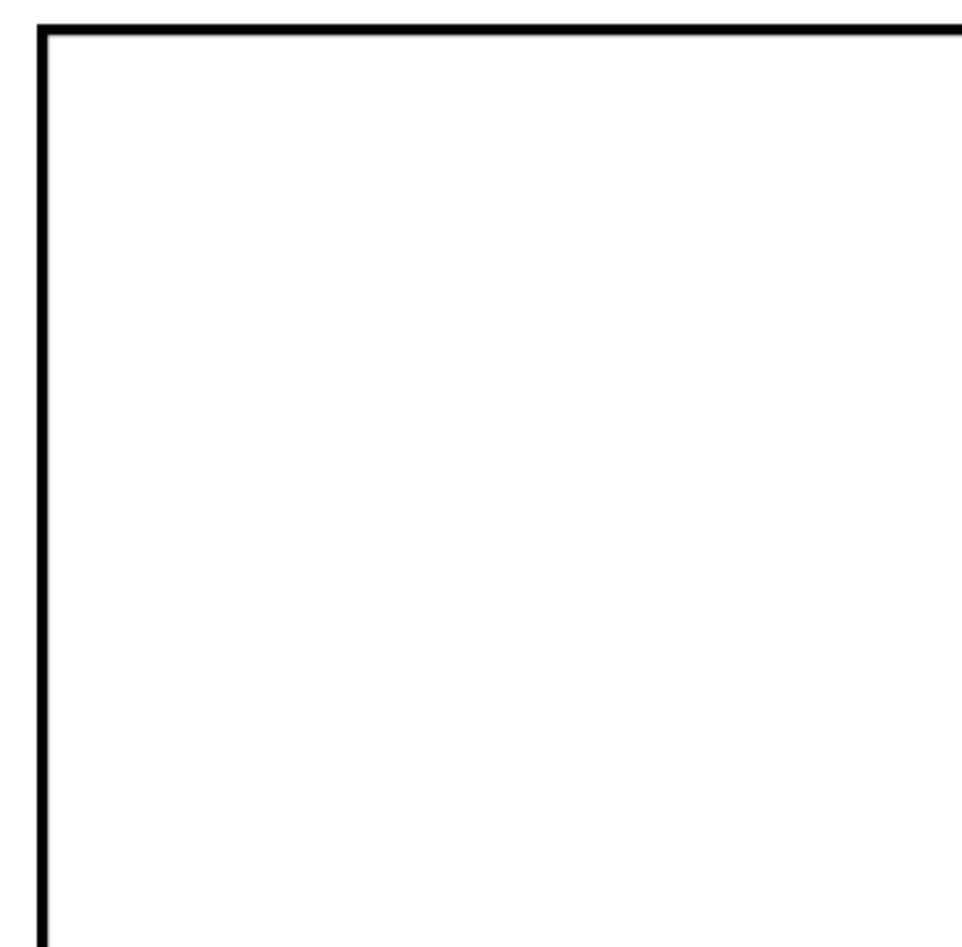

+

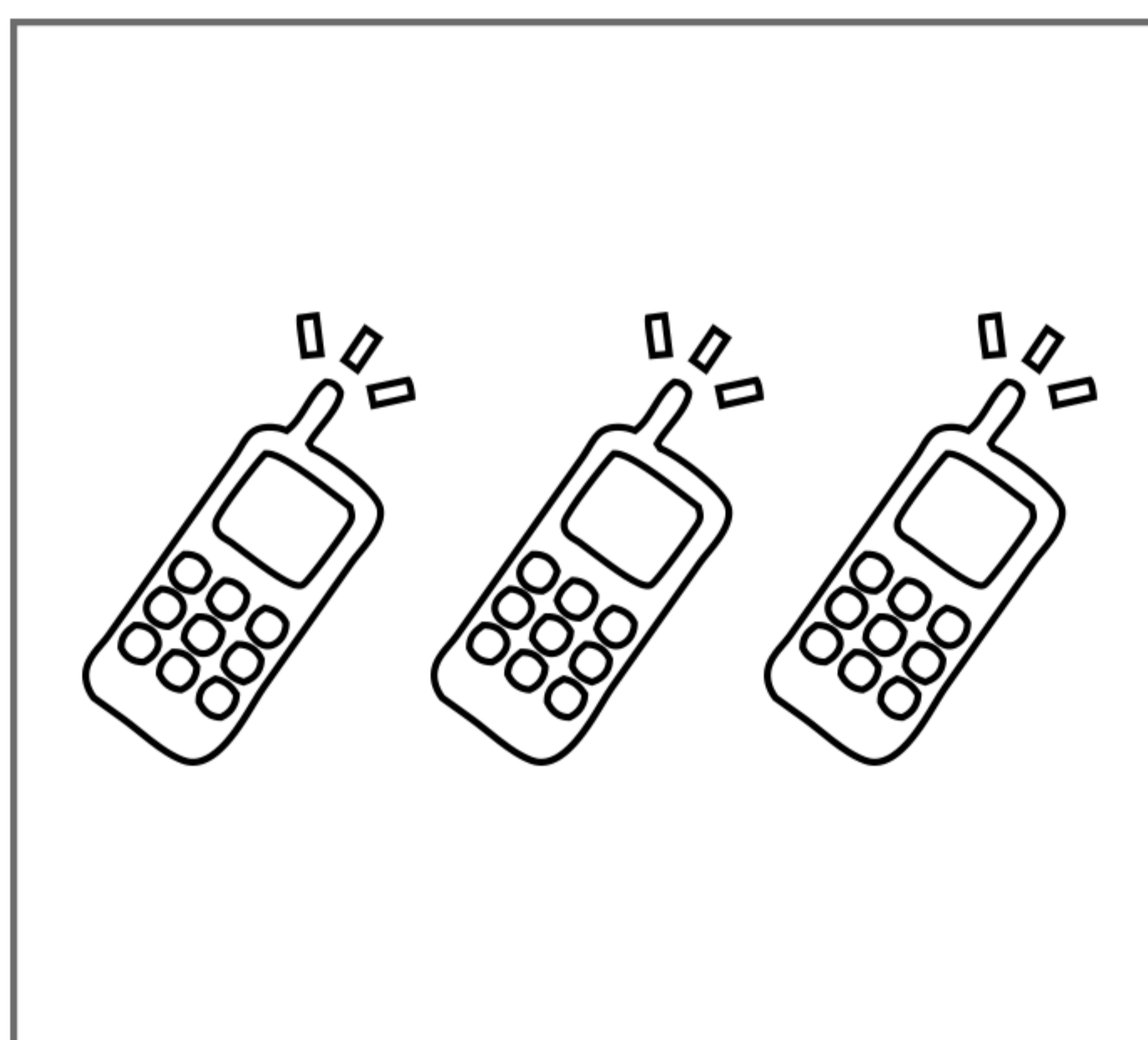

=

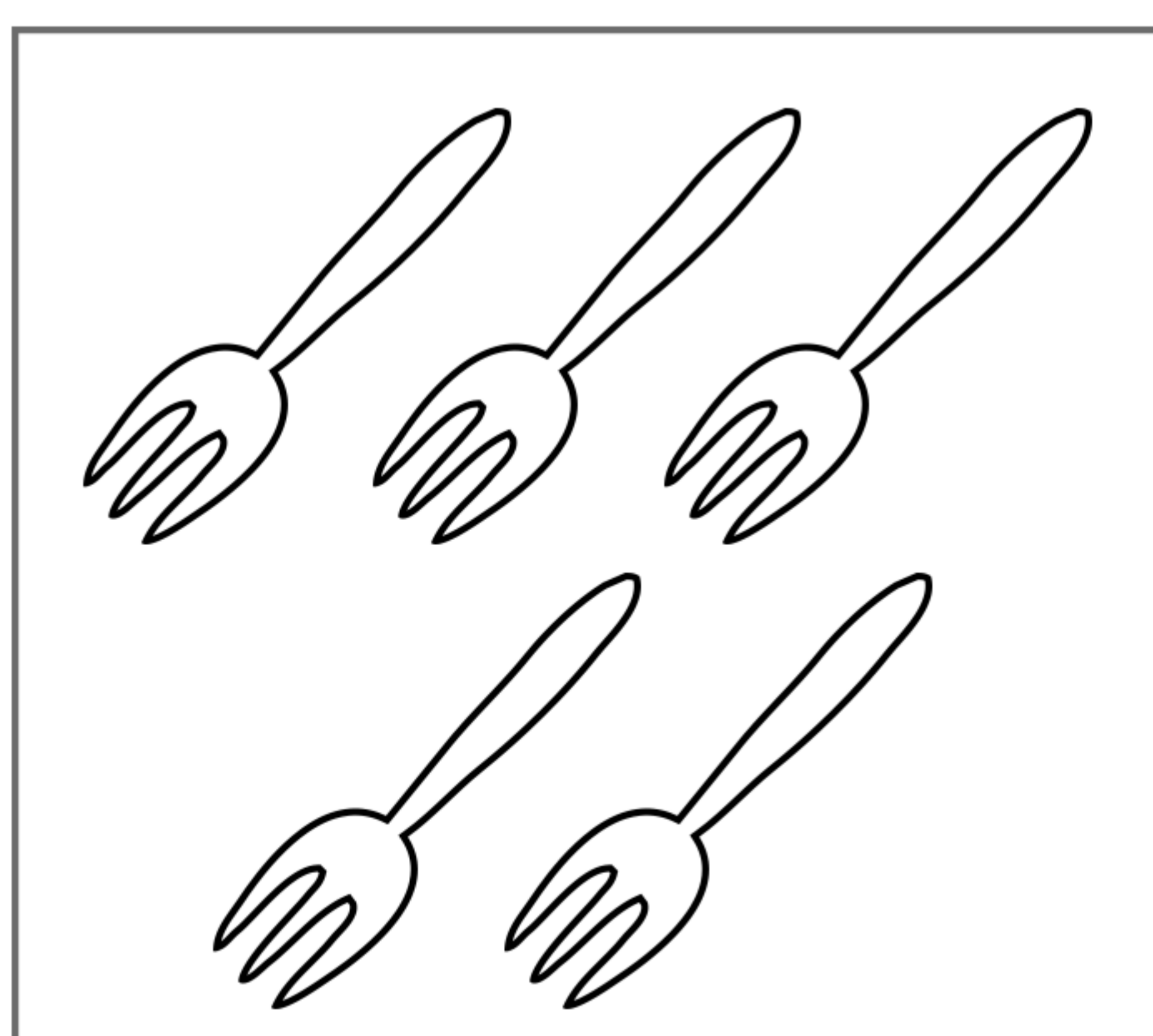
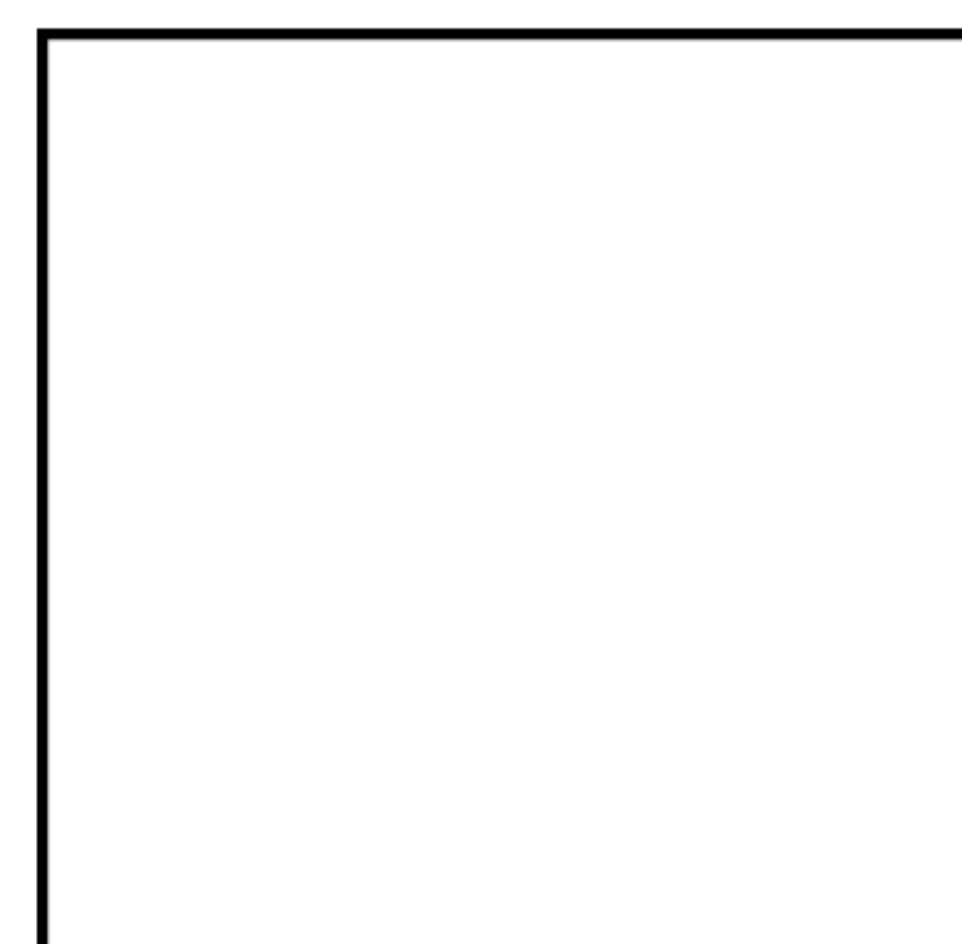

+

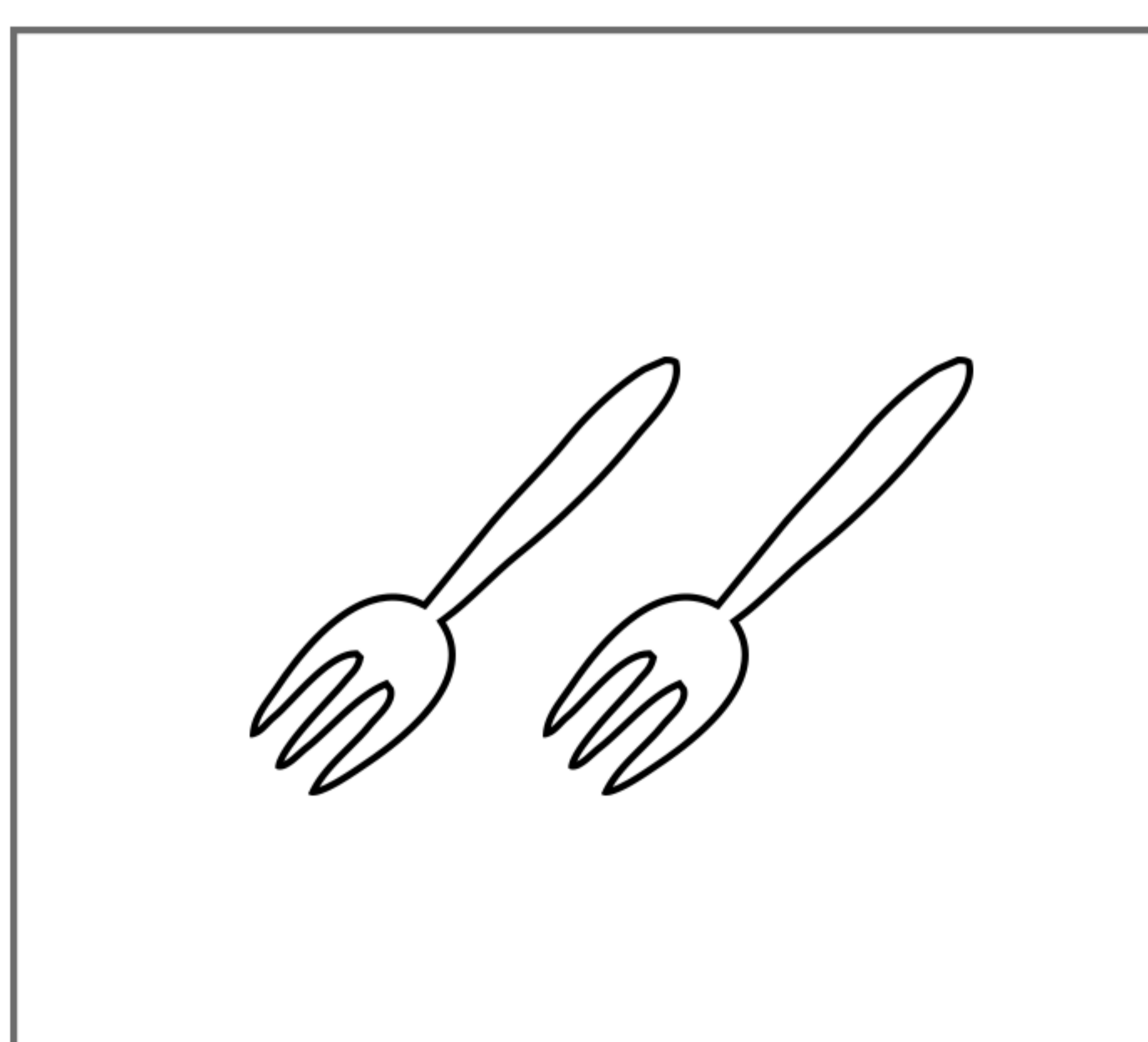

=

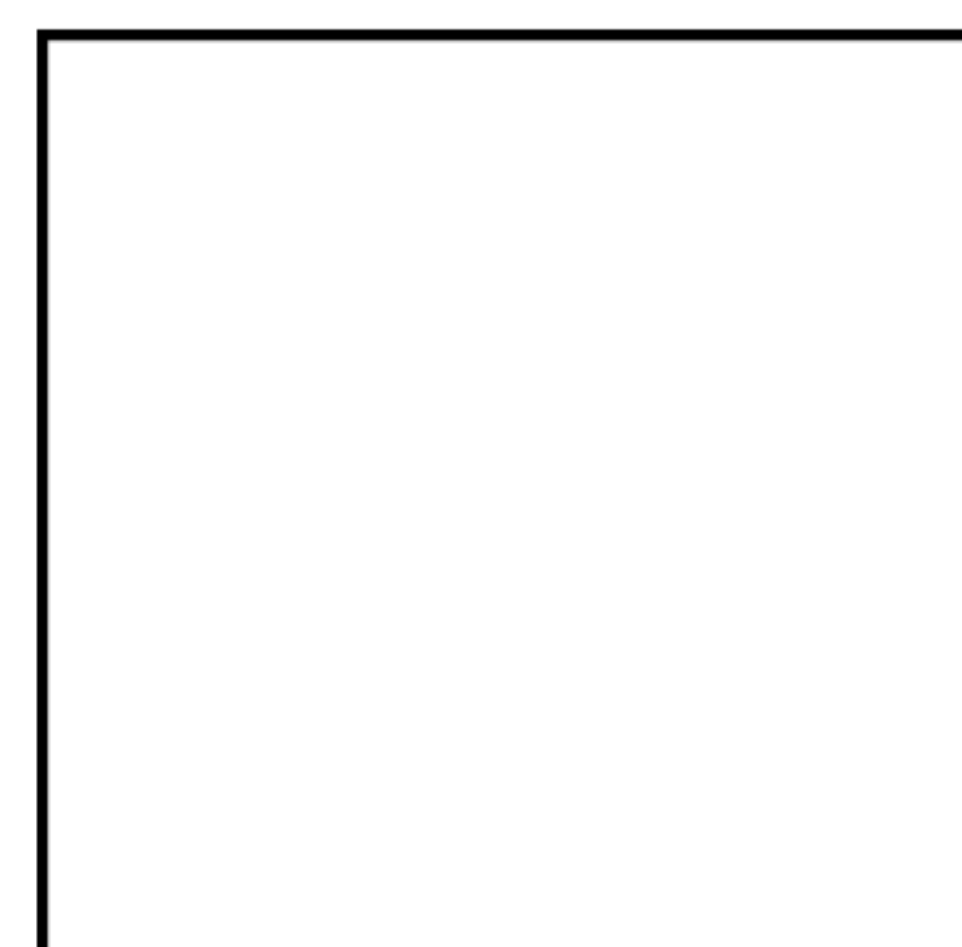

# Addizioni con i disegni

- Conta, somma e scrivi il risultato nel riquadro di destra.

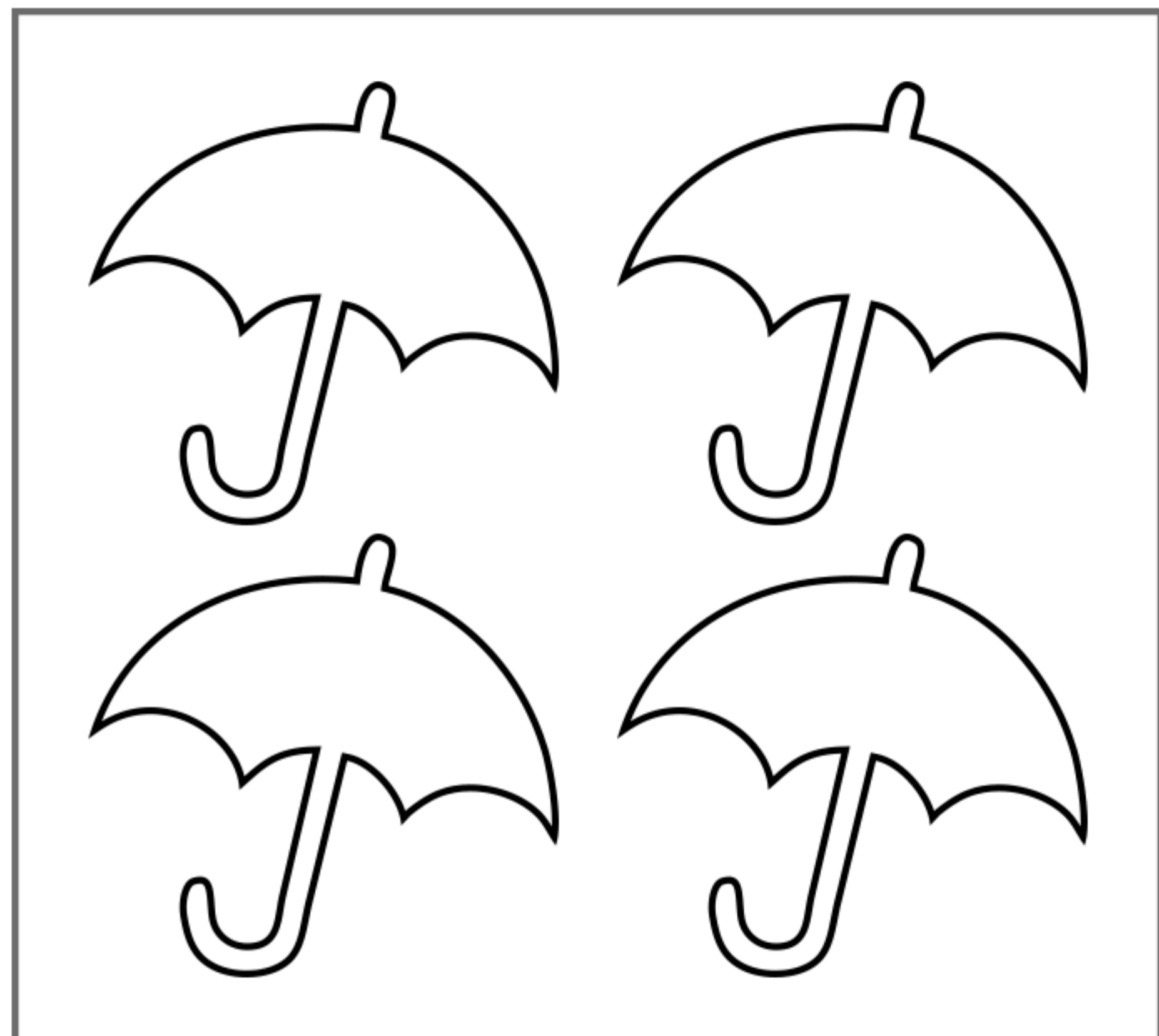

+

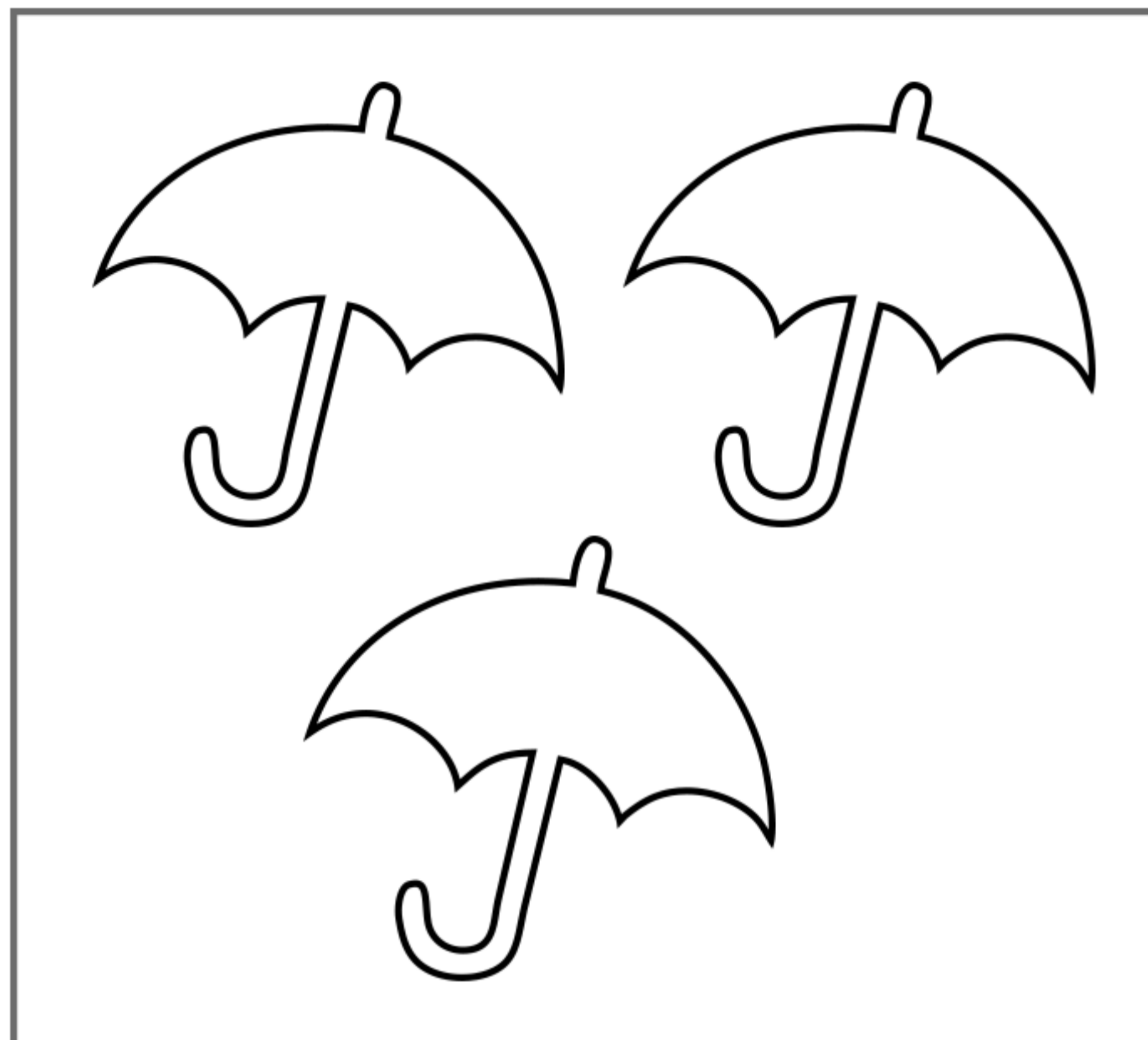

=

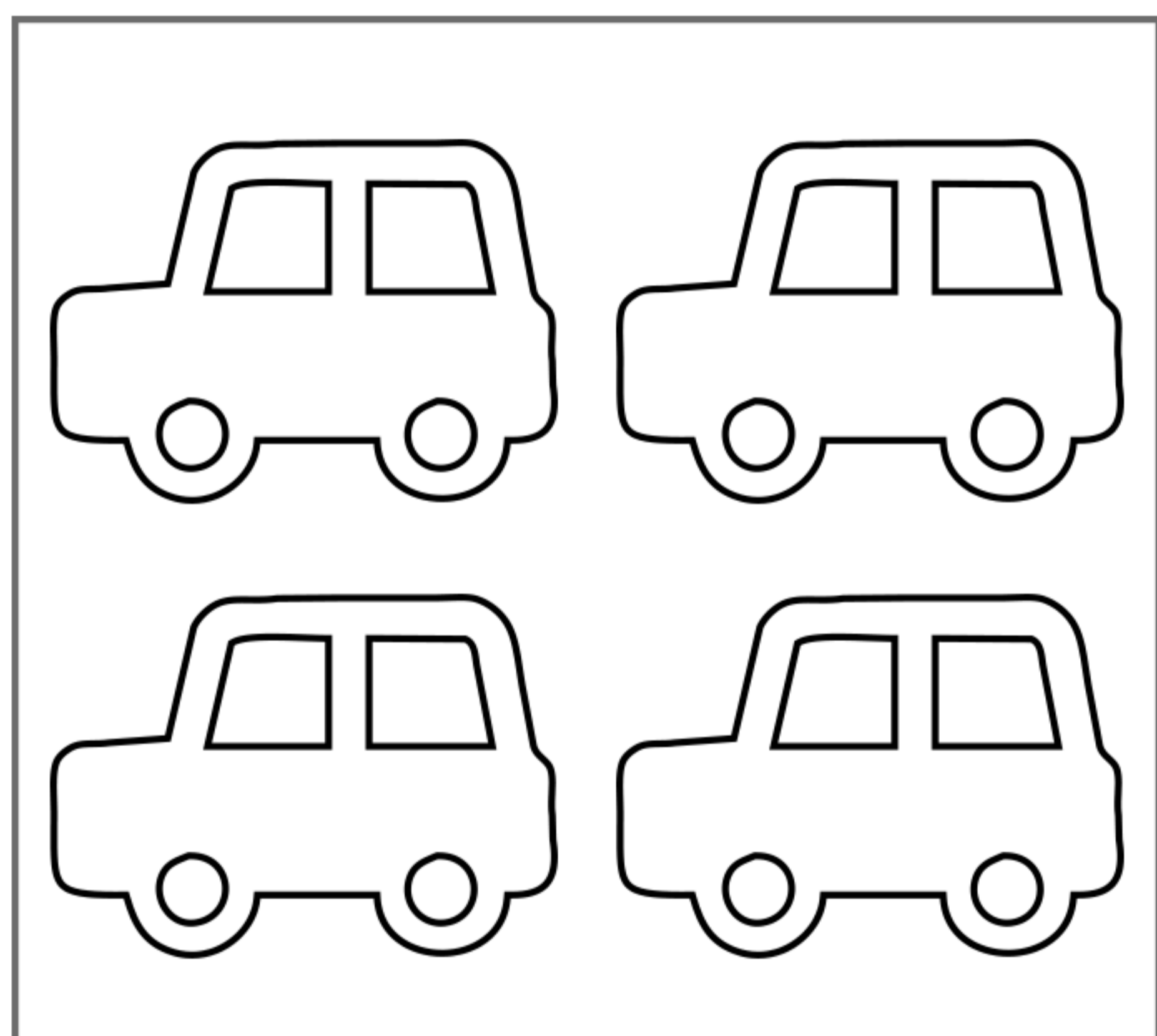
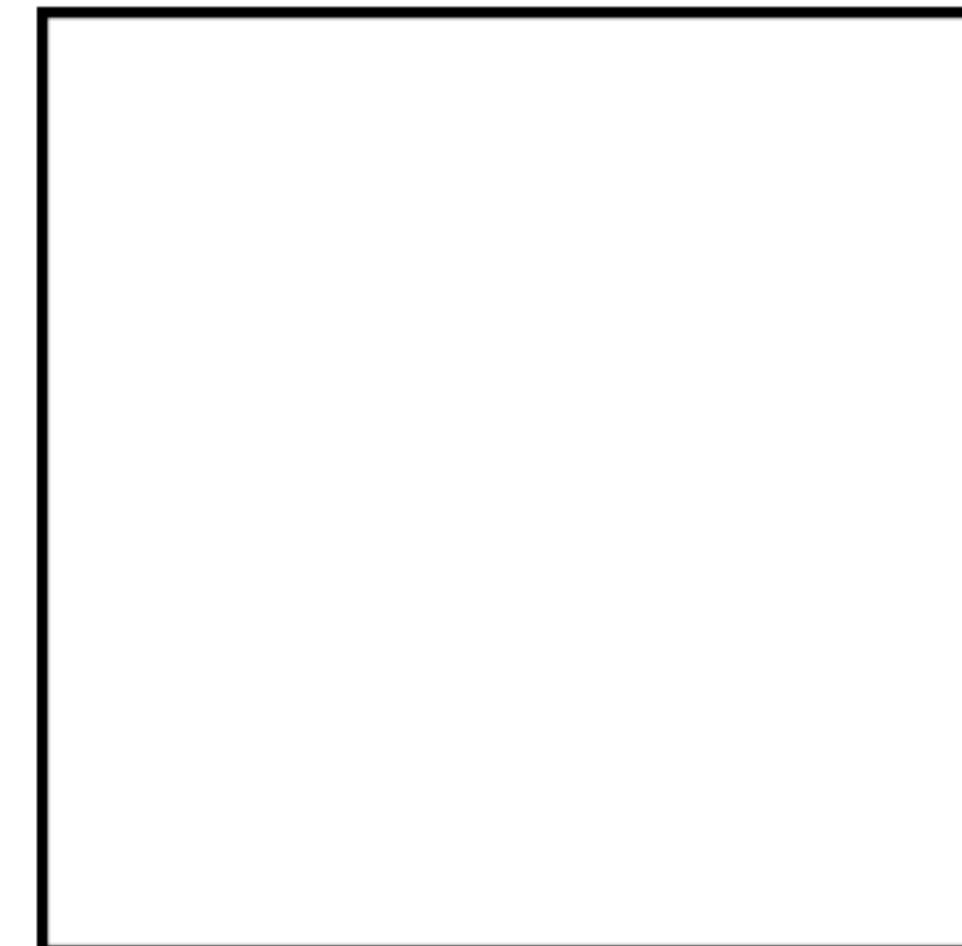

+

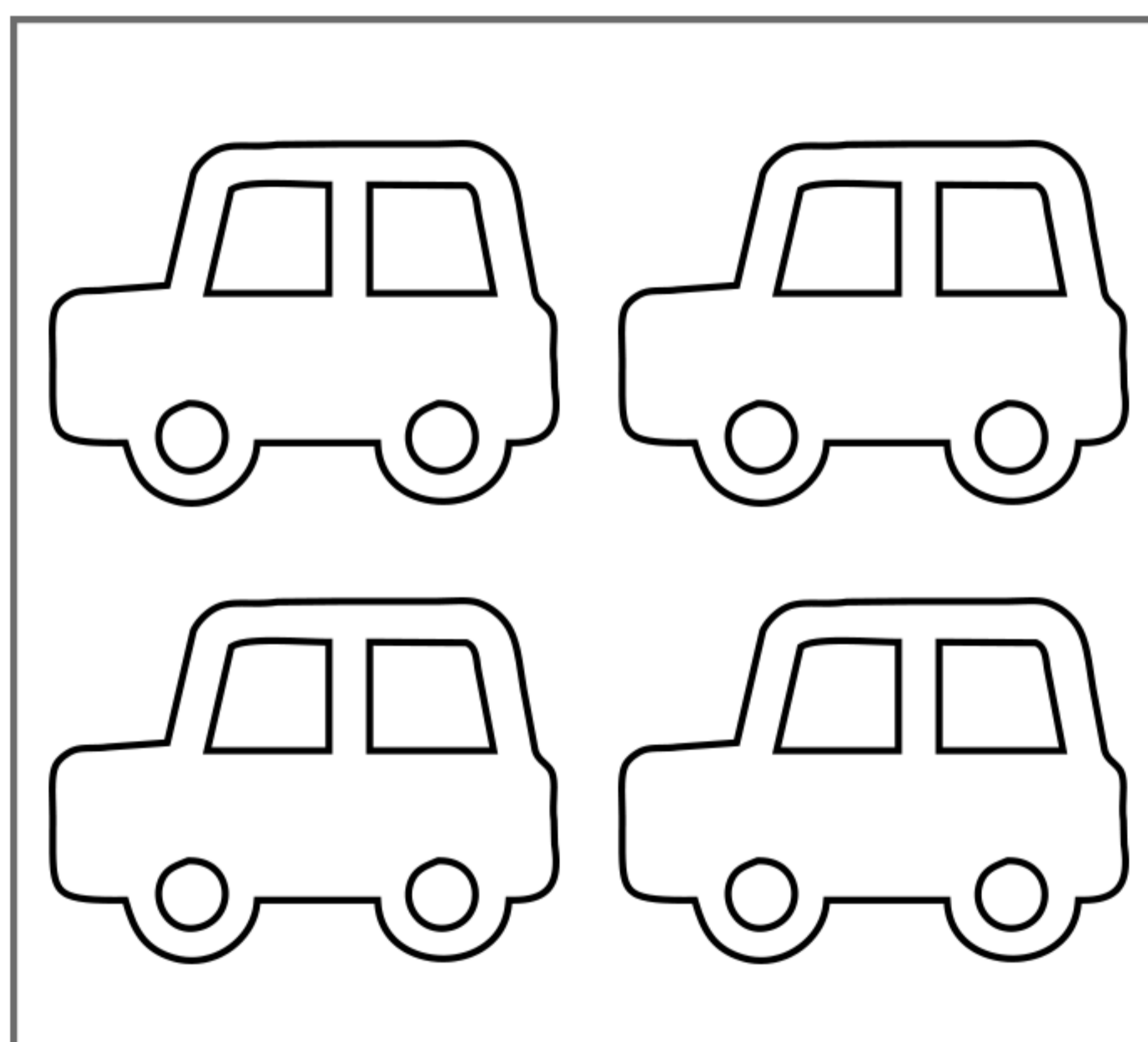

=

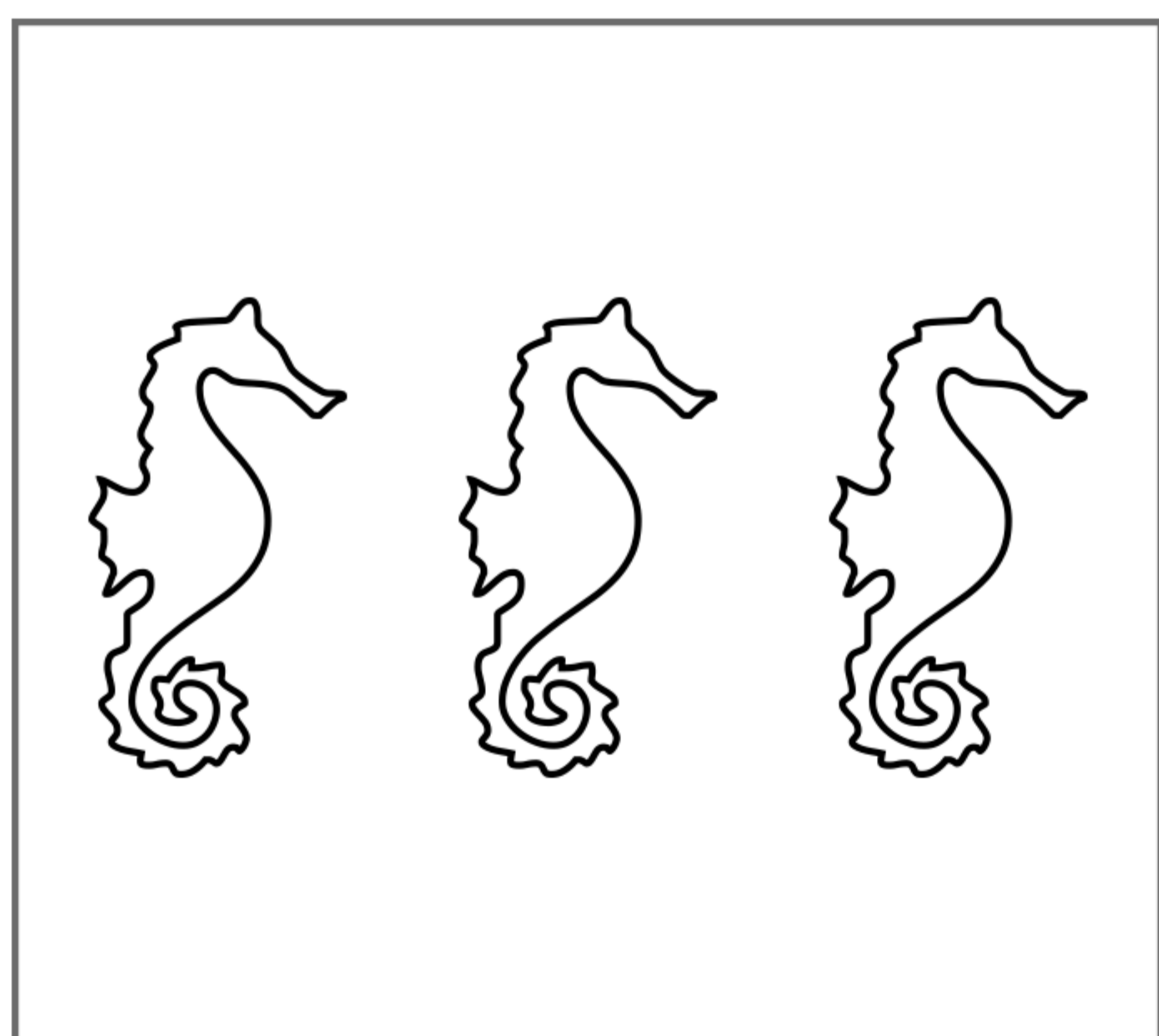
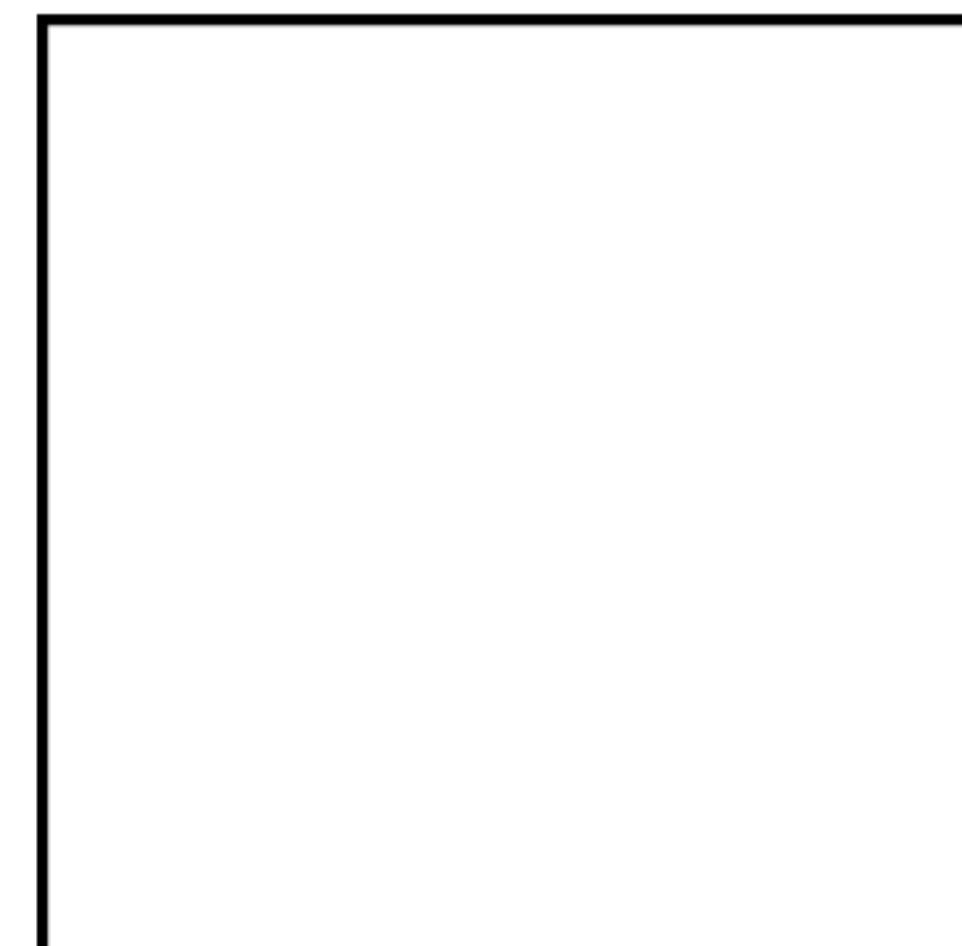

+

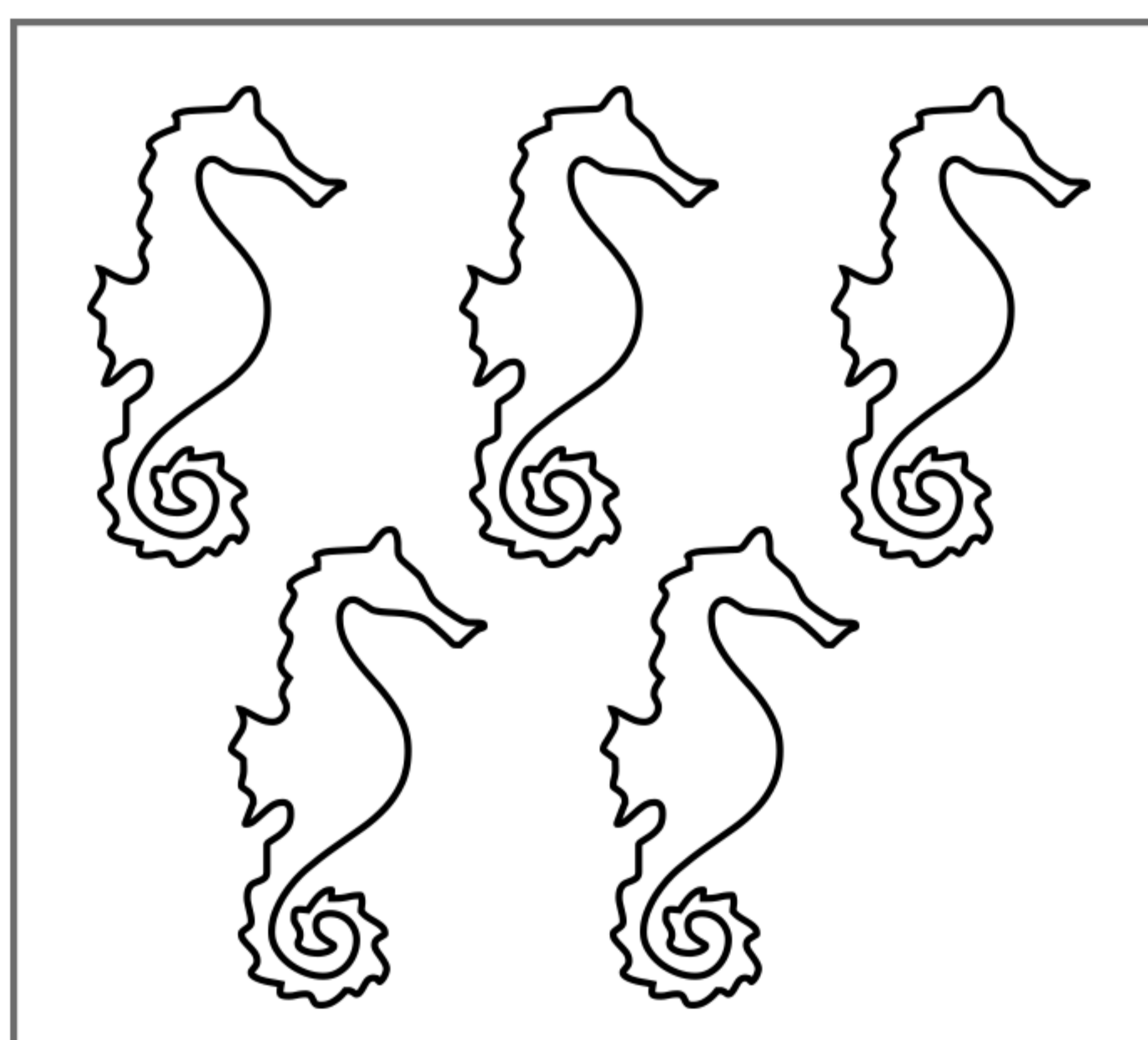

=

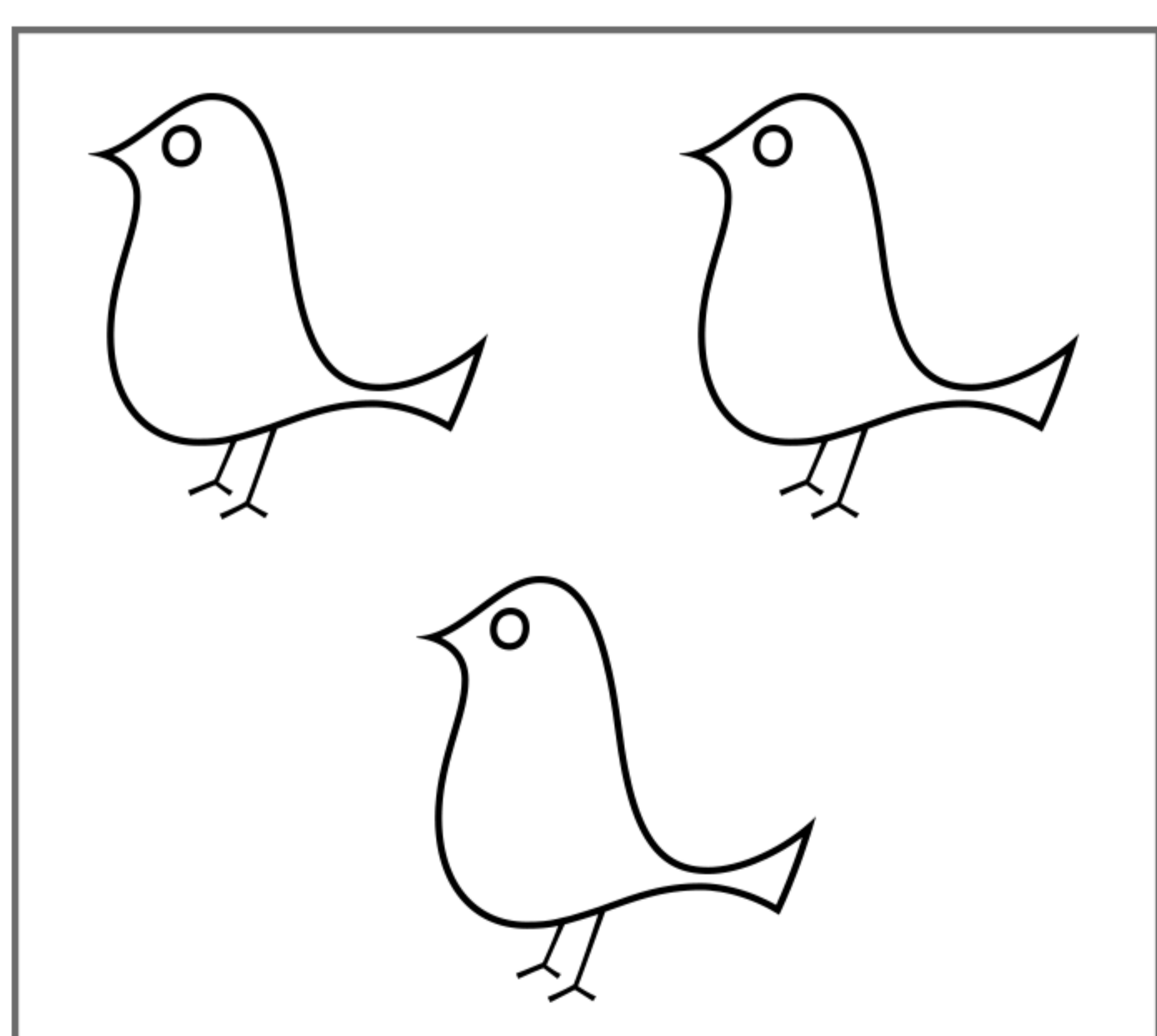
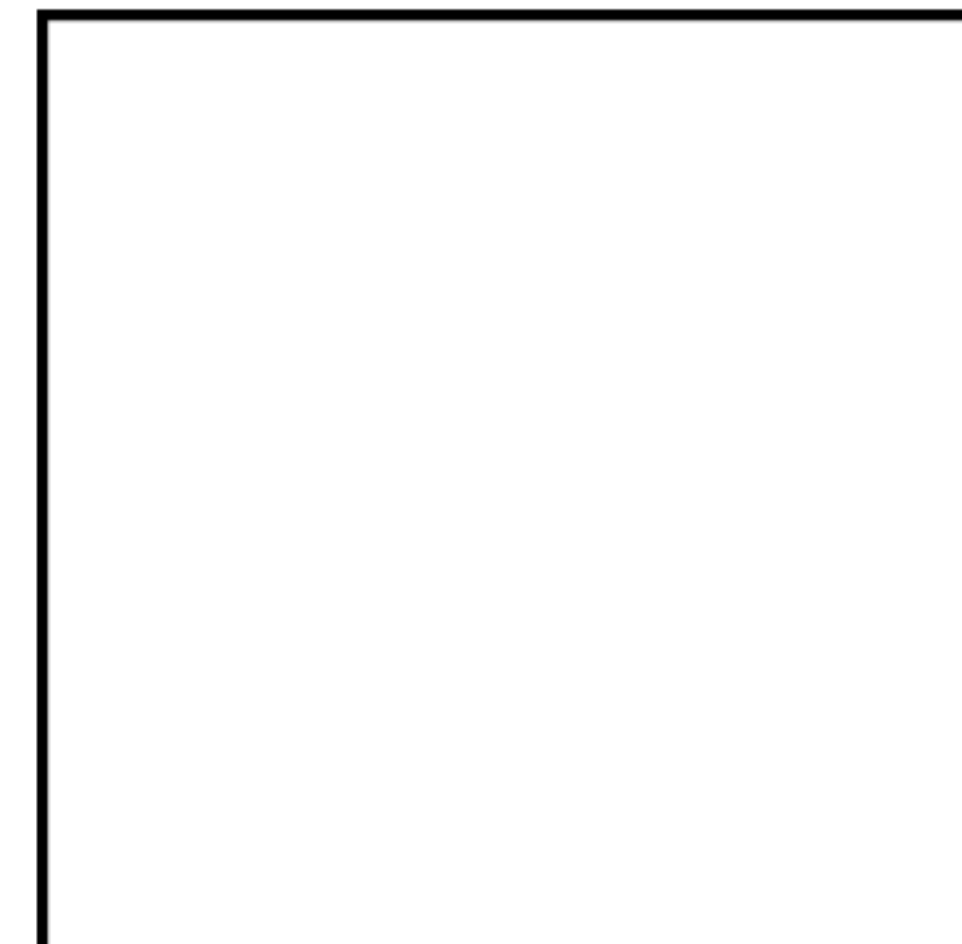

+

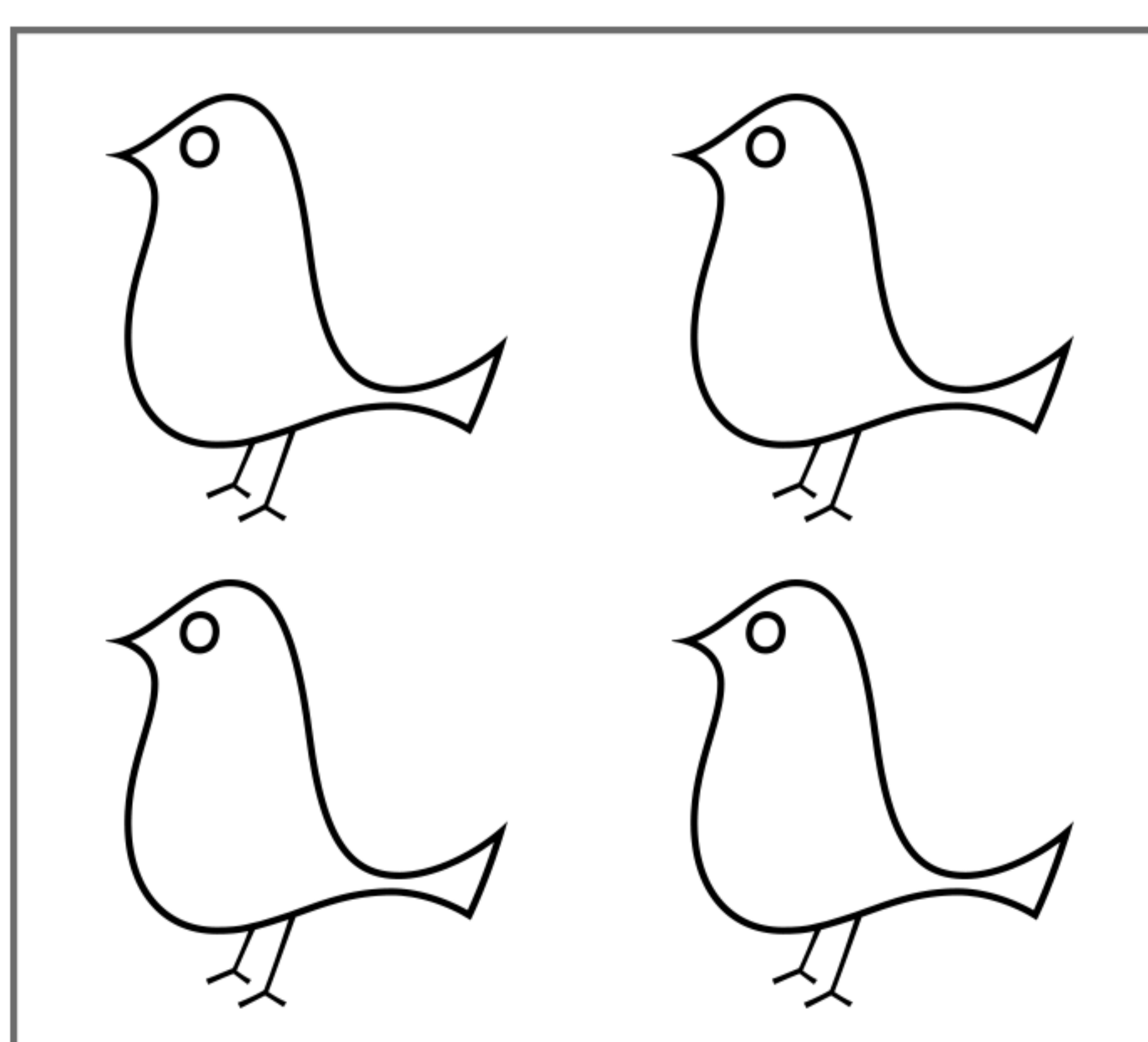

=

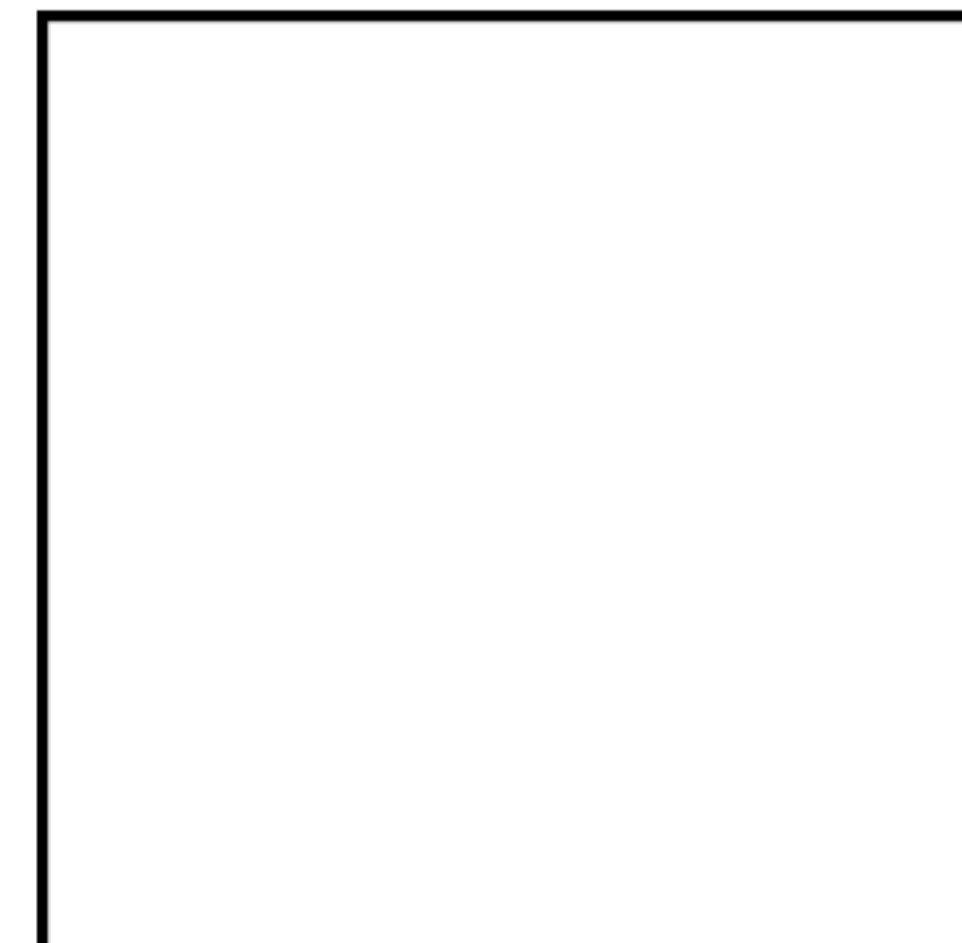

# Addizioni con i disegni

- Conta, somma e scrivi il risultato nel riquadro di destra.

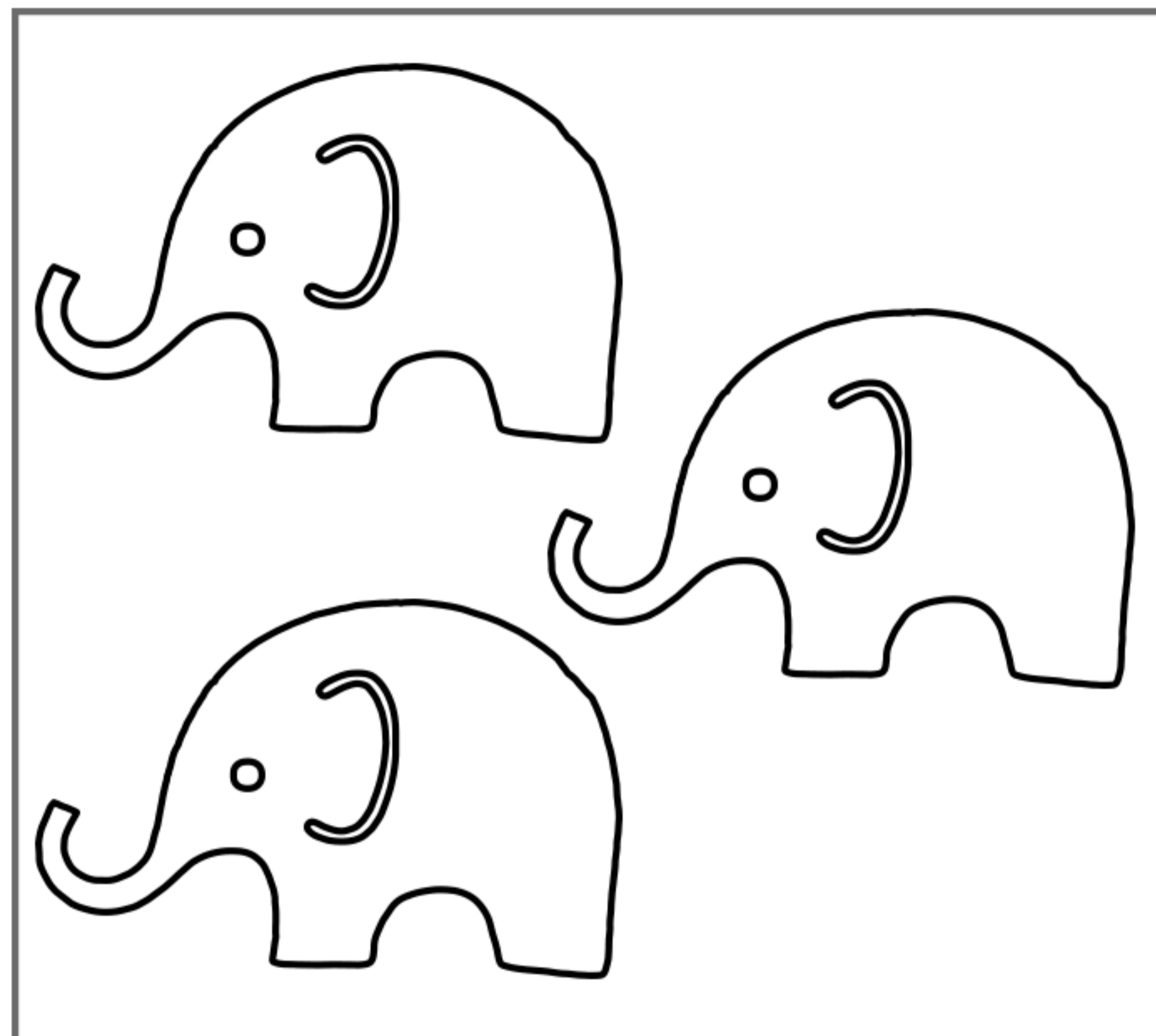

+

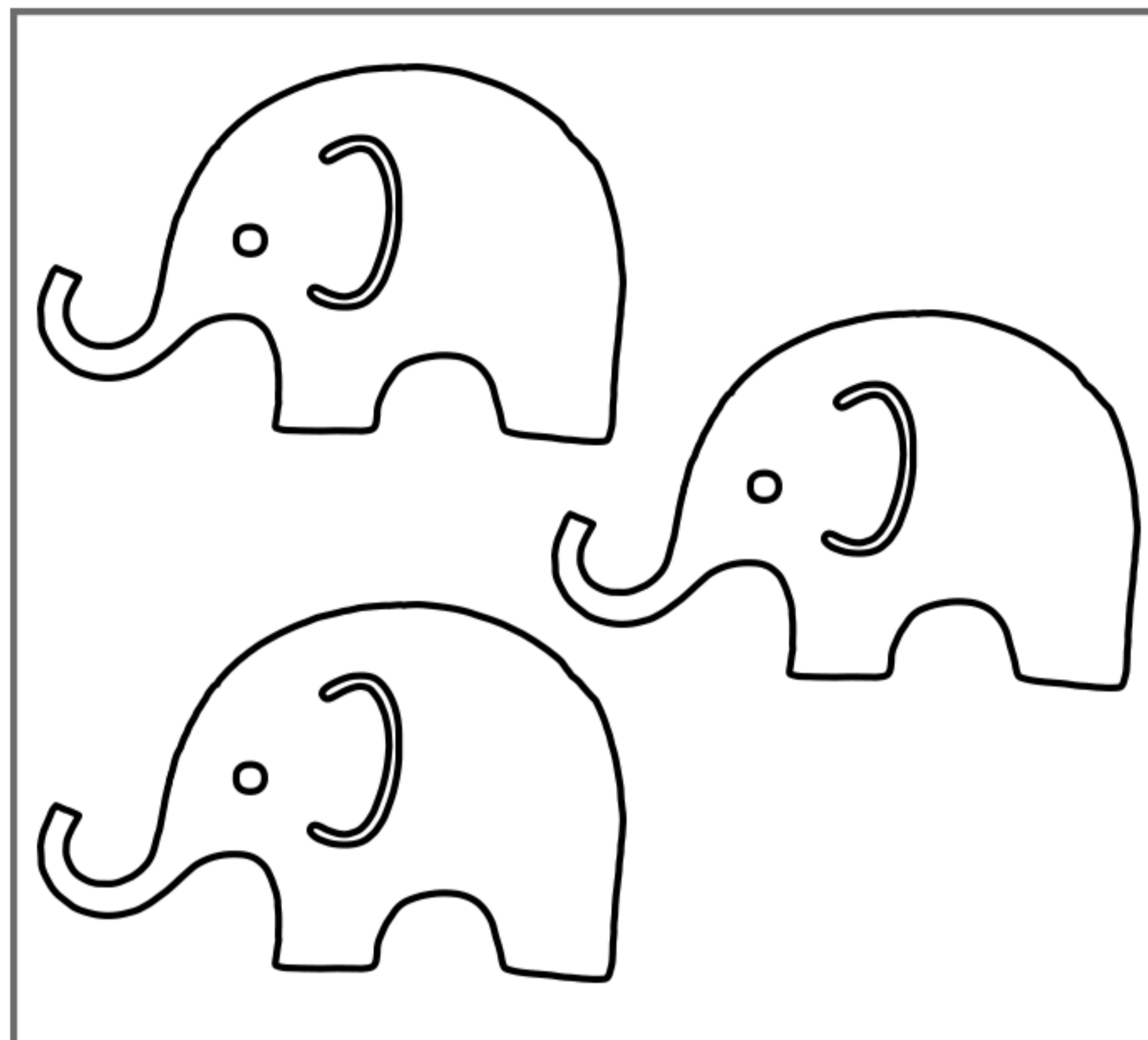

=

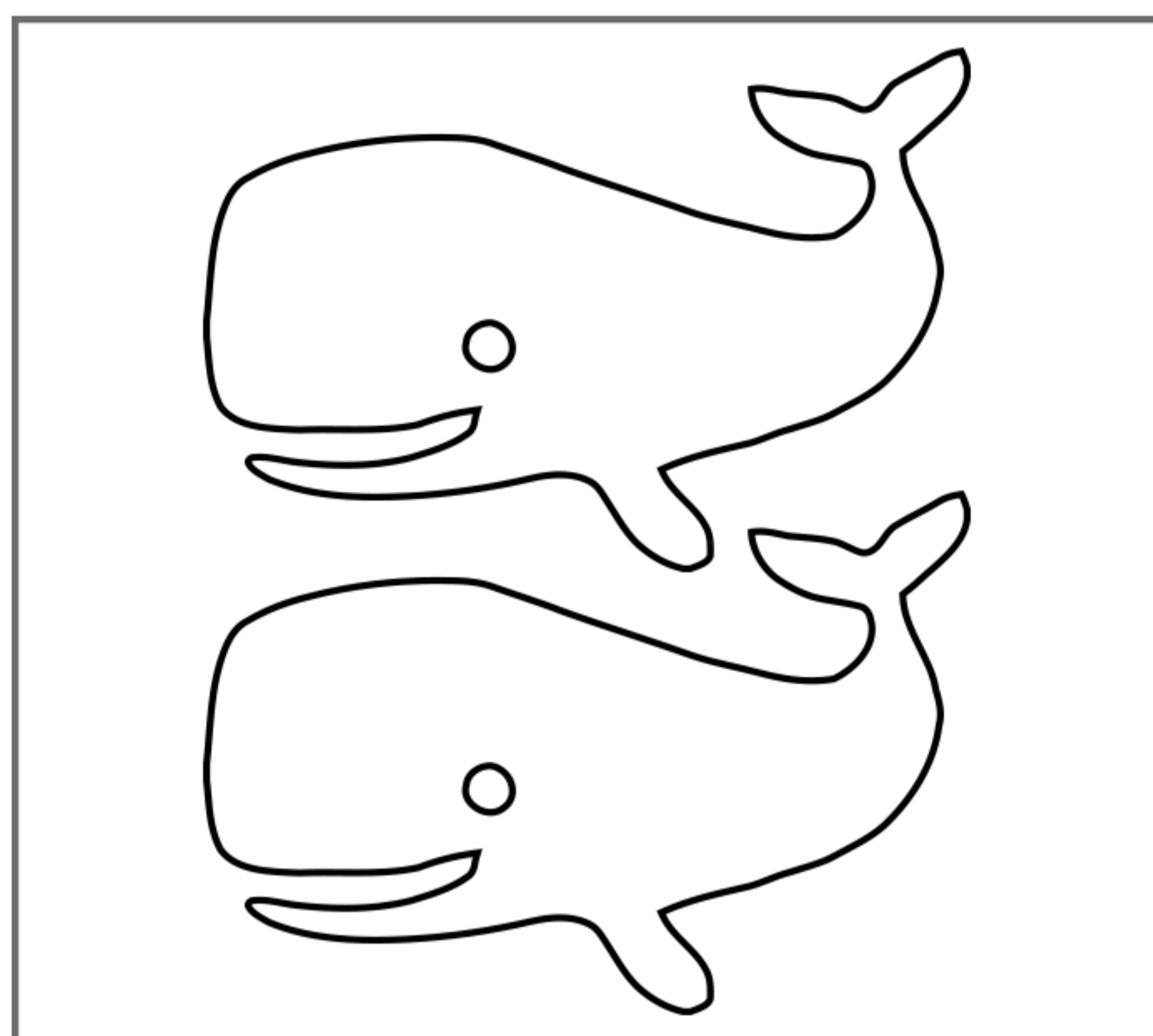
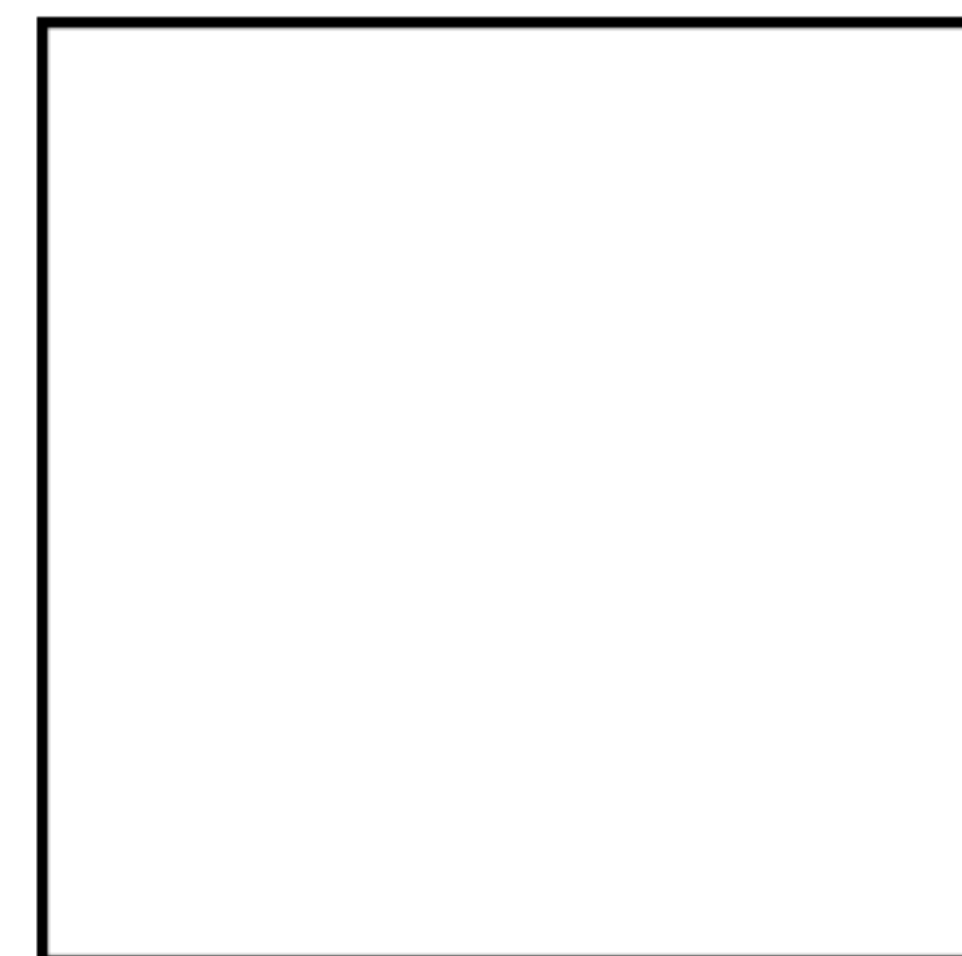

+

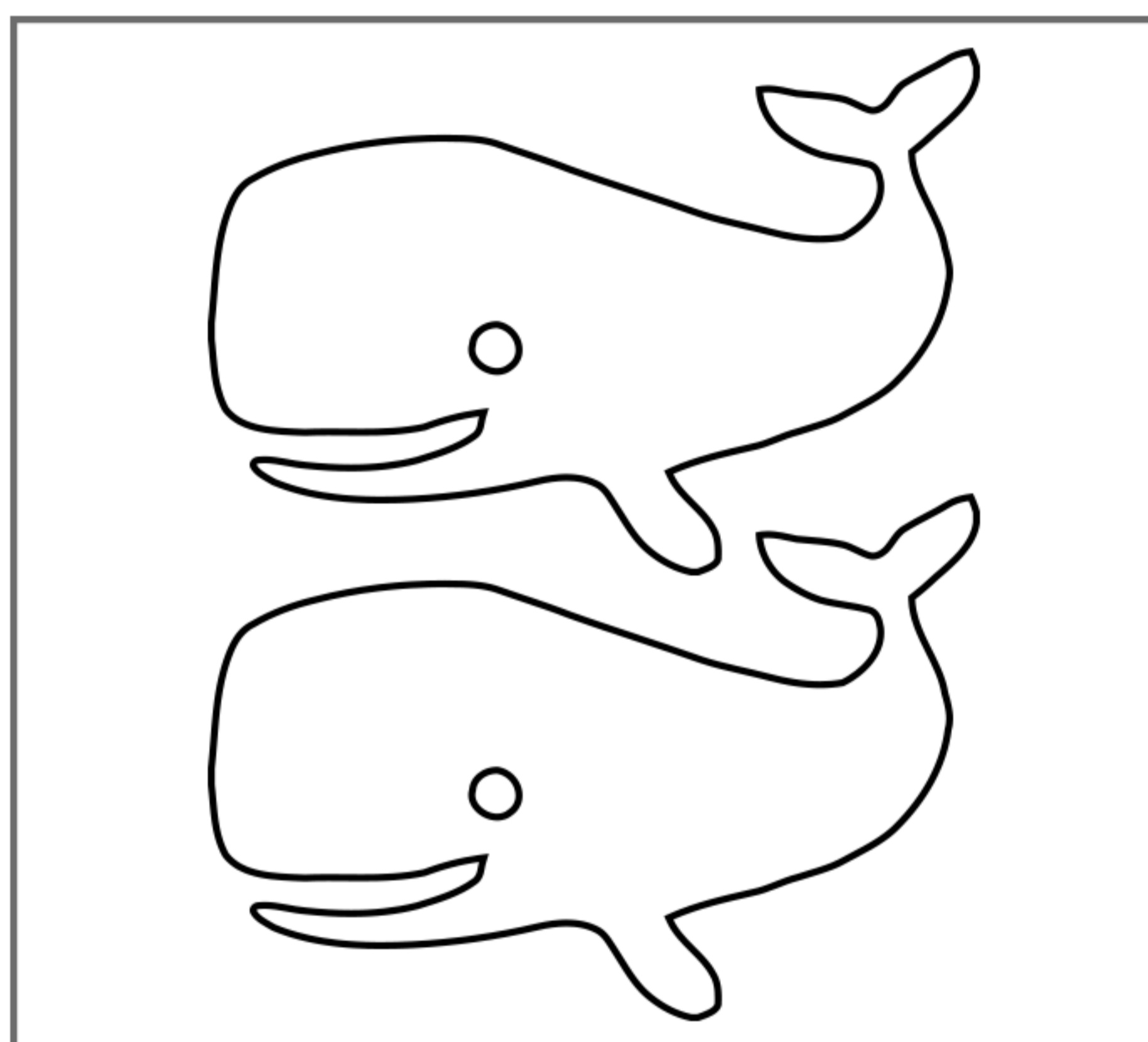

=

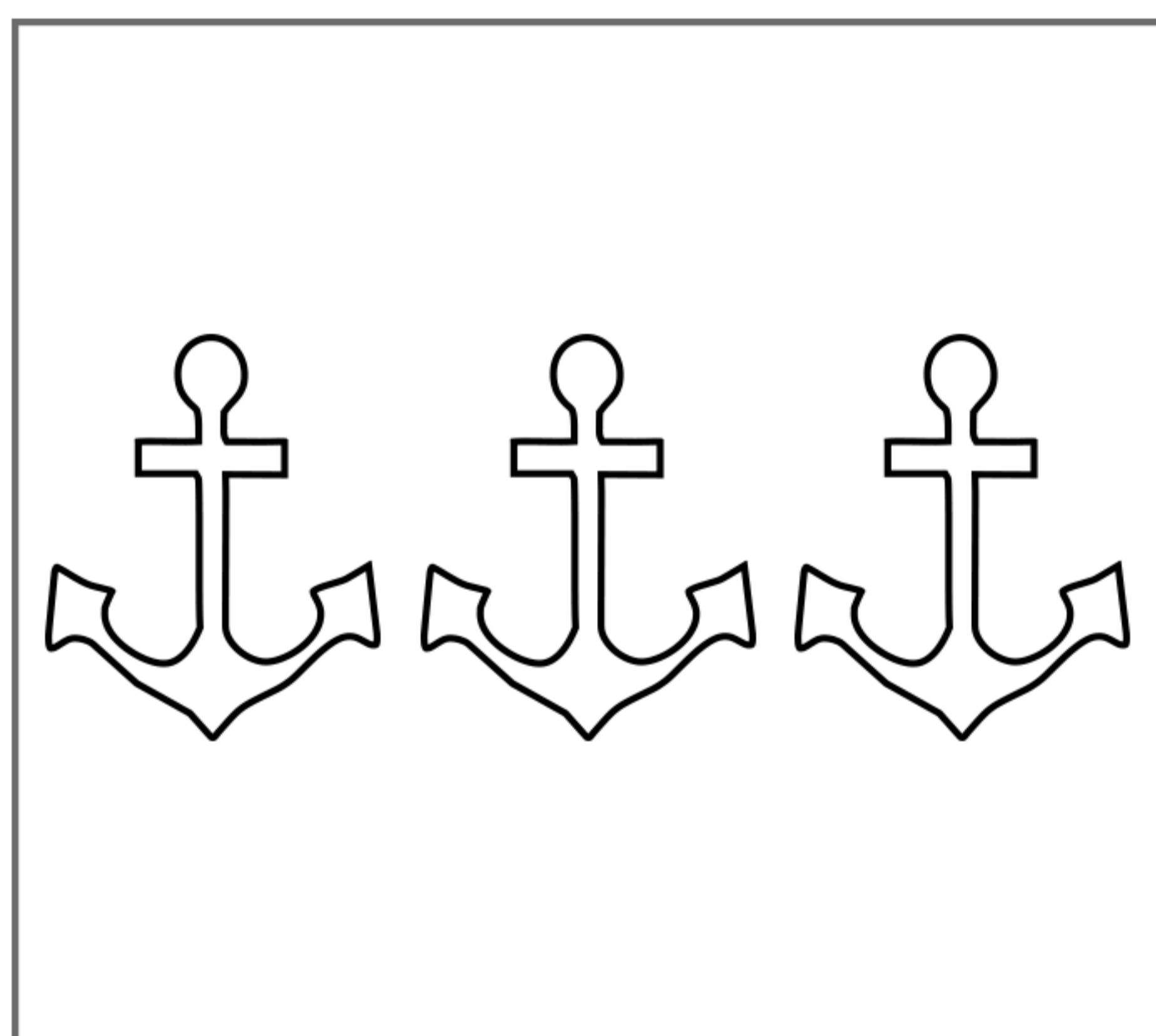
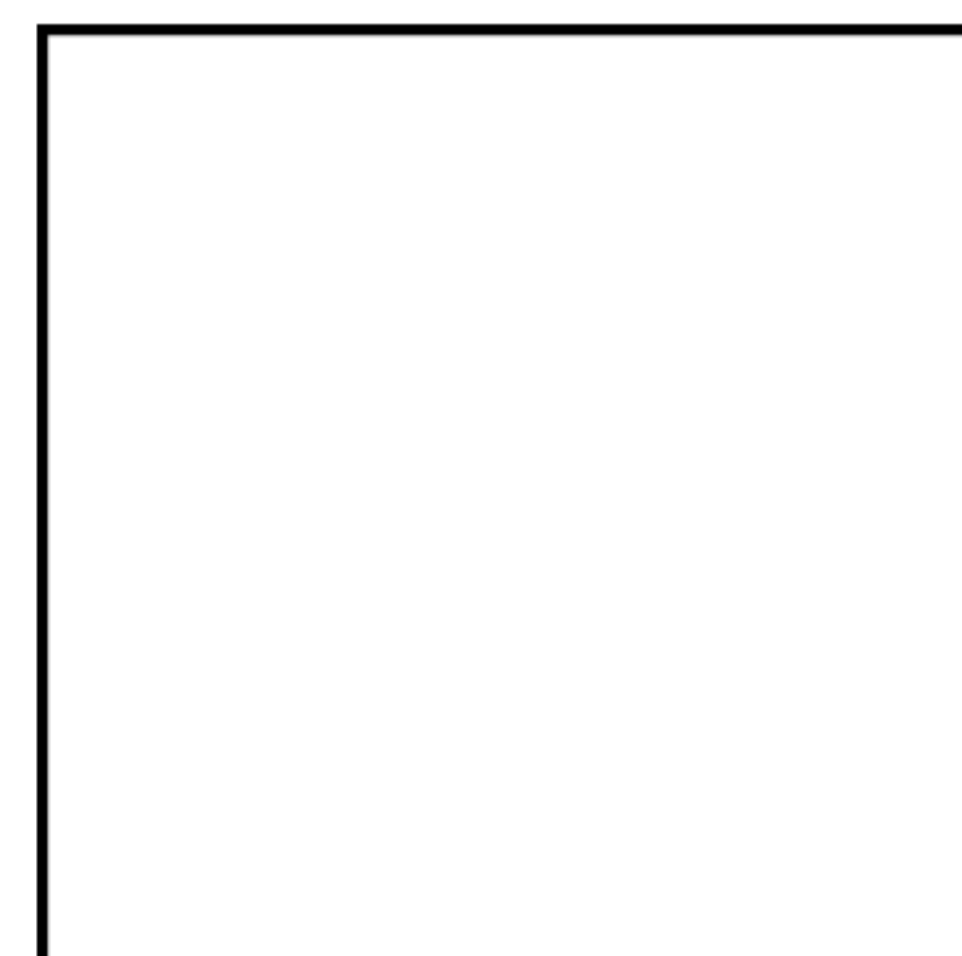

+

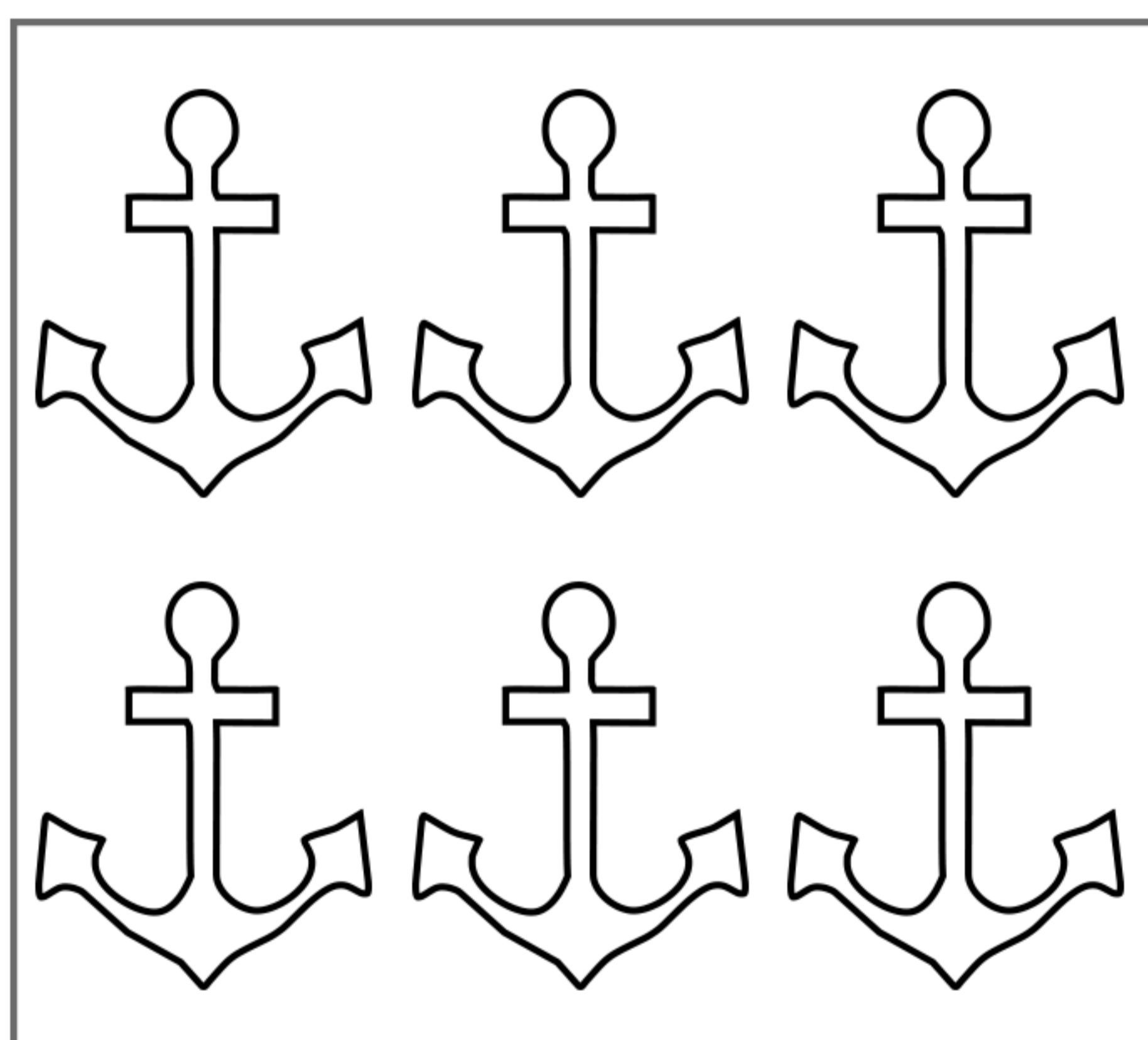

=

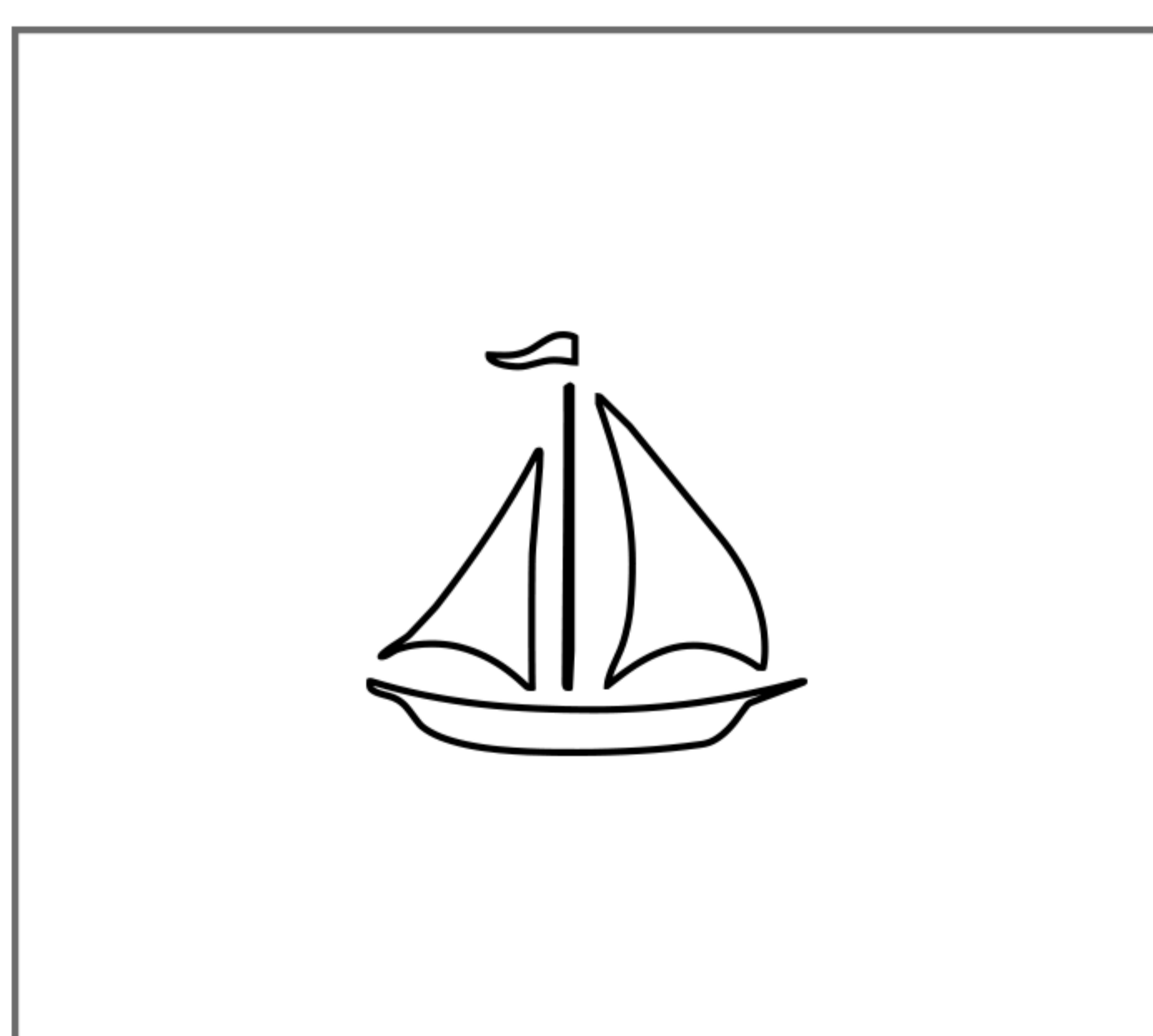
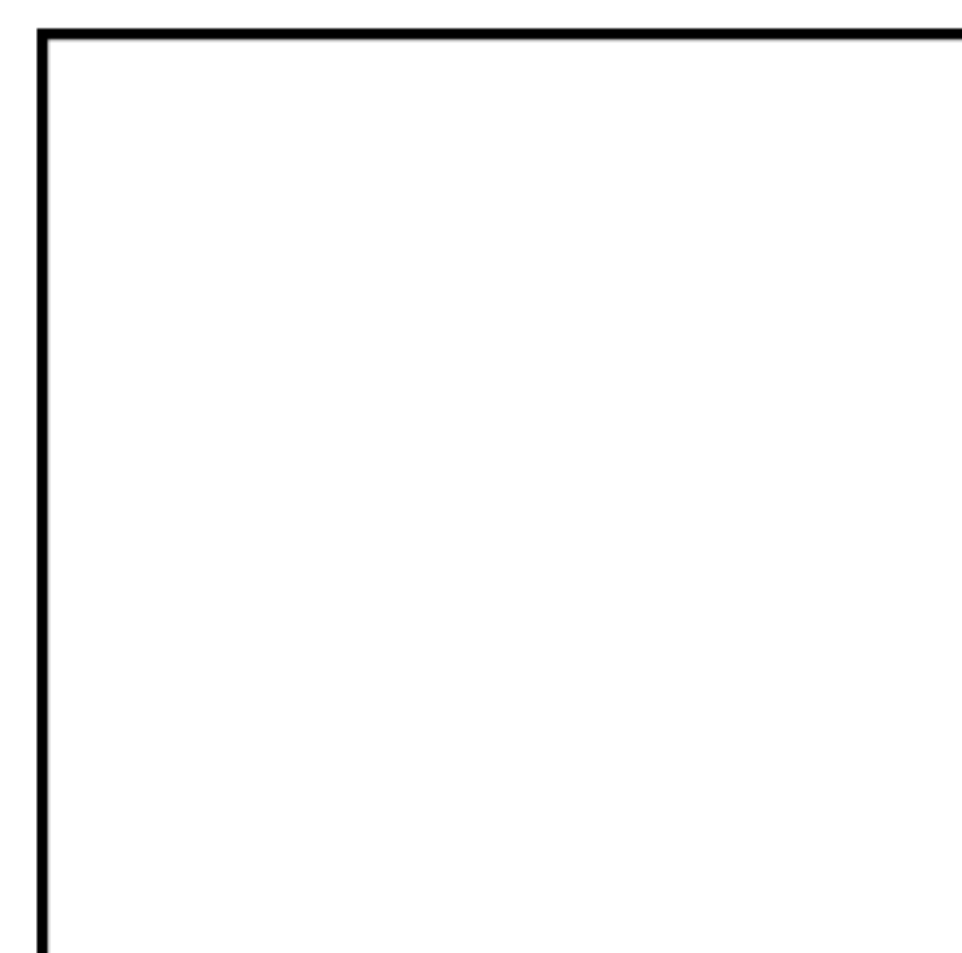

+

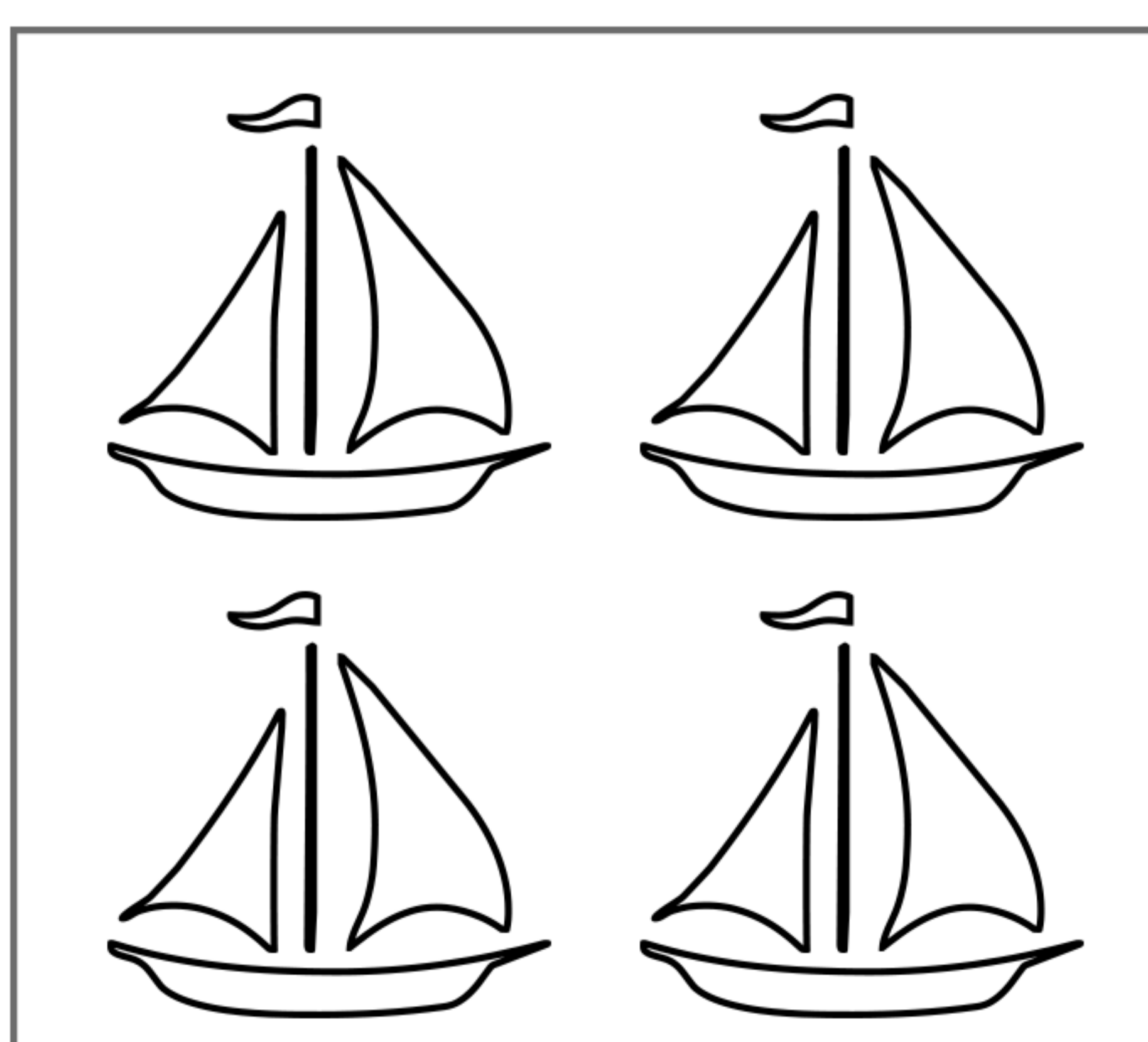

=



# Addizioni con i disegni

- Conta, somma e scrivi il risultato nel riquadro di destra.

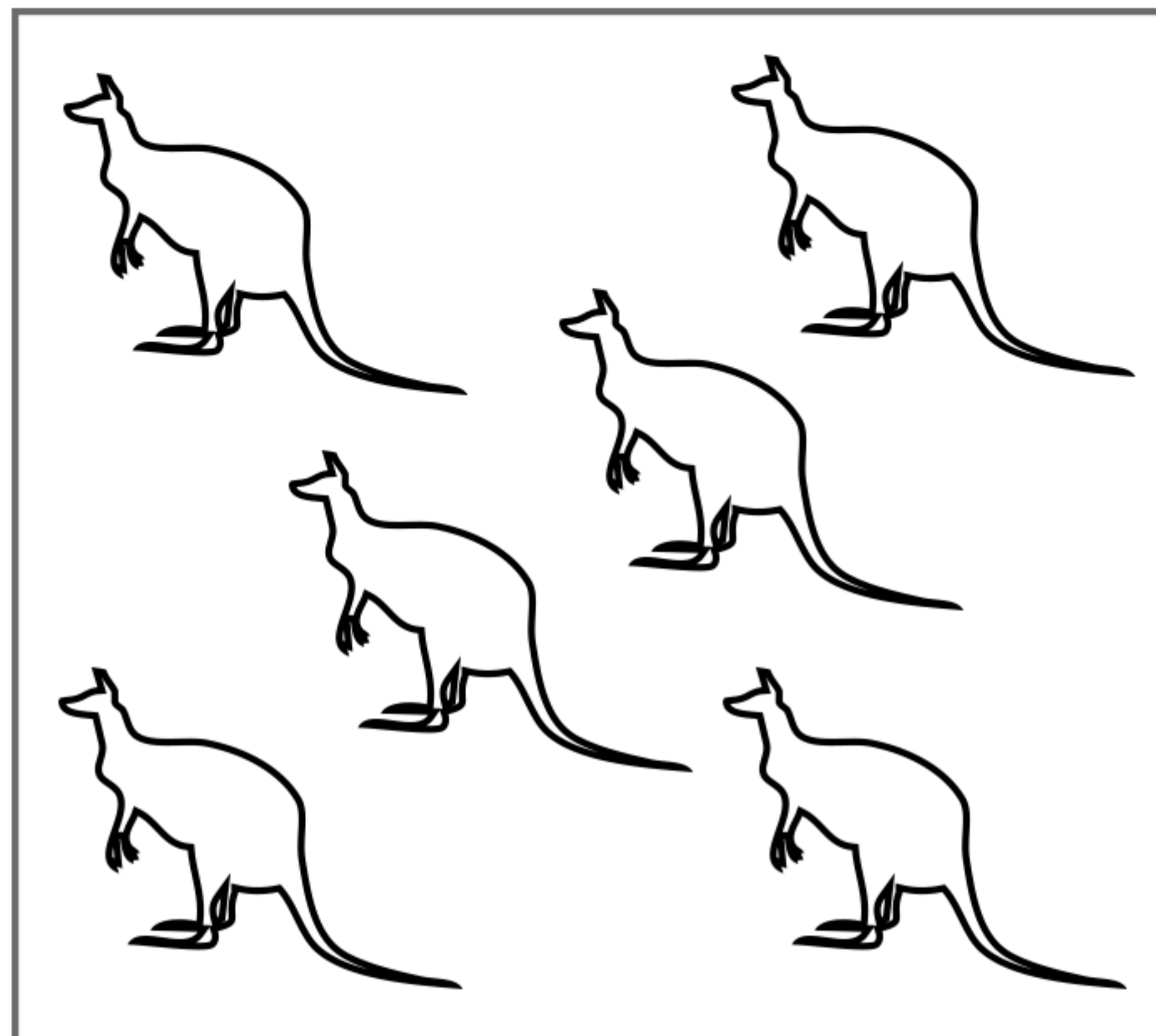

+

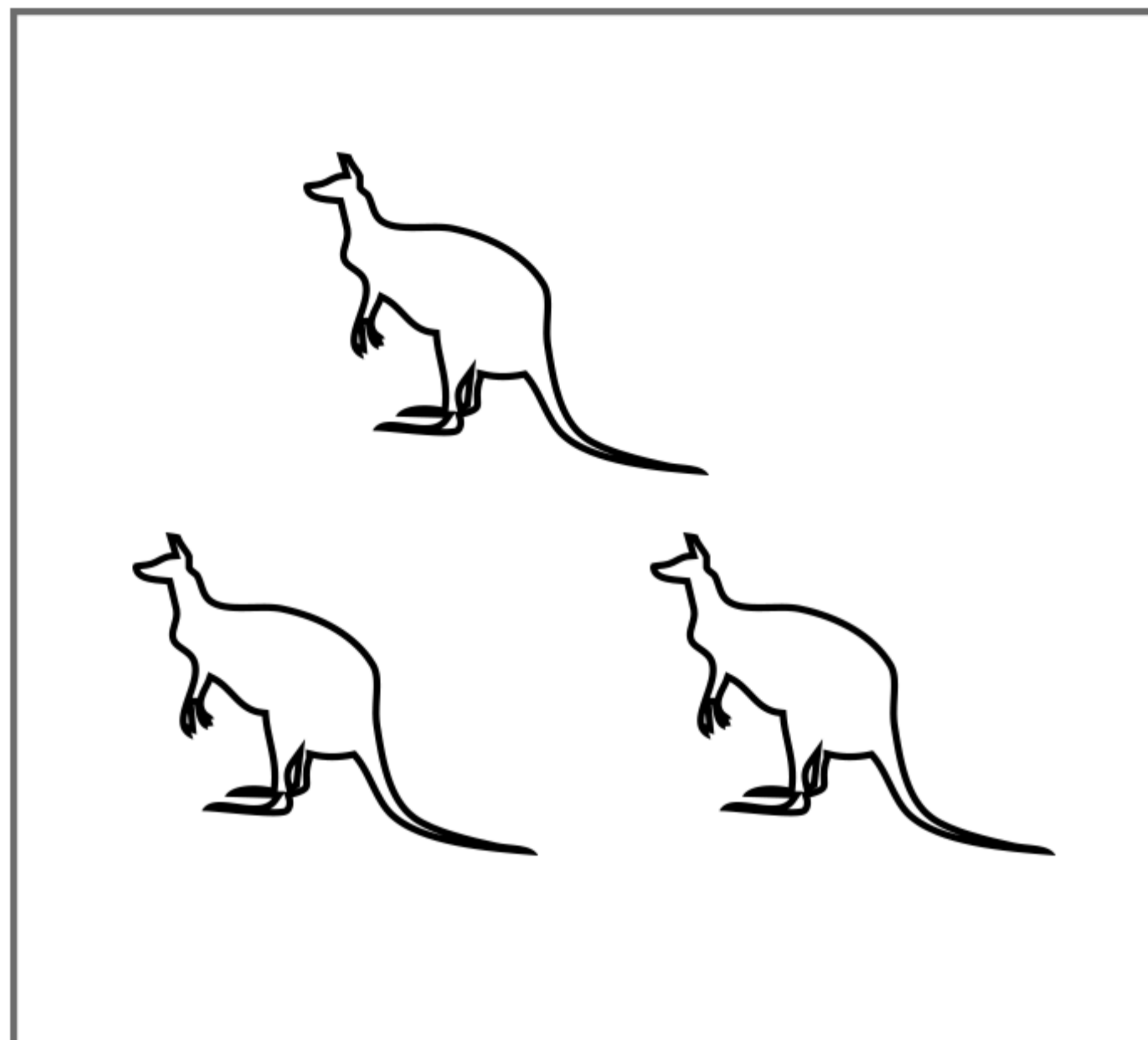

=

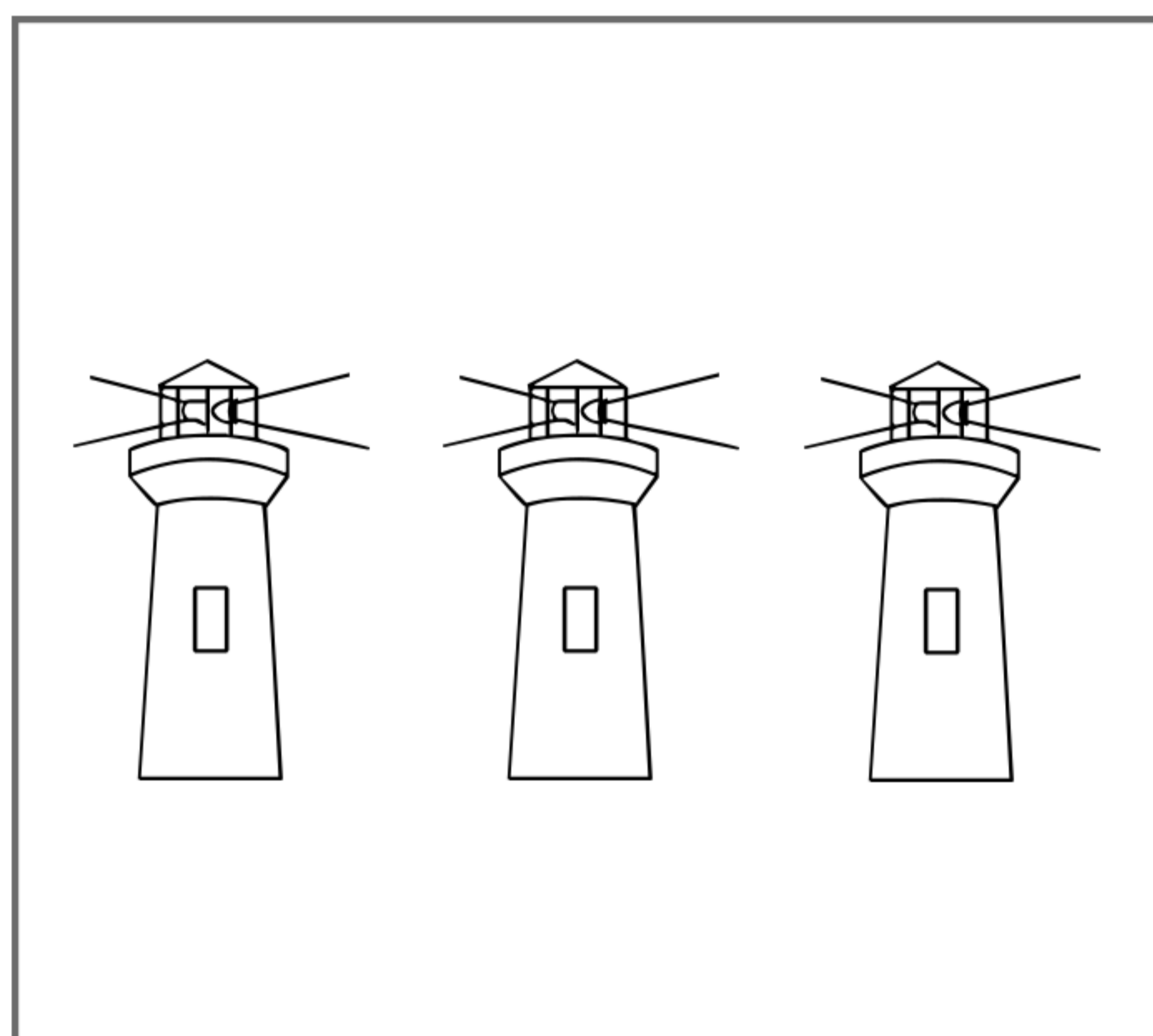
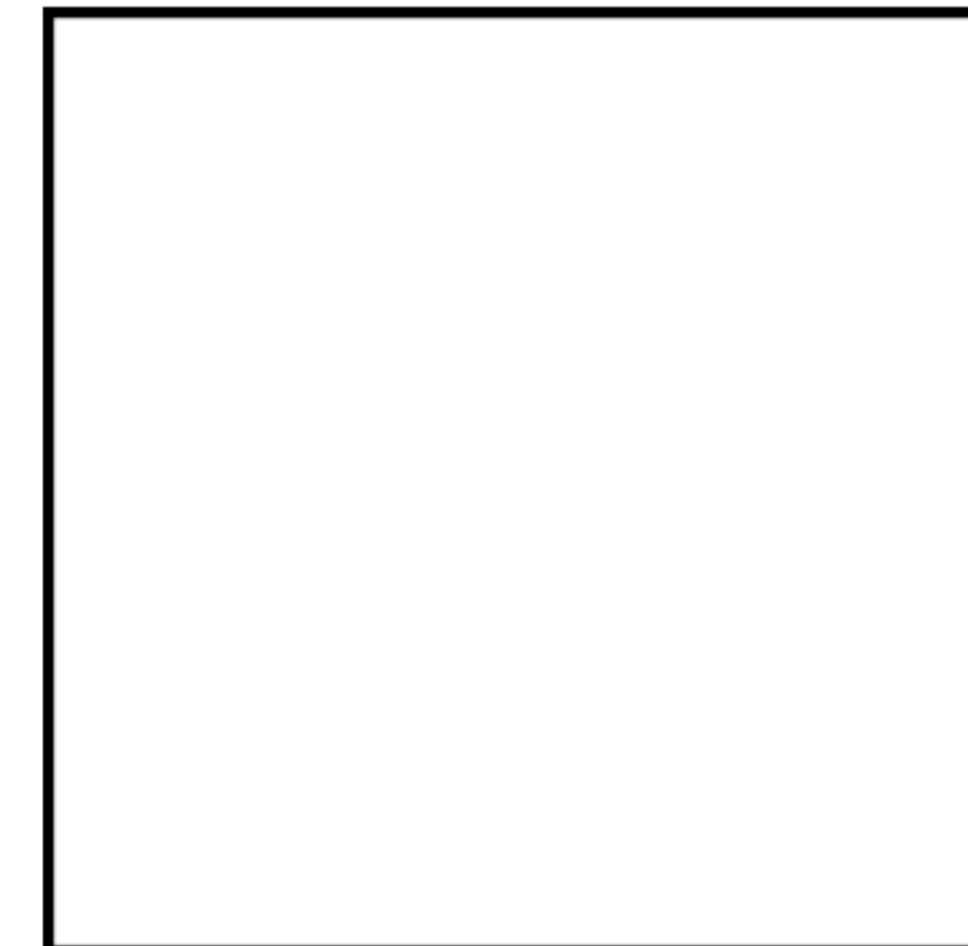

+

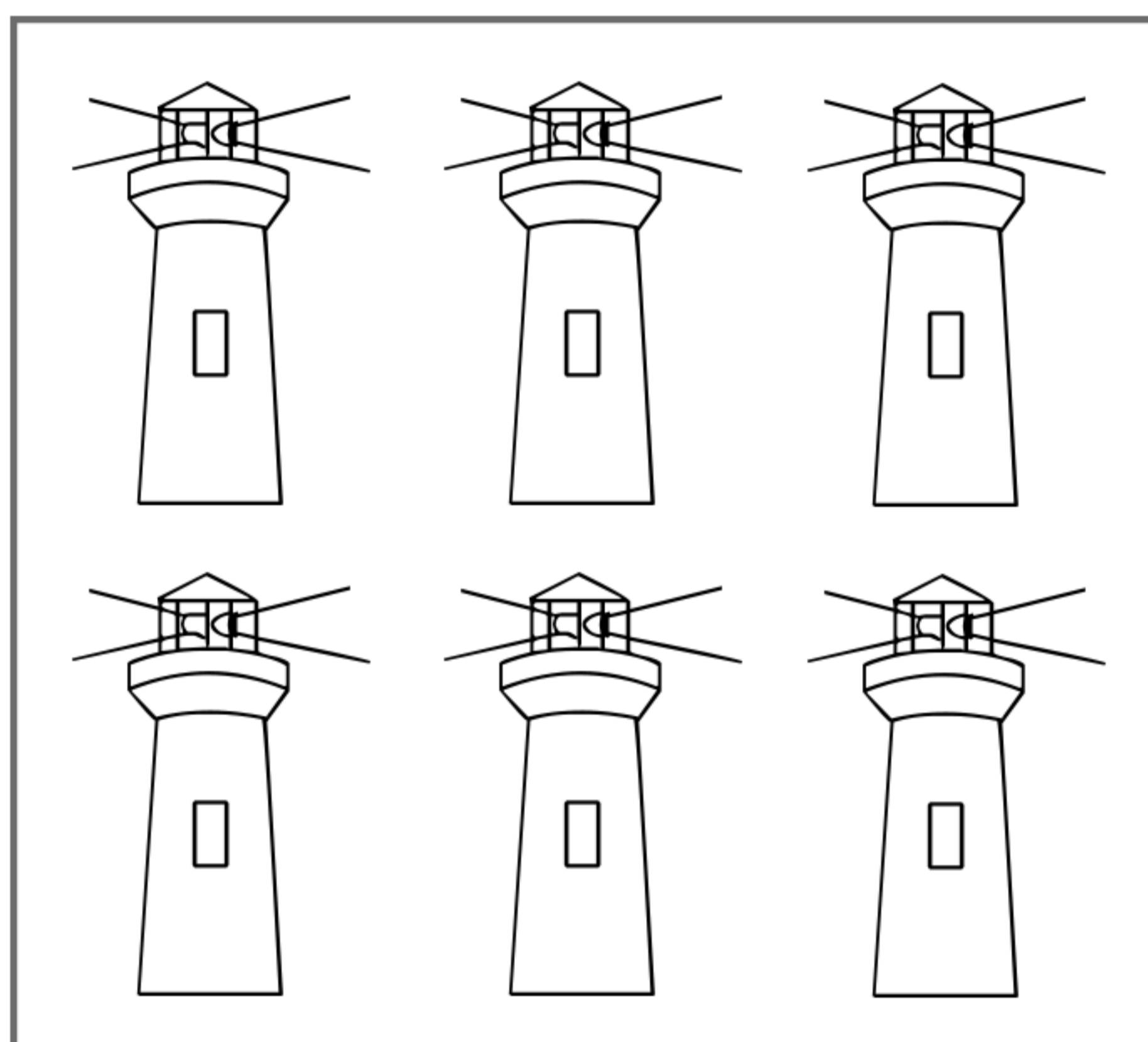

=

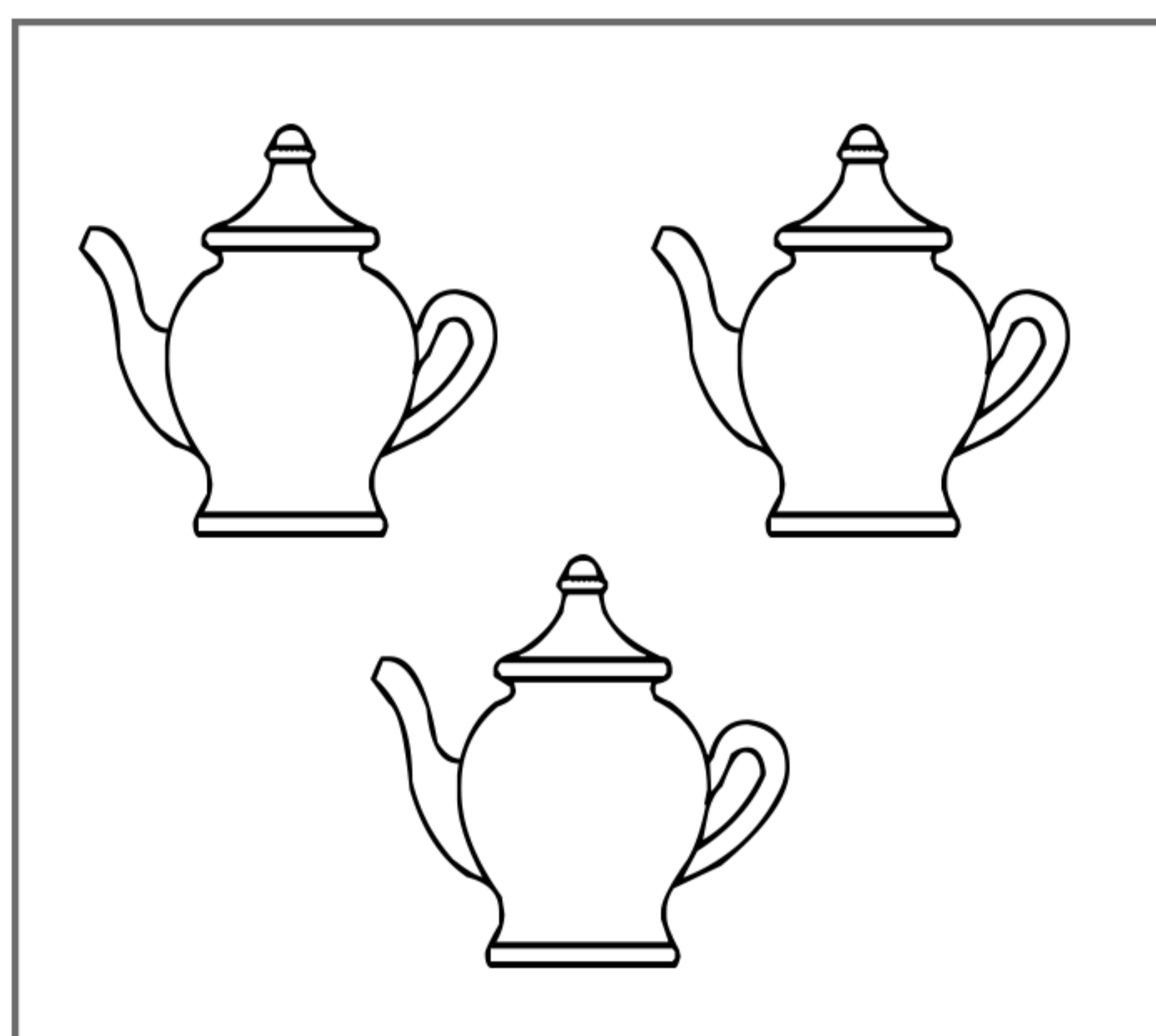
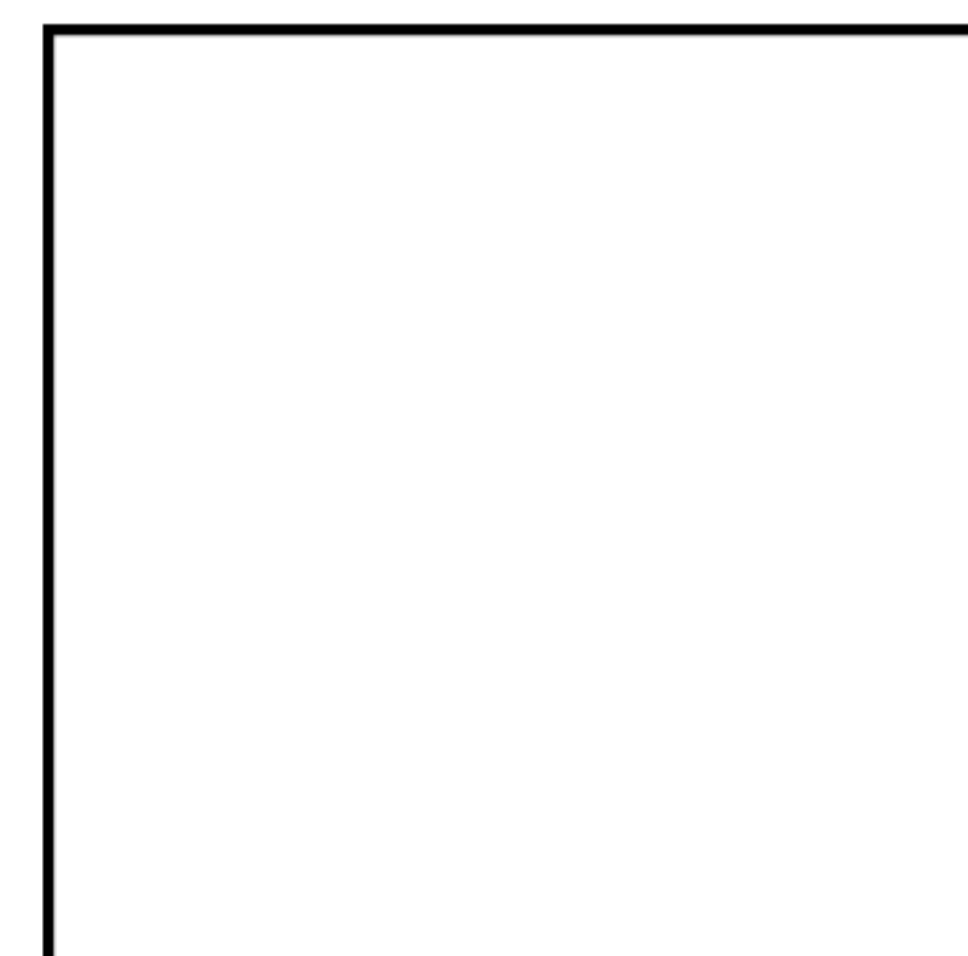

+

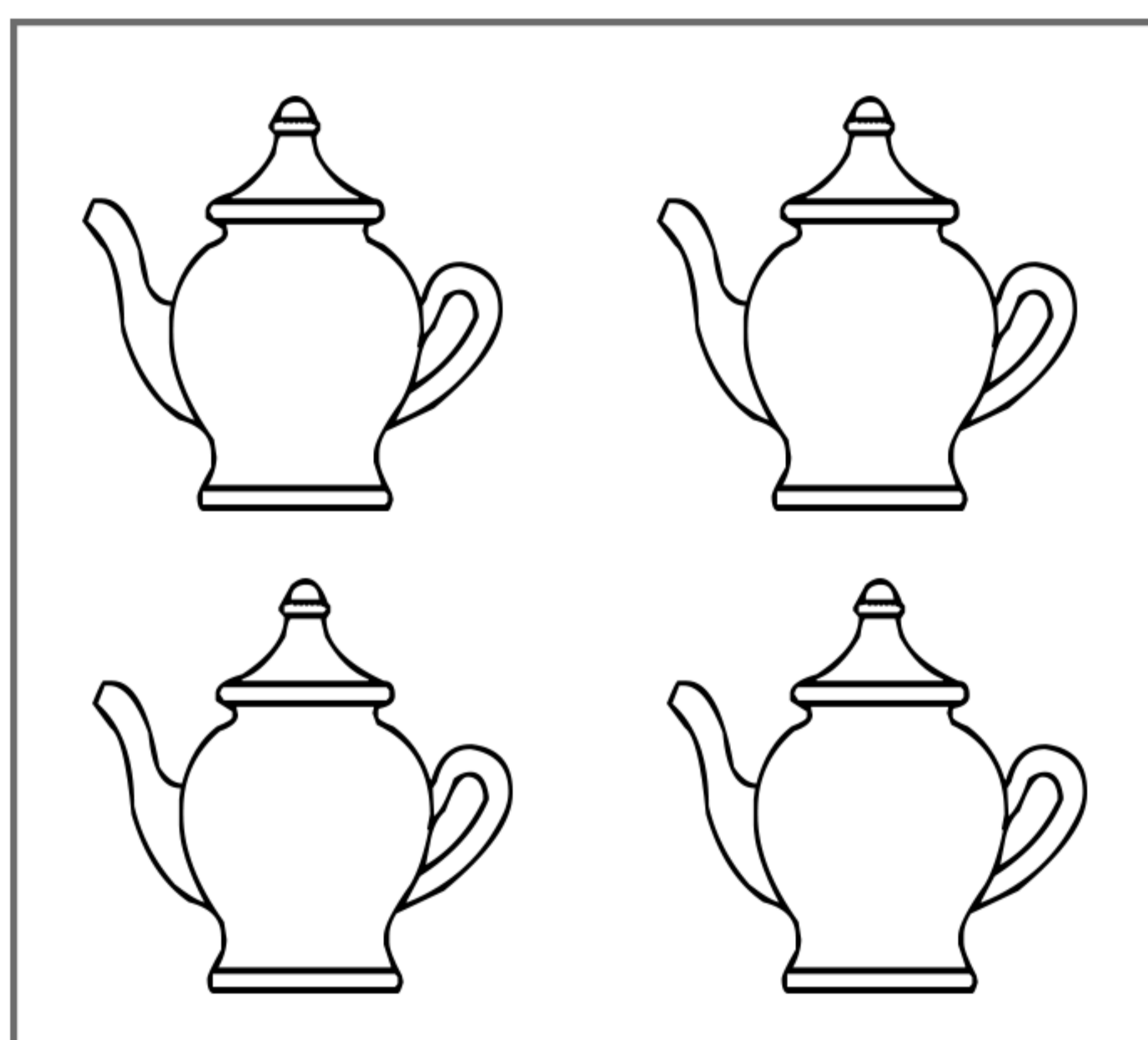

=

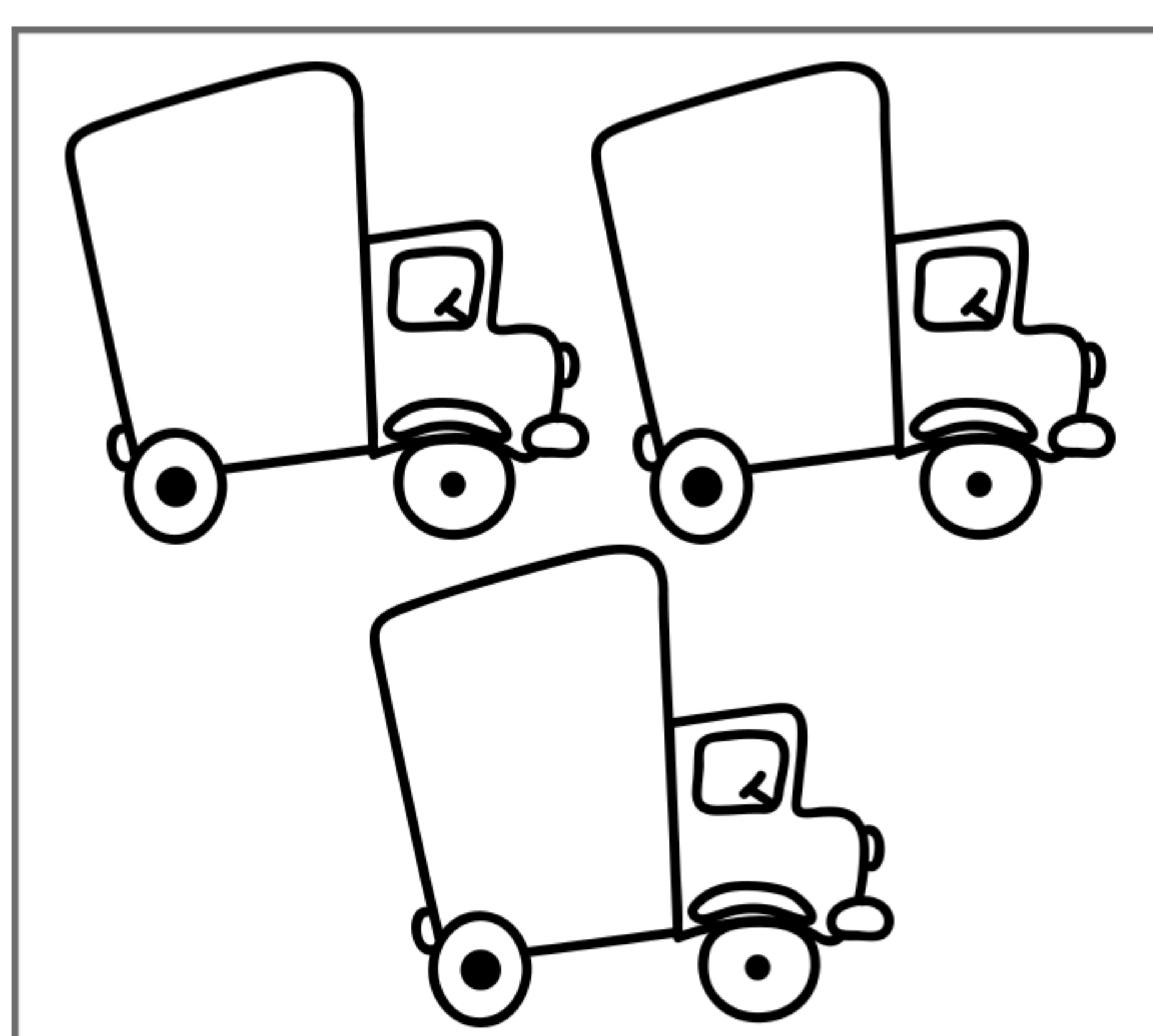
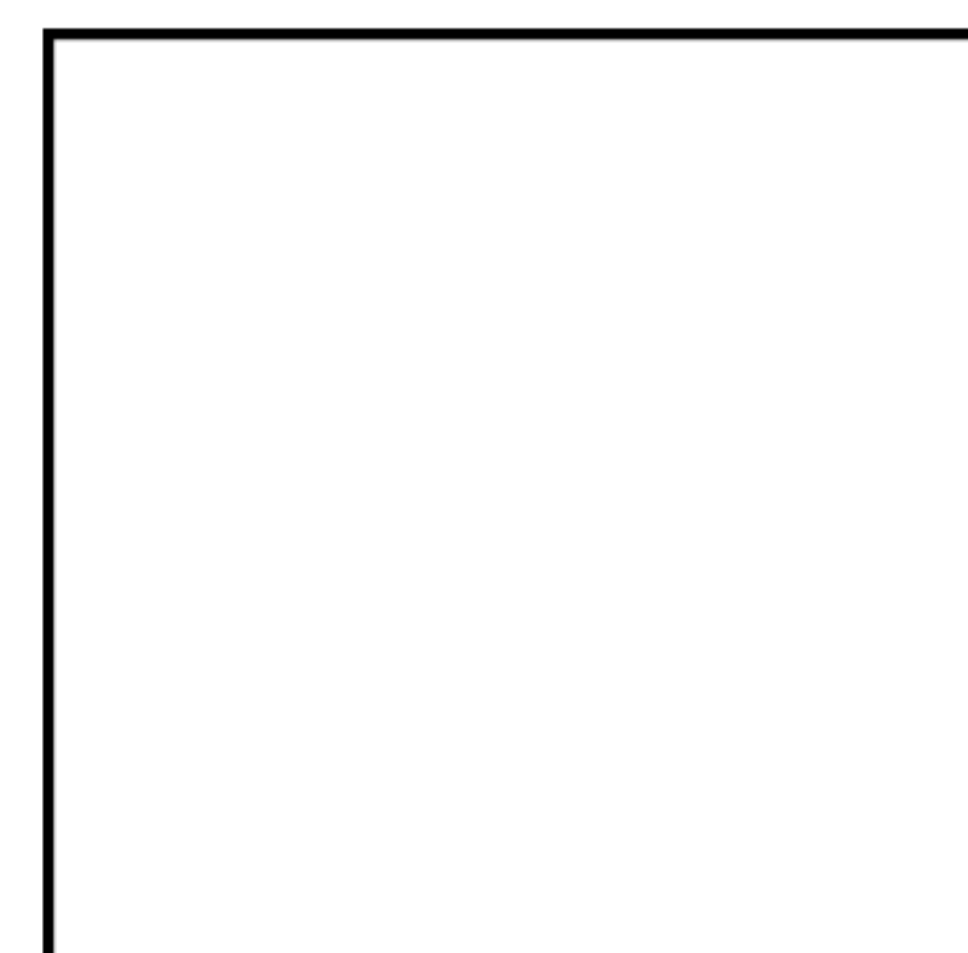

+

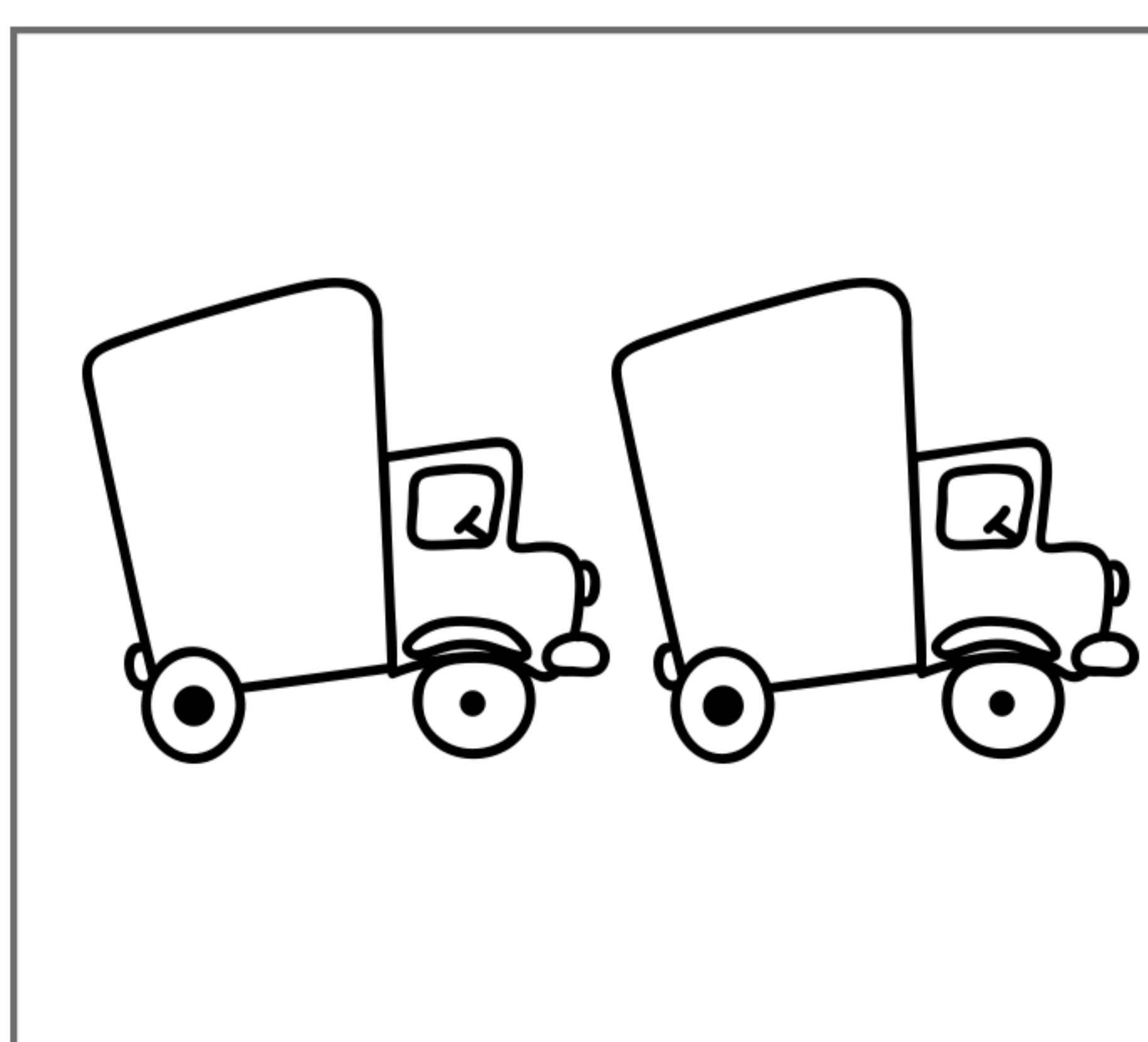

=

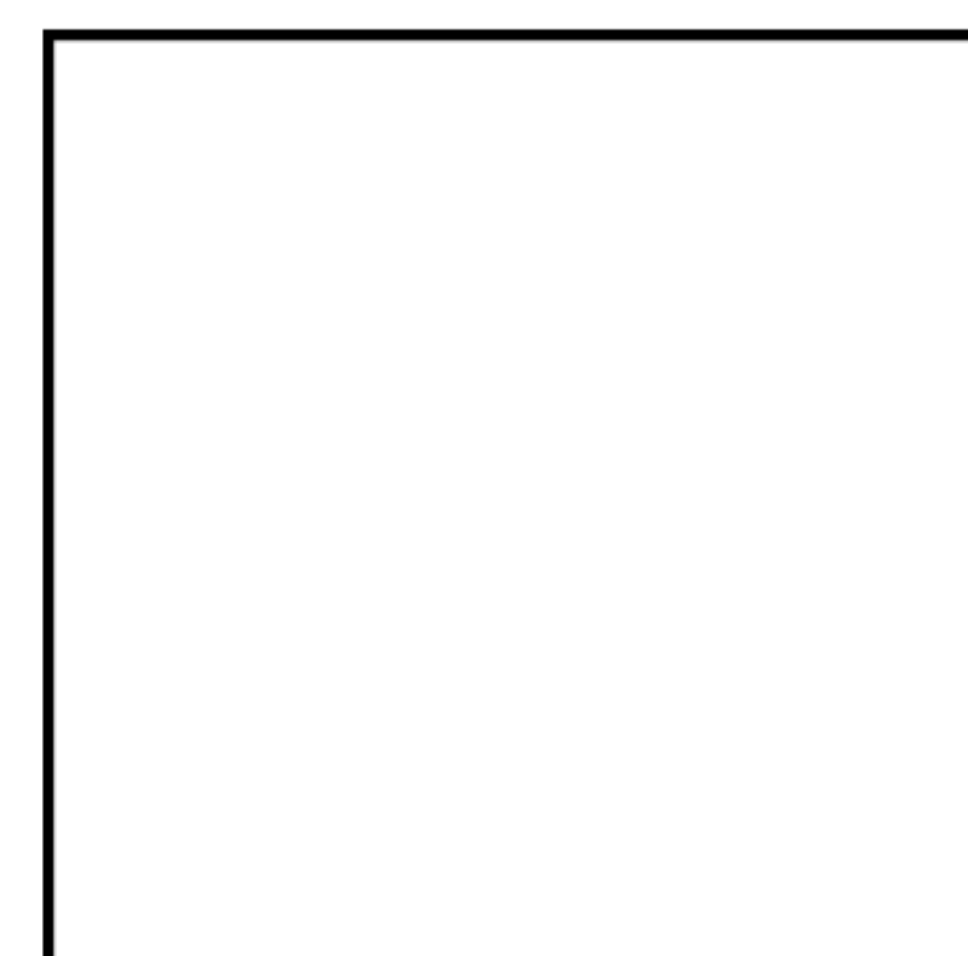

# Addizioni con i disegni

- Conta, somma e scrivi il risultato nel riquadro di destra.

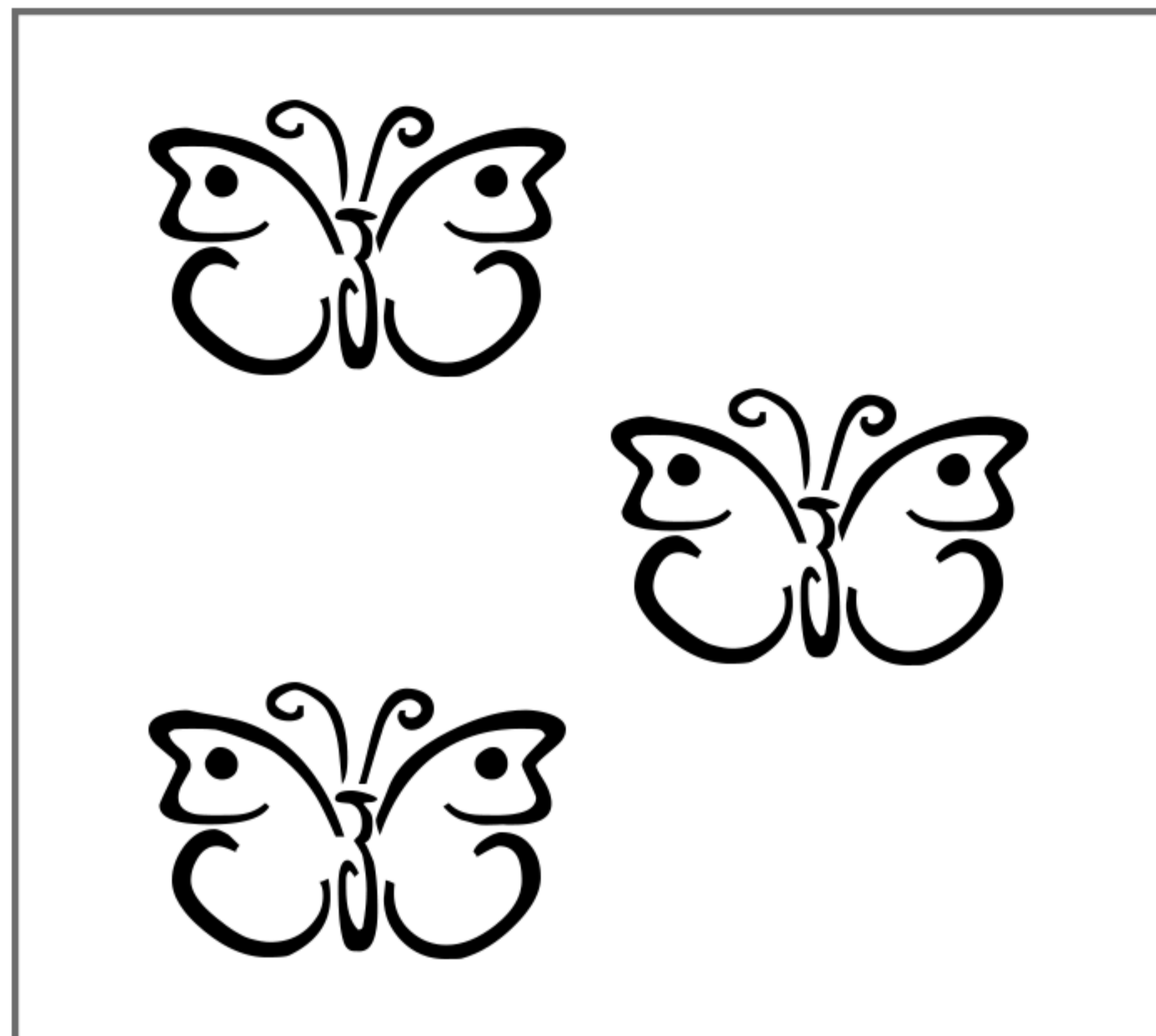

+

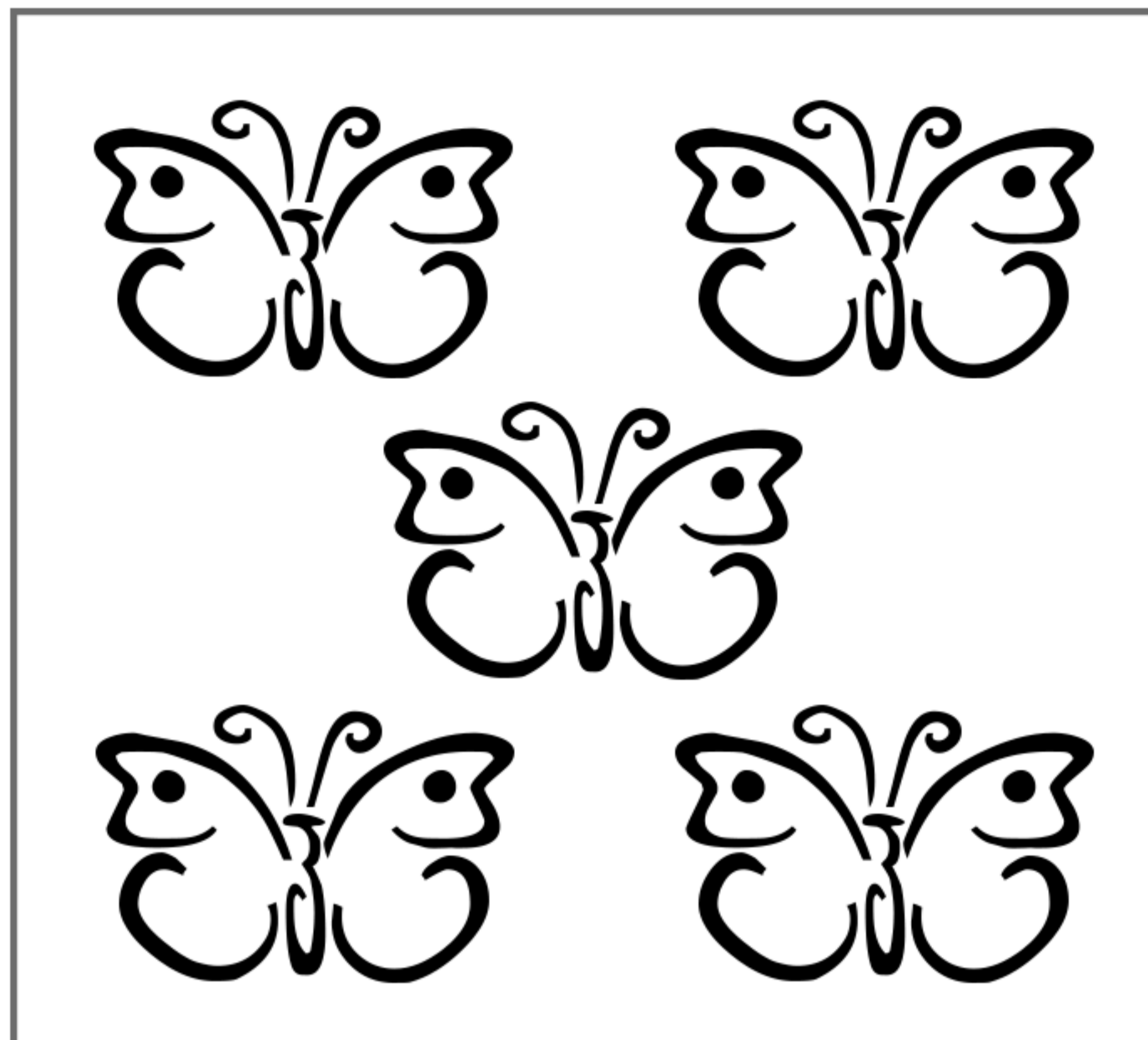

=

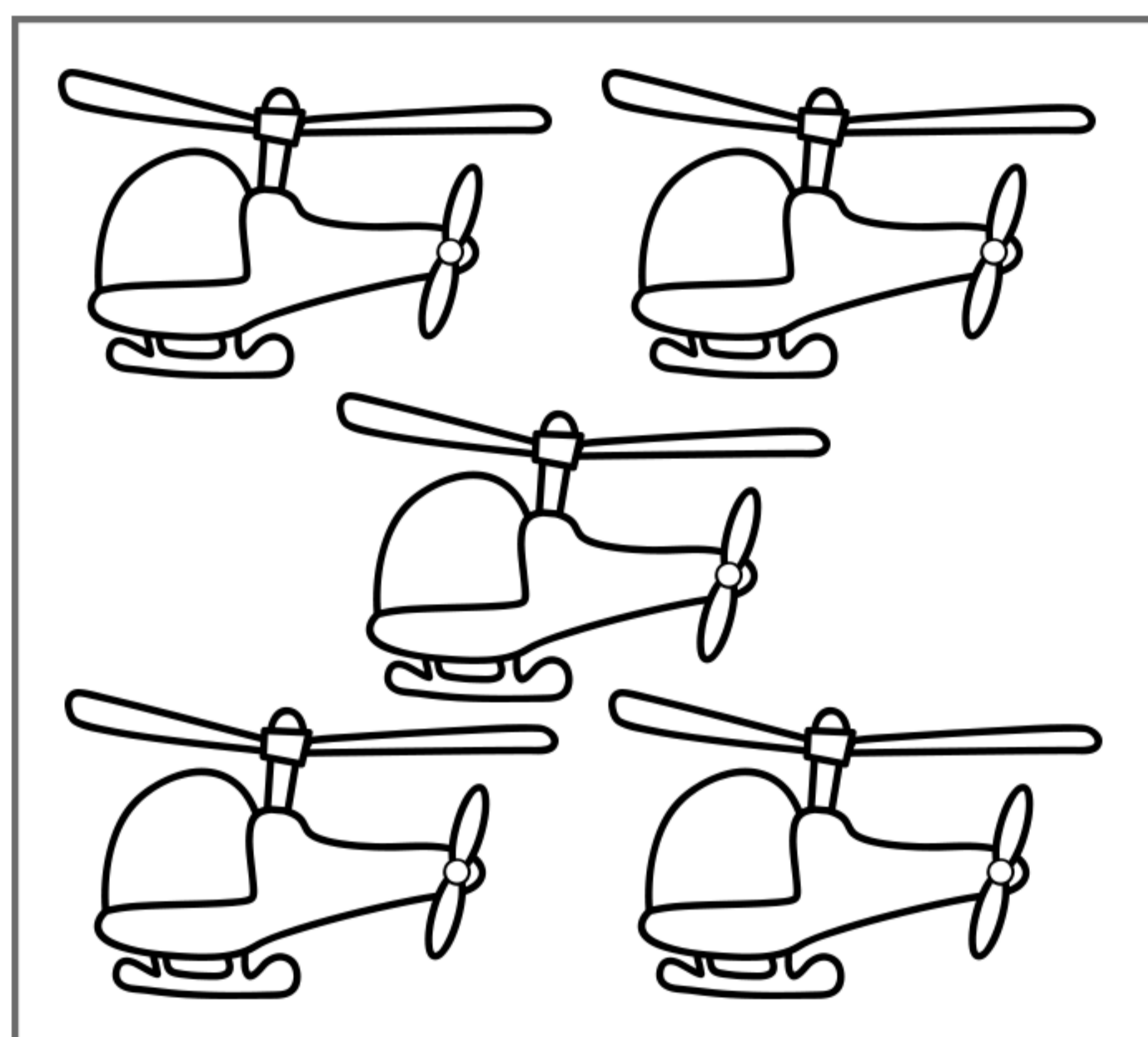
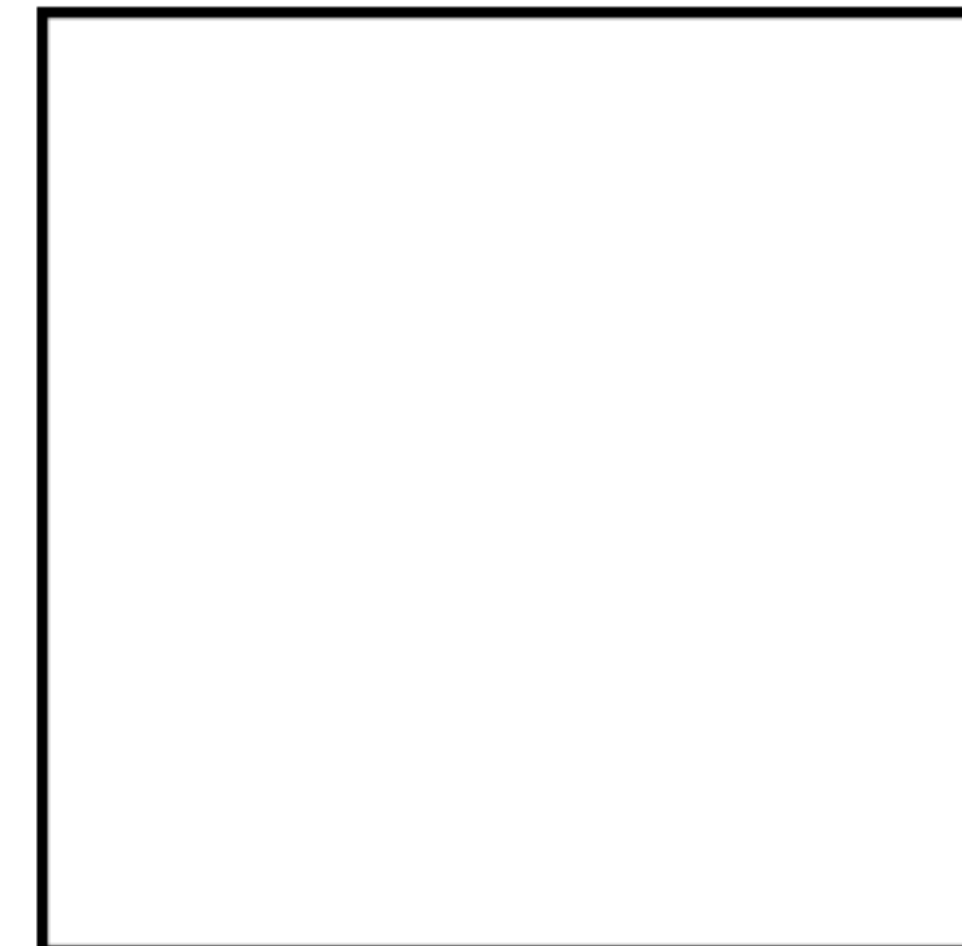

+

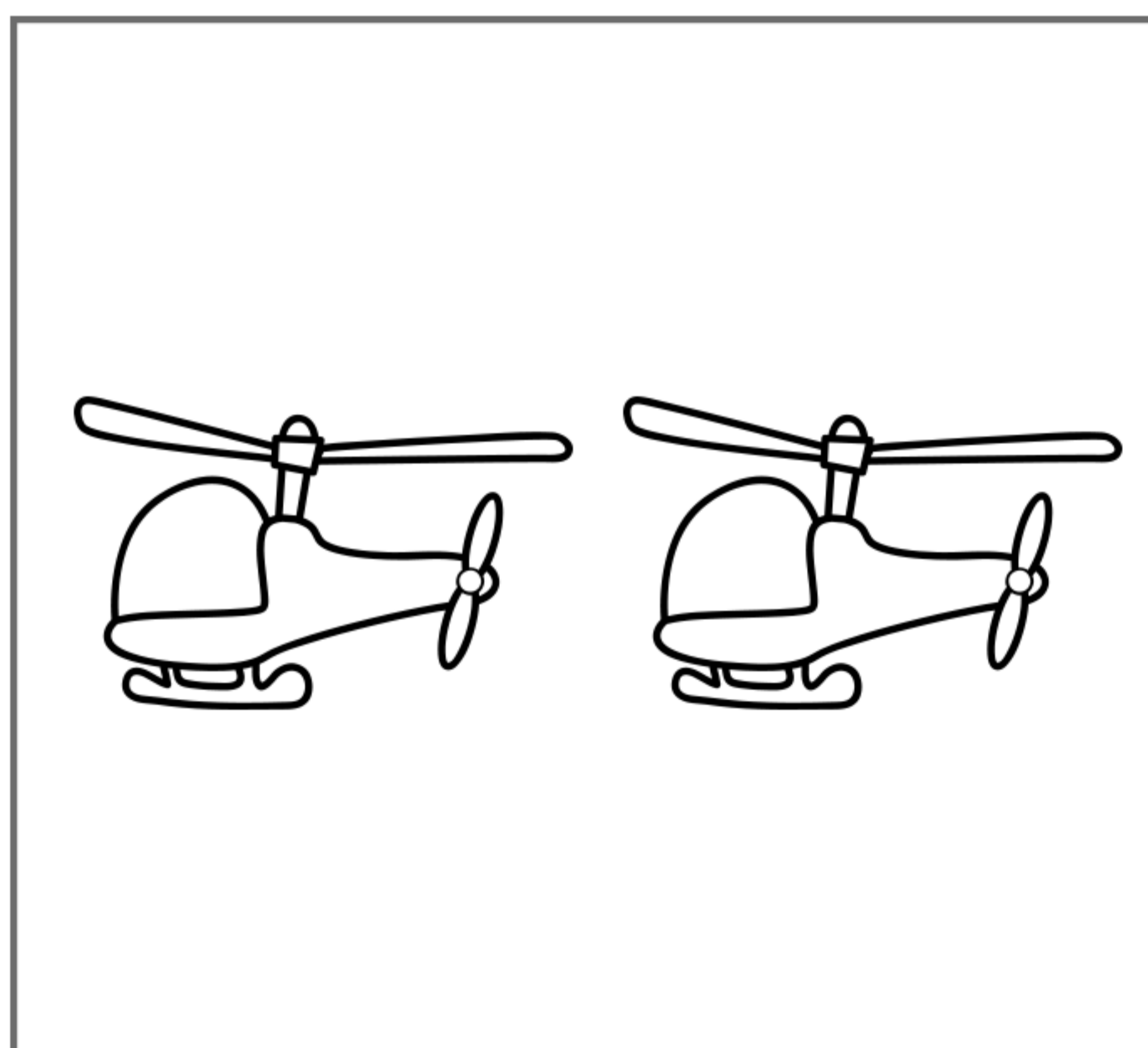

=

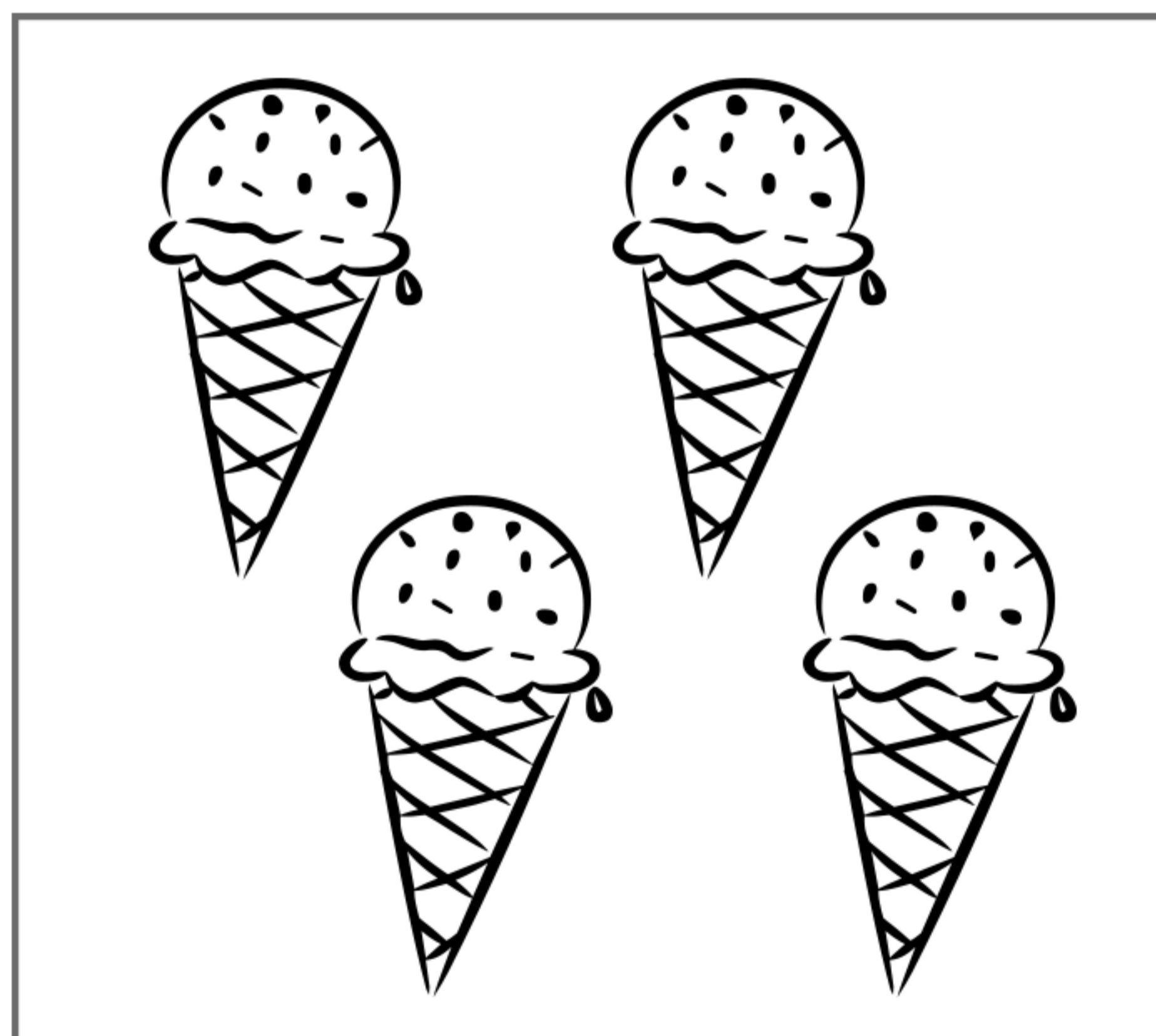
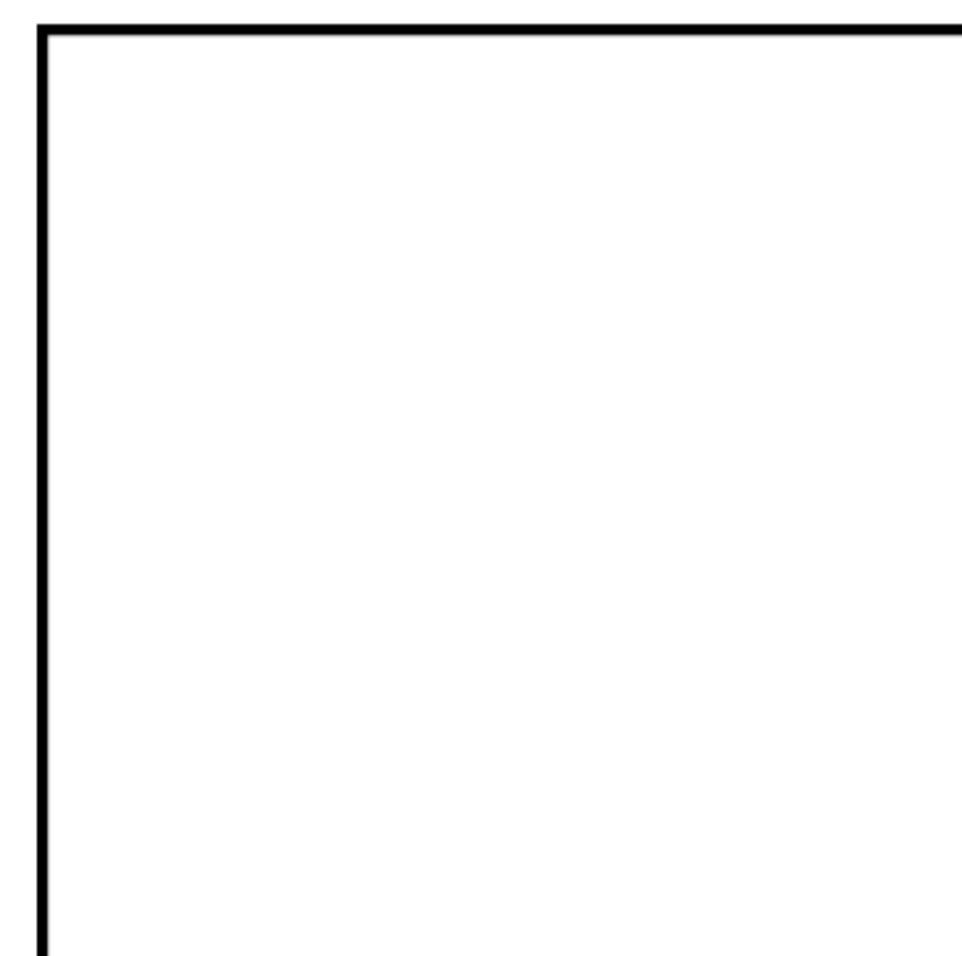

+

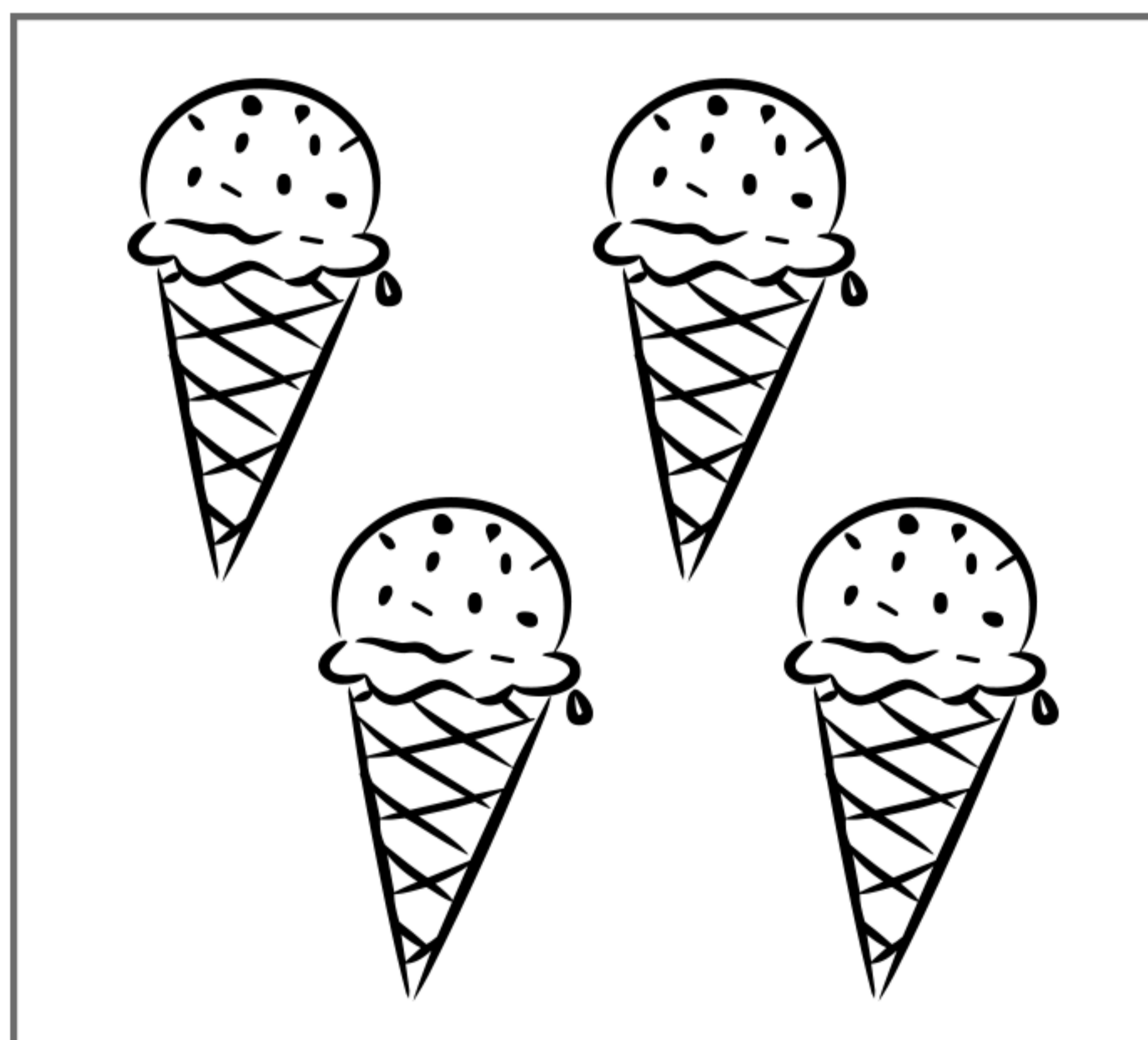

=

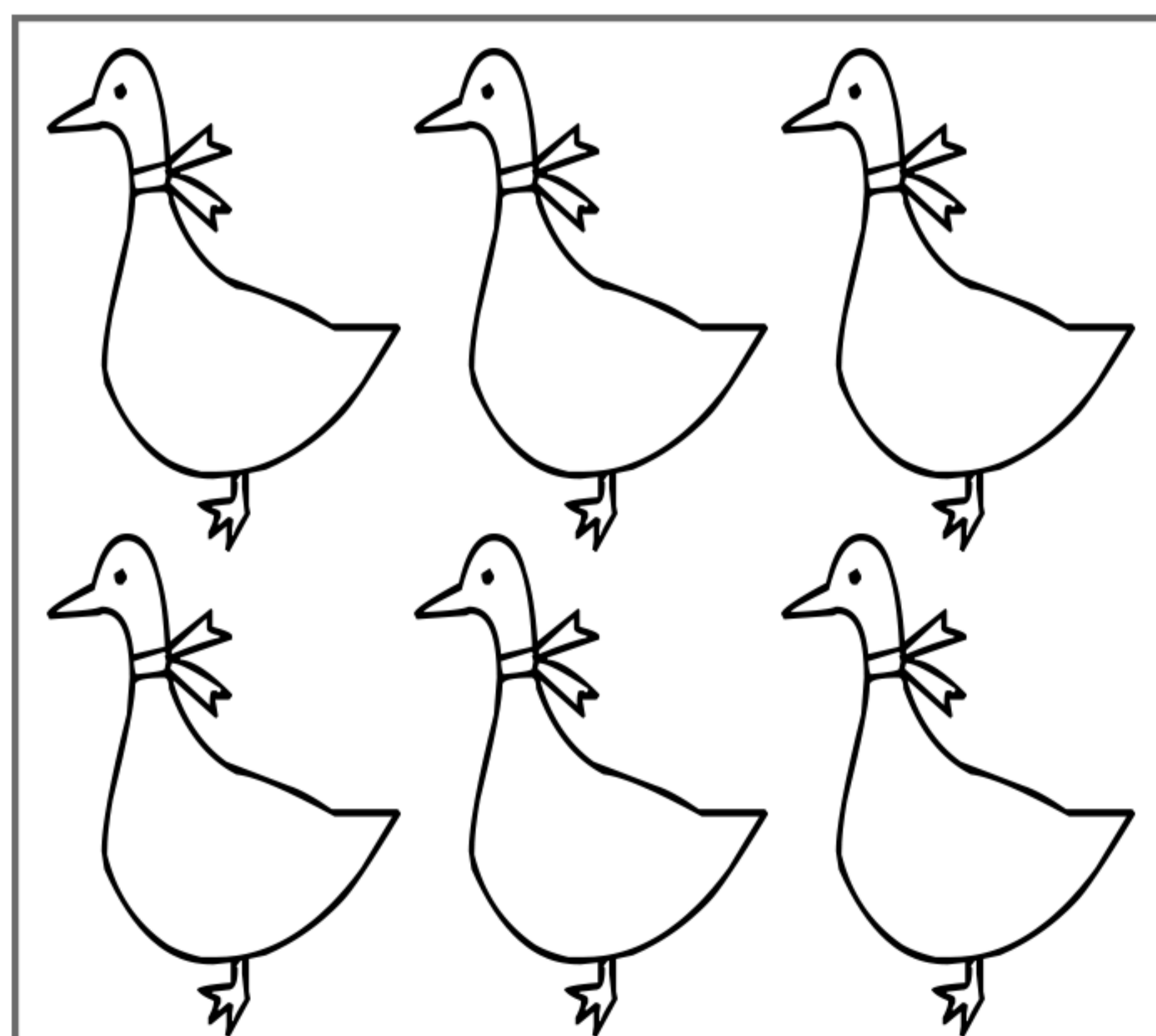
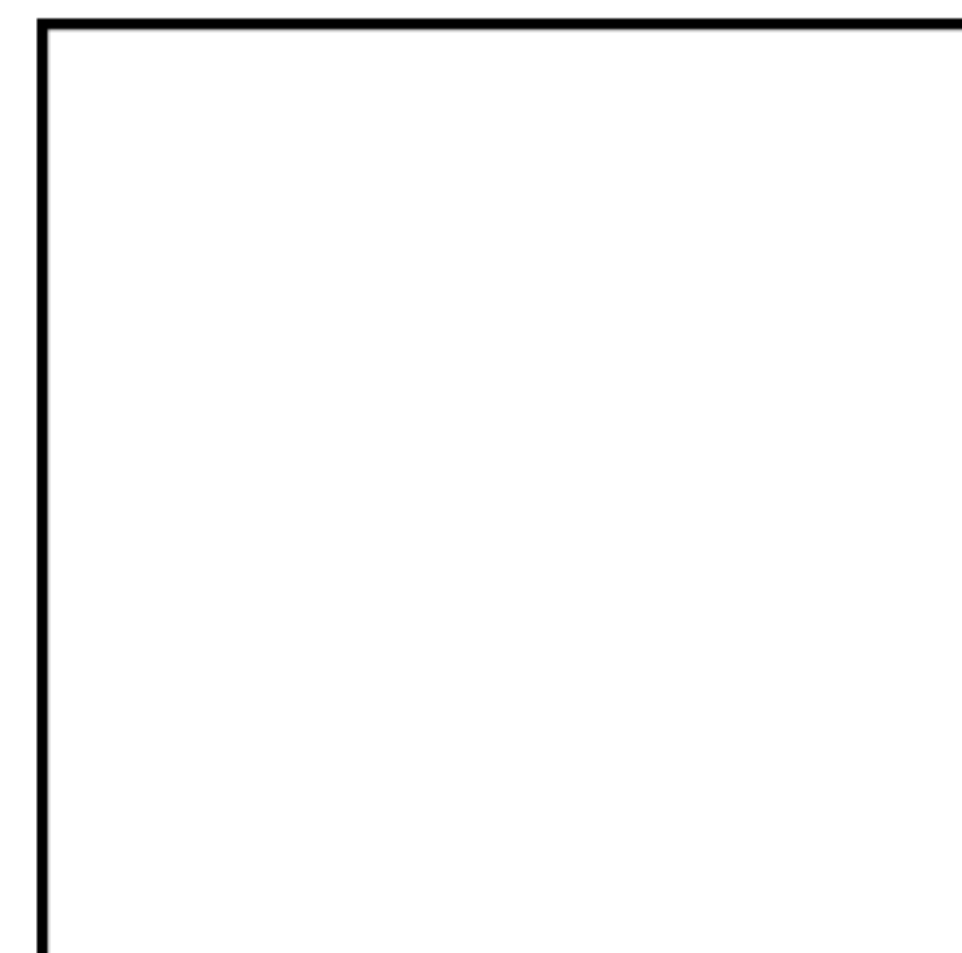

+

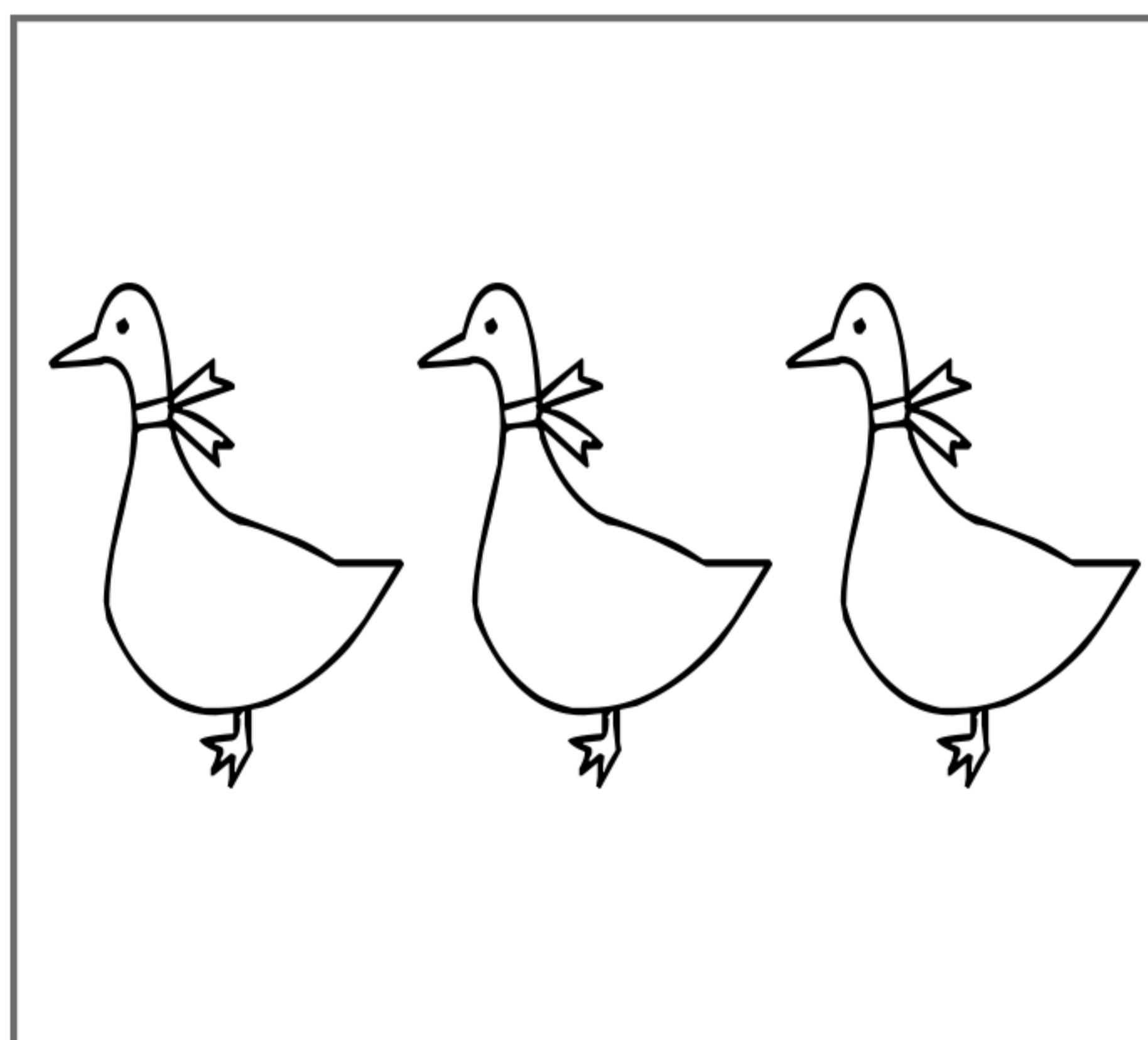

=

