

Forme e figure

- Collega ogni oggetto alla forma nei riquadri che gli somiglia.

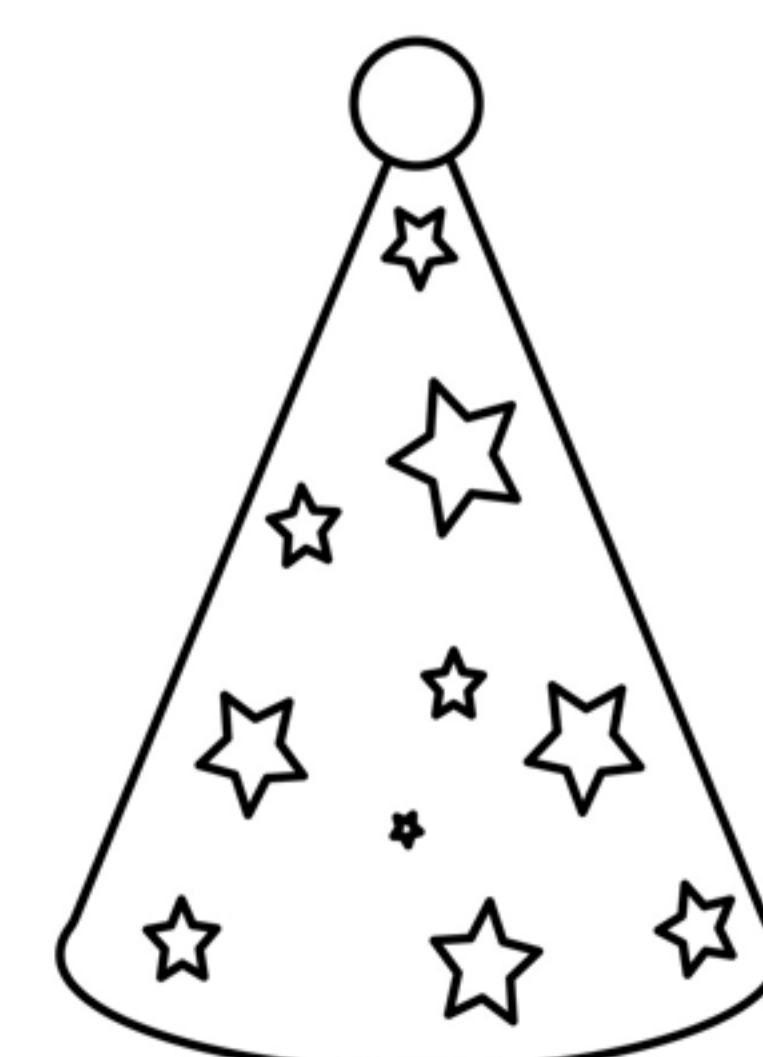
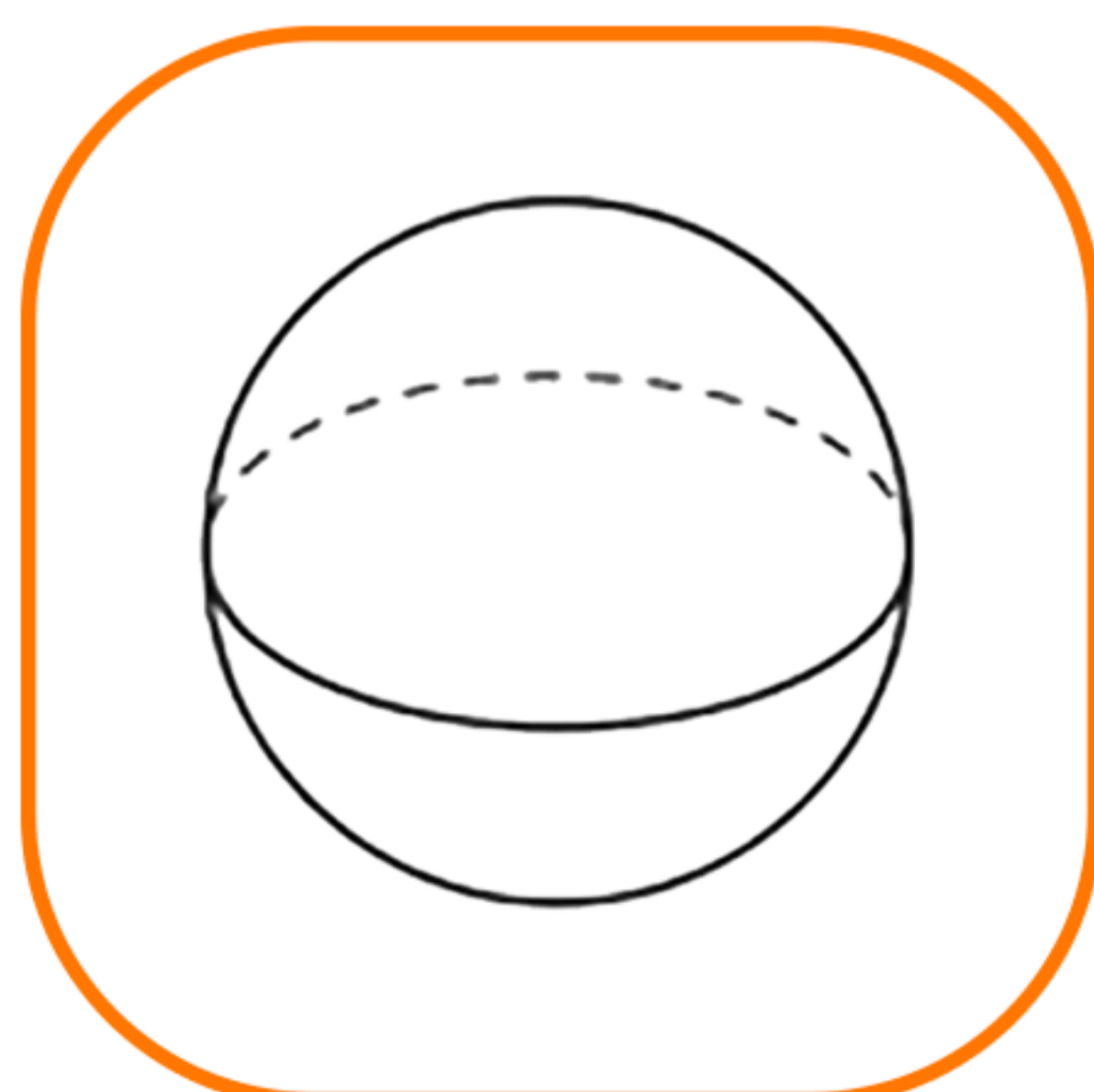
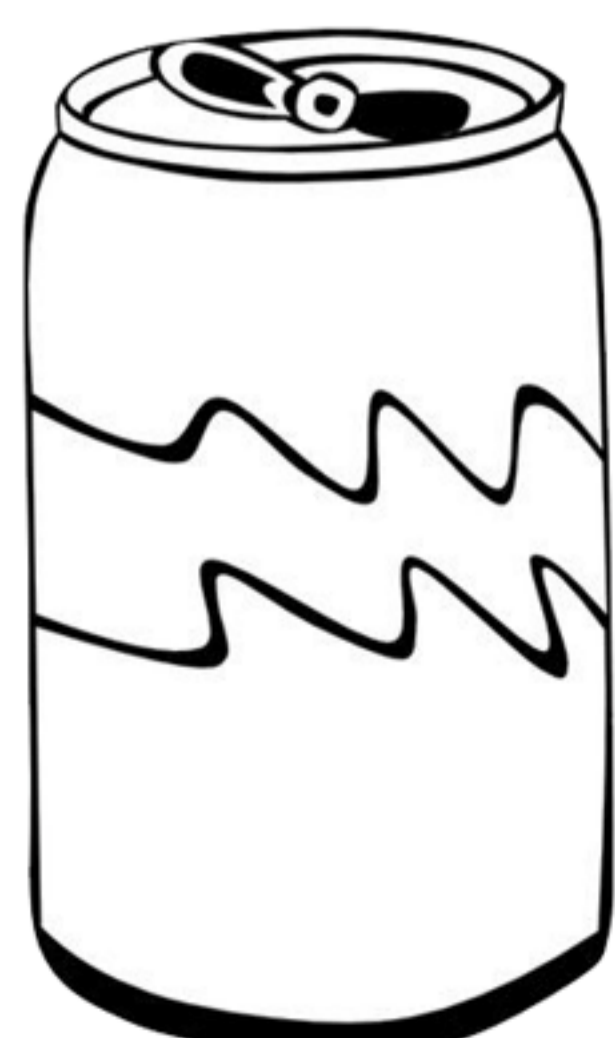
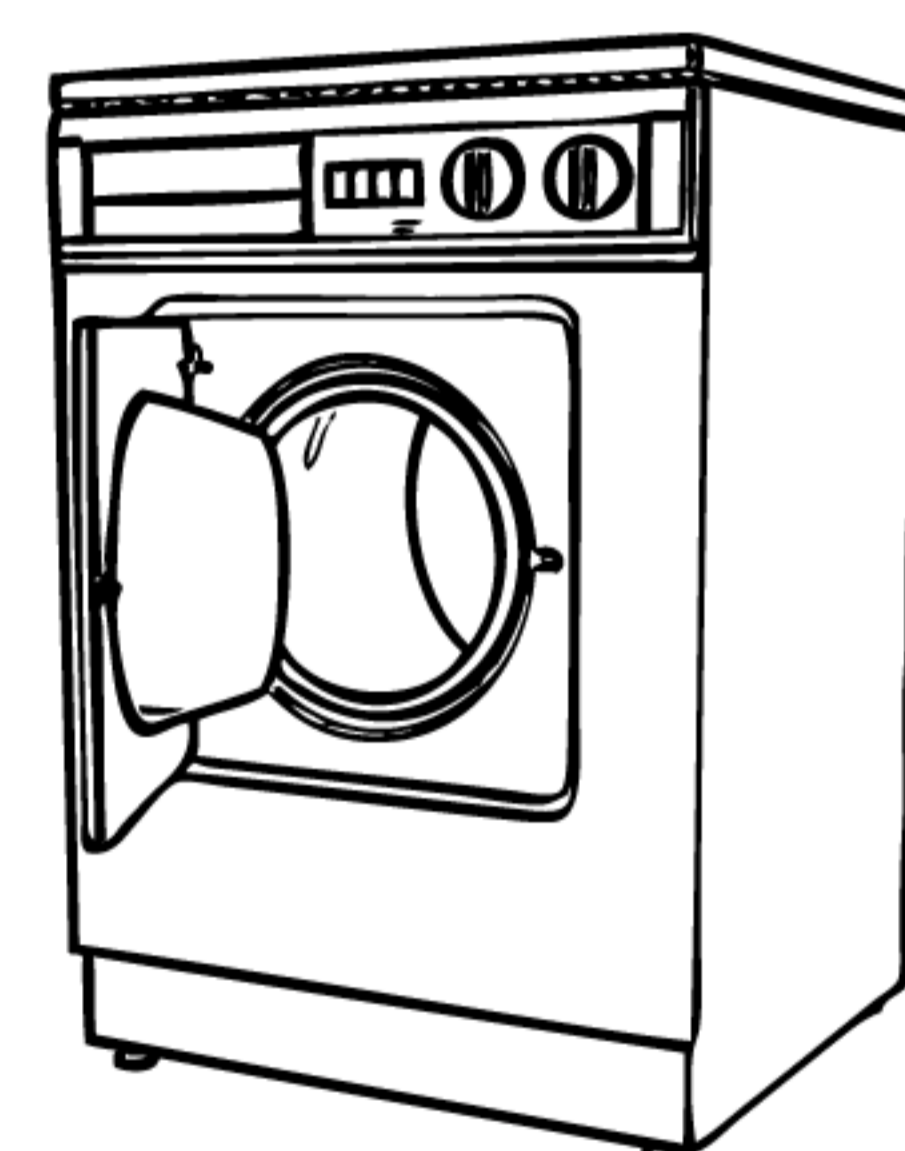
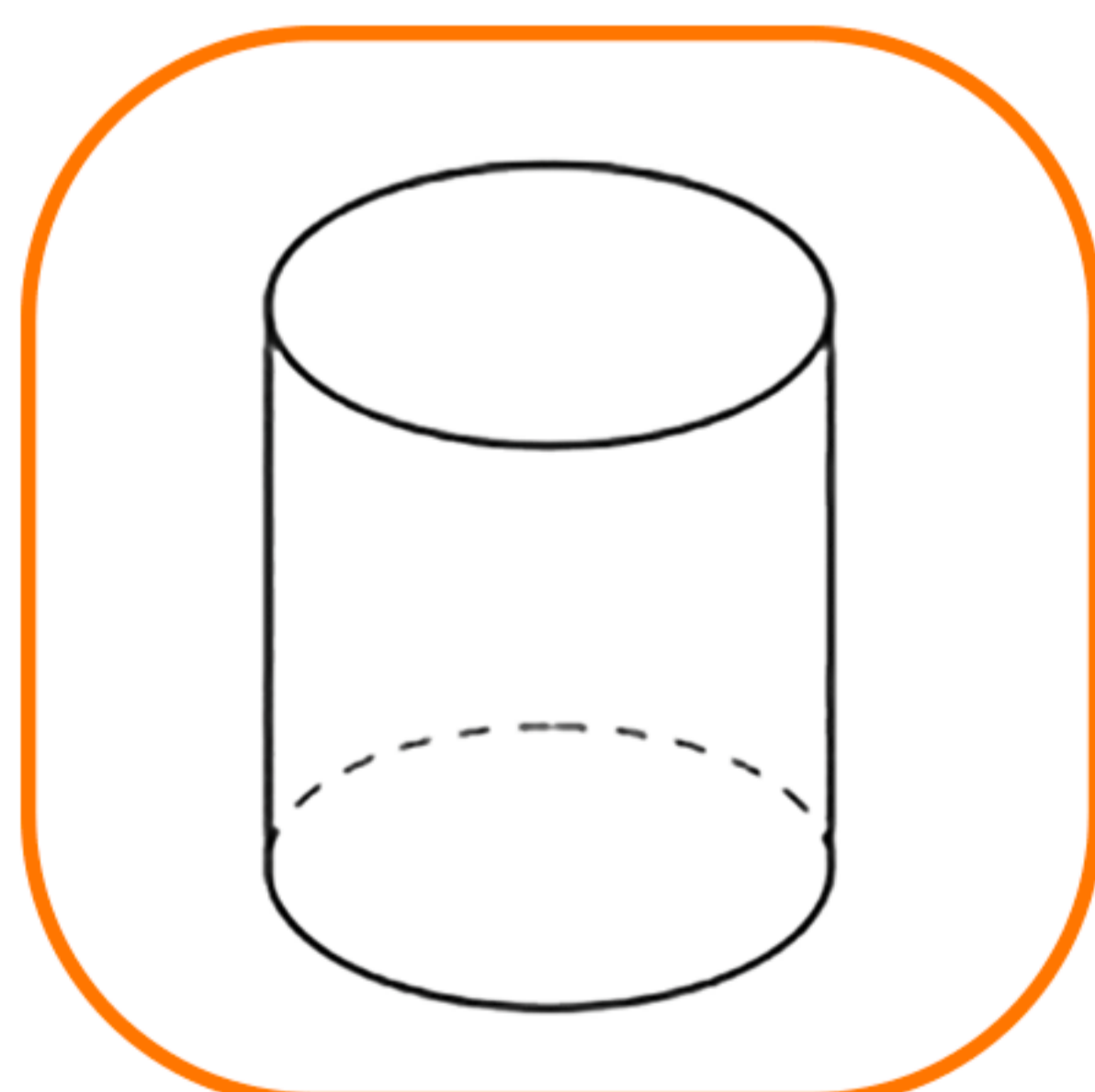
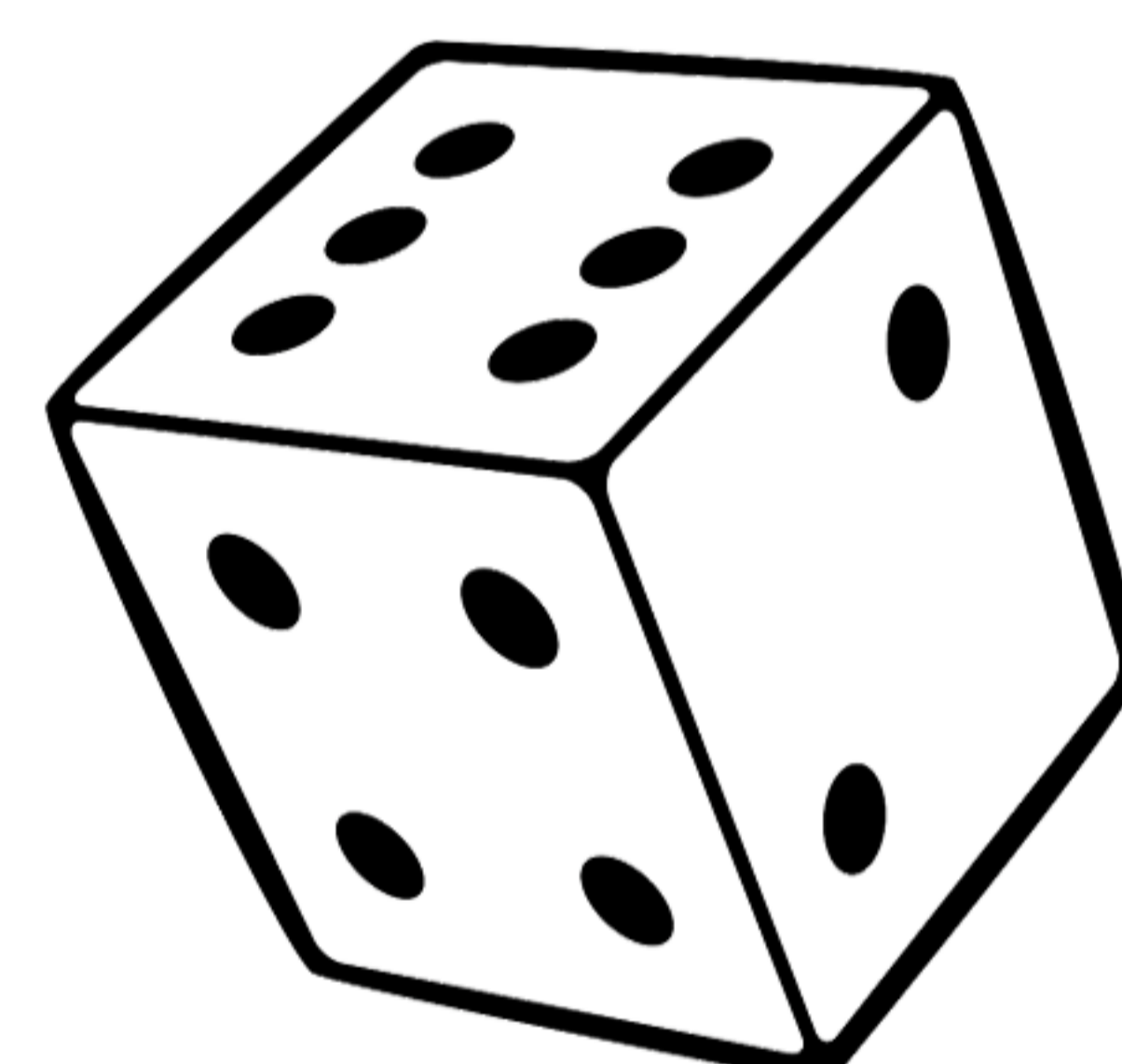
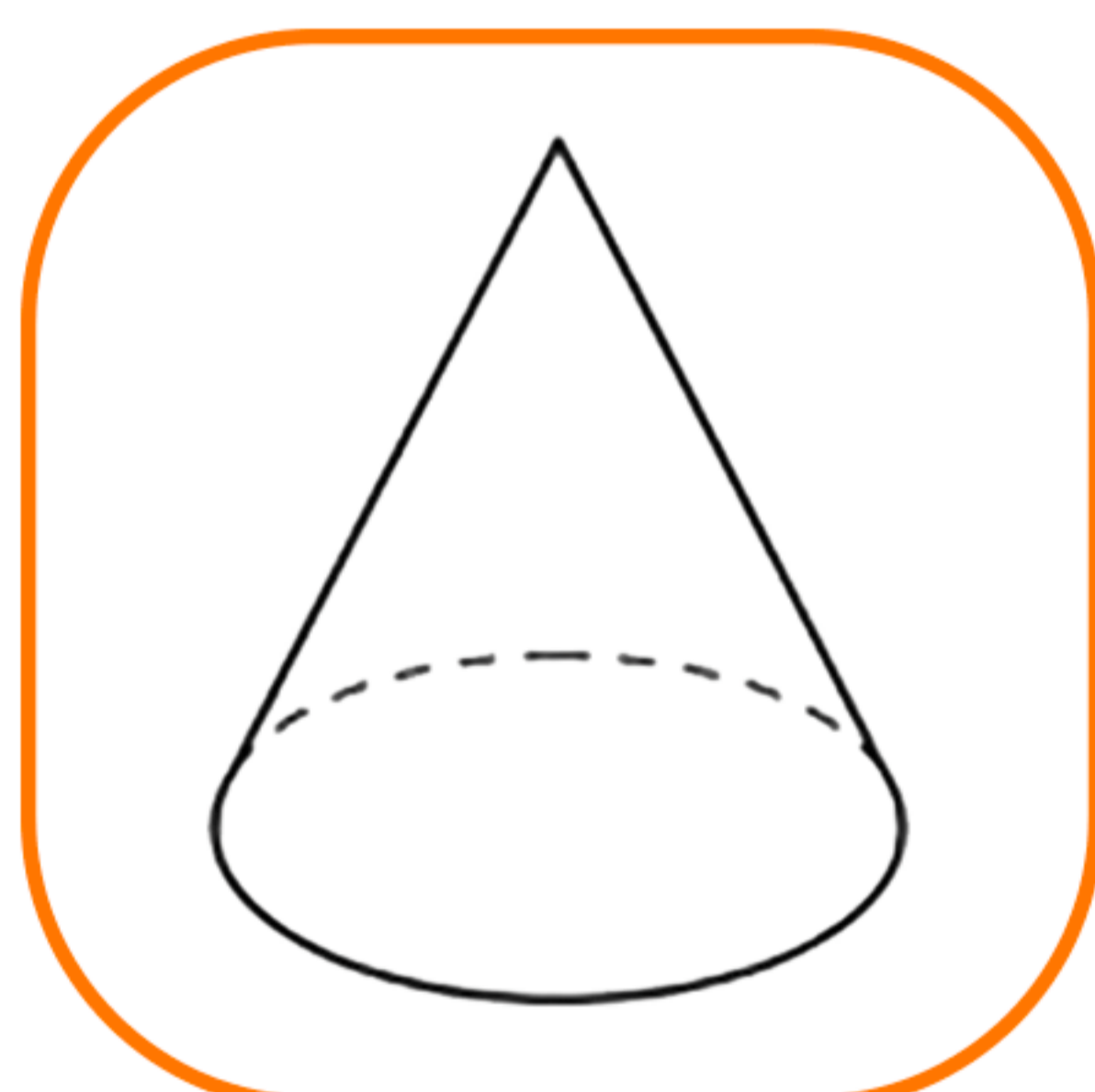
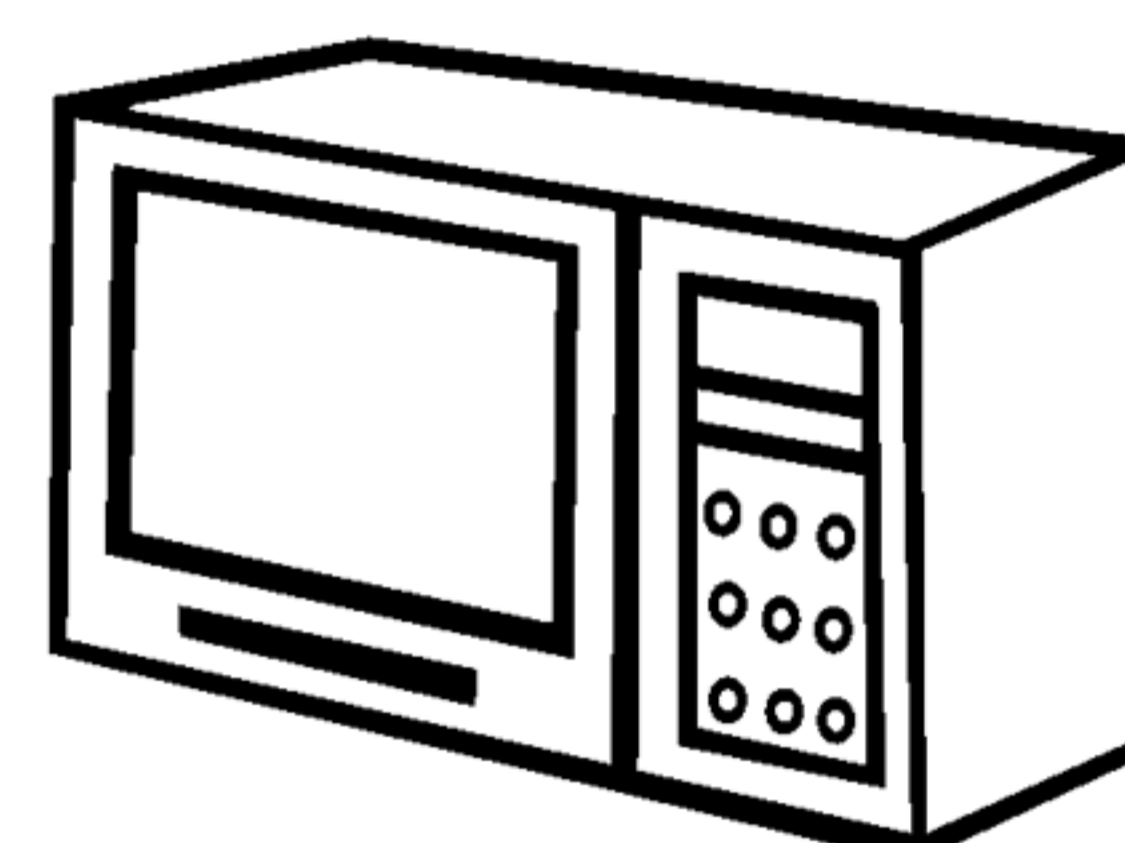
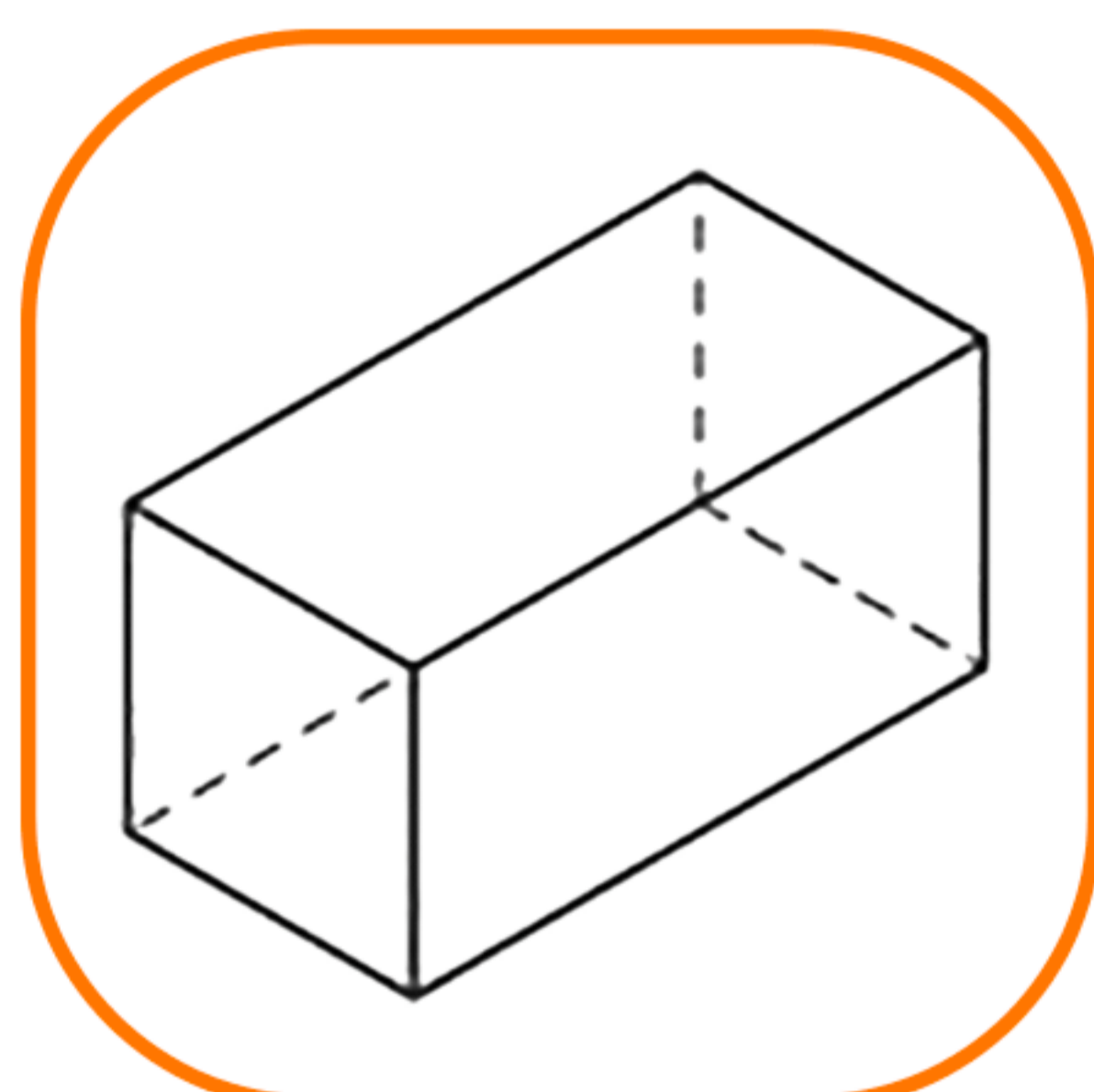
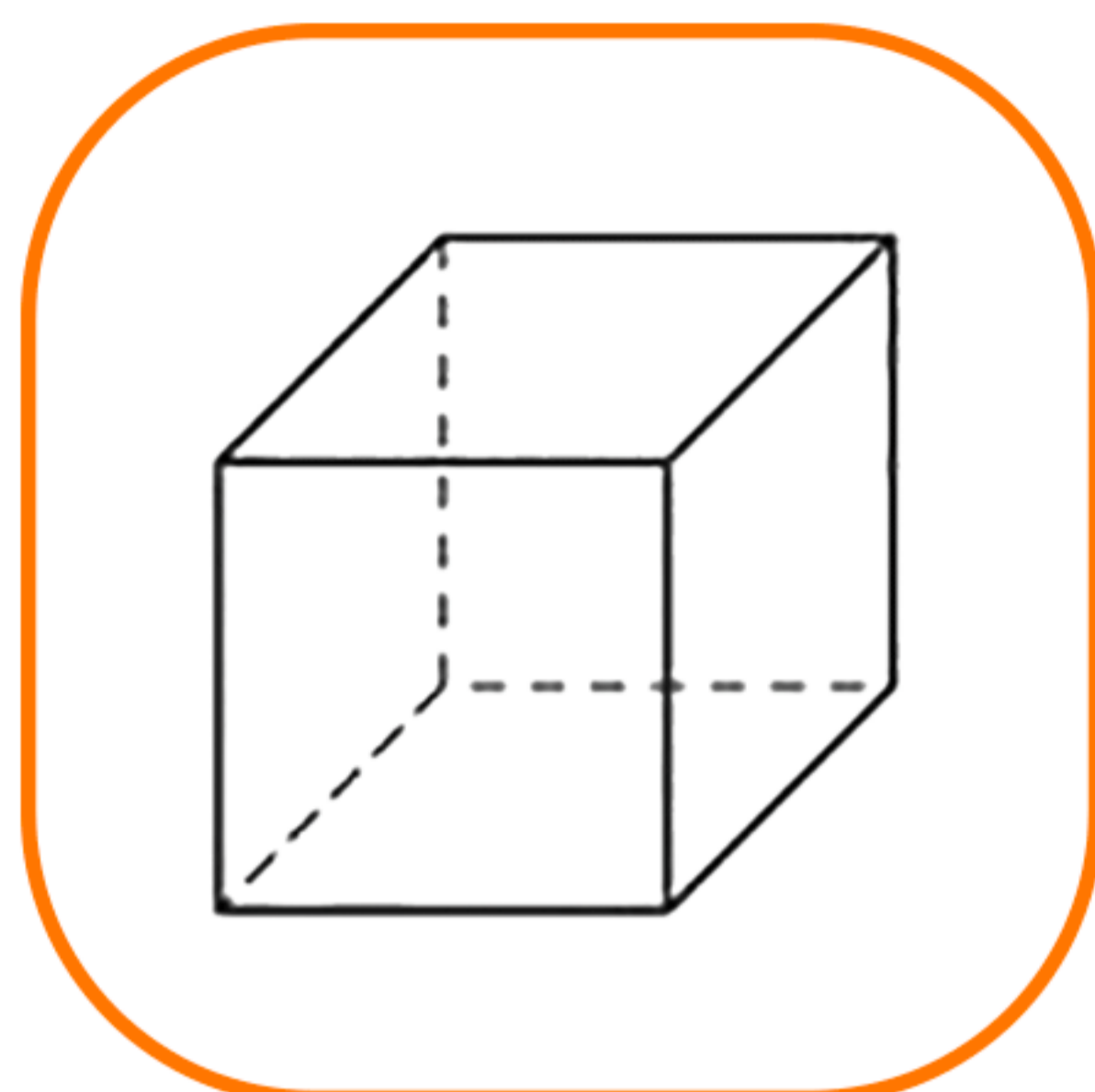
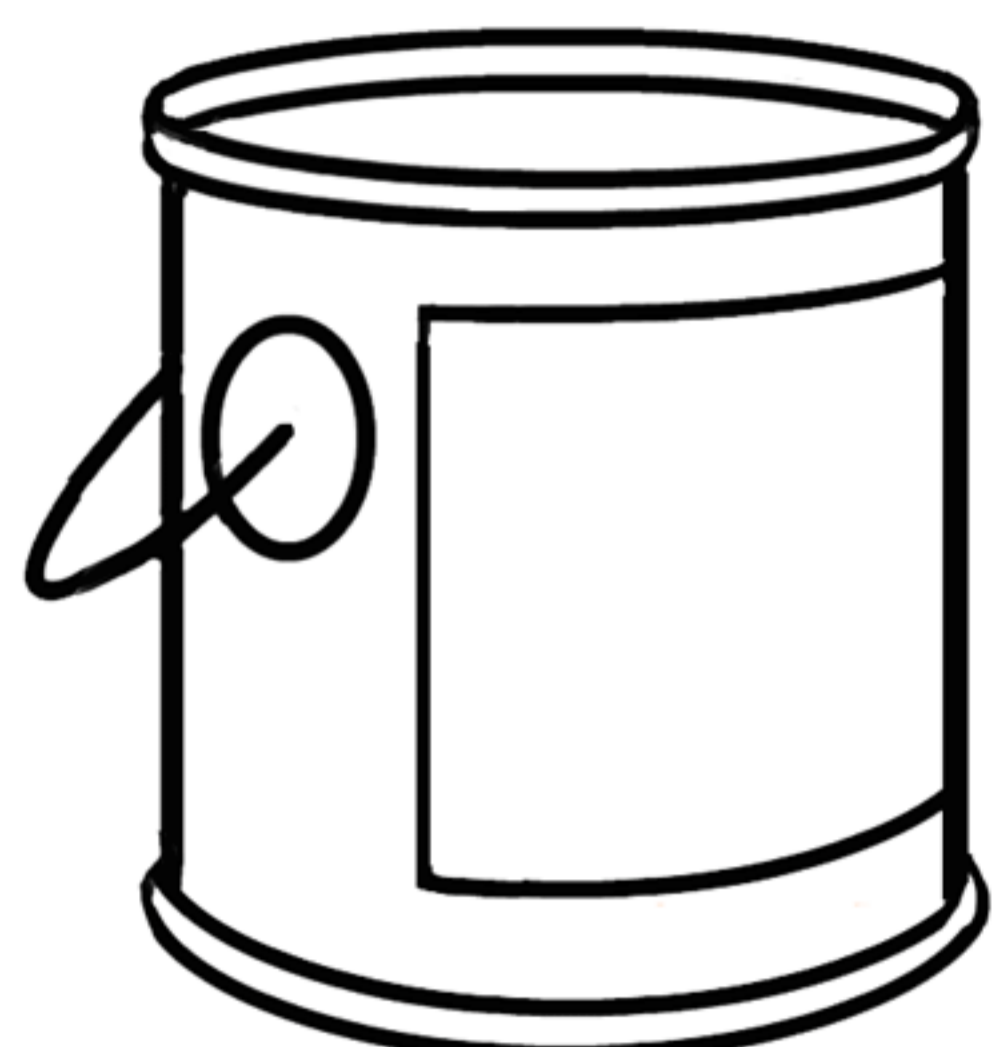

Forme e figure

- Collega ogni forma alla sua impronta.

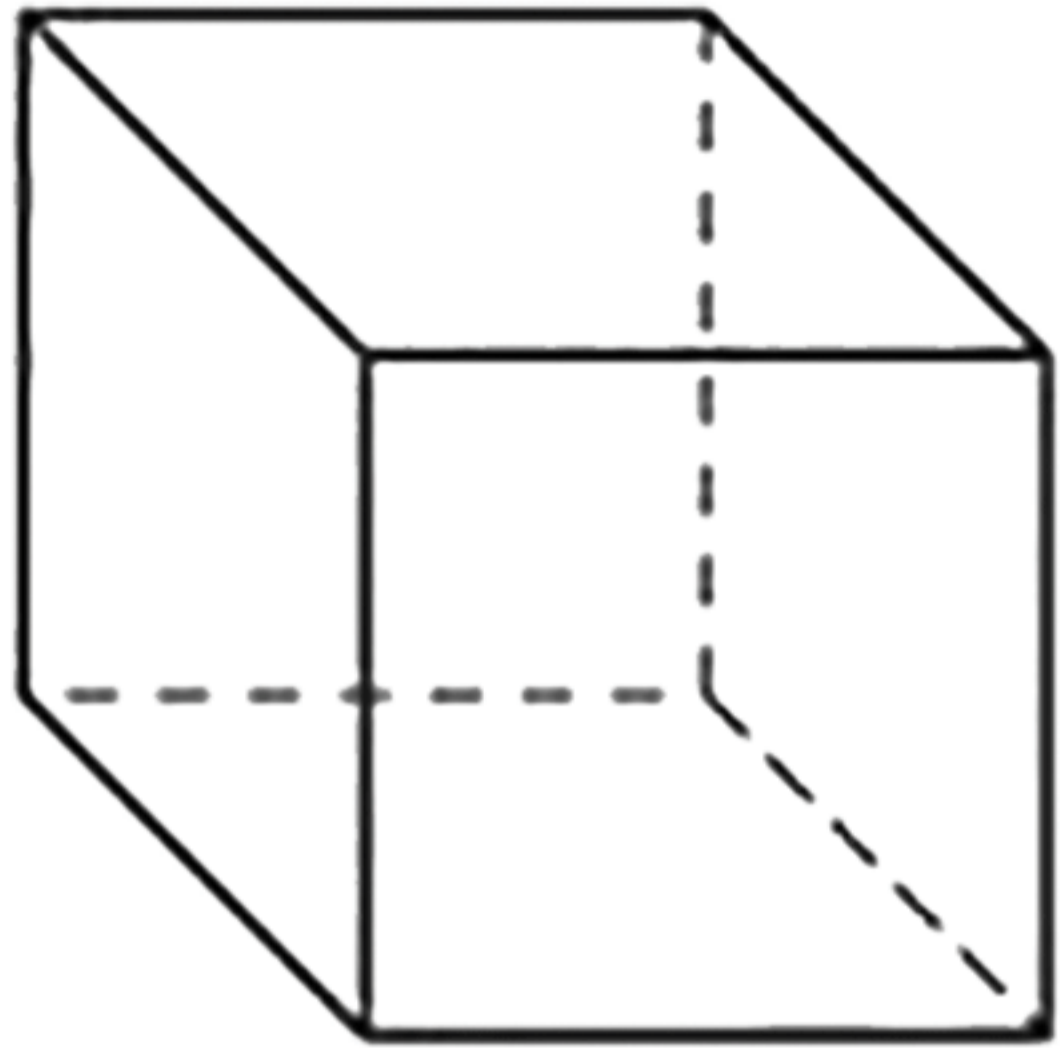

RETTANGOLO

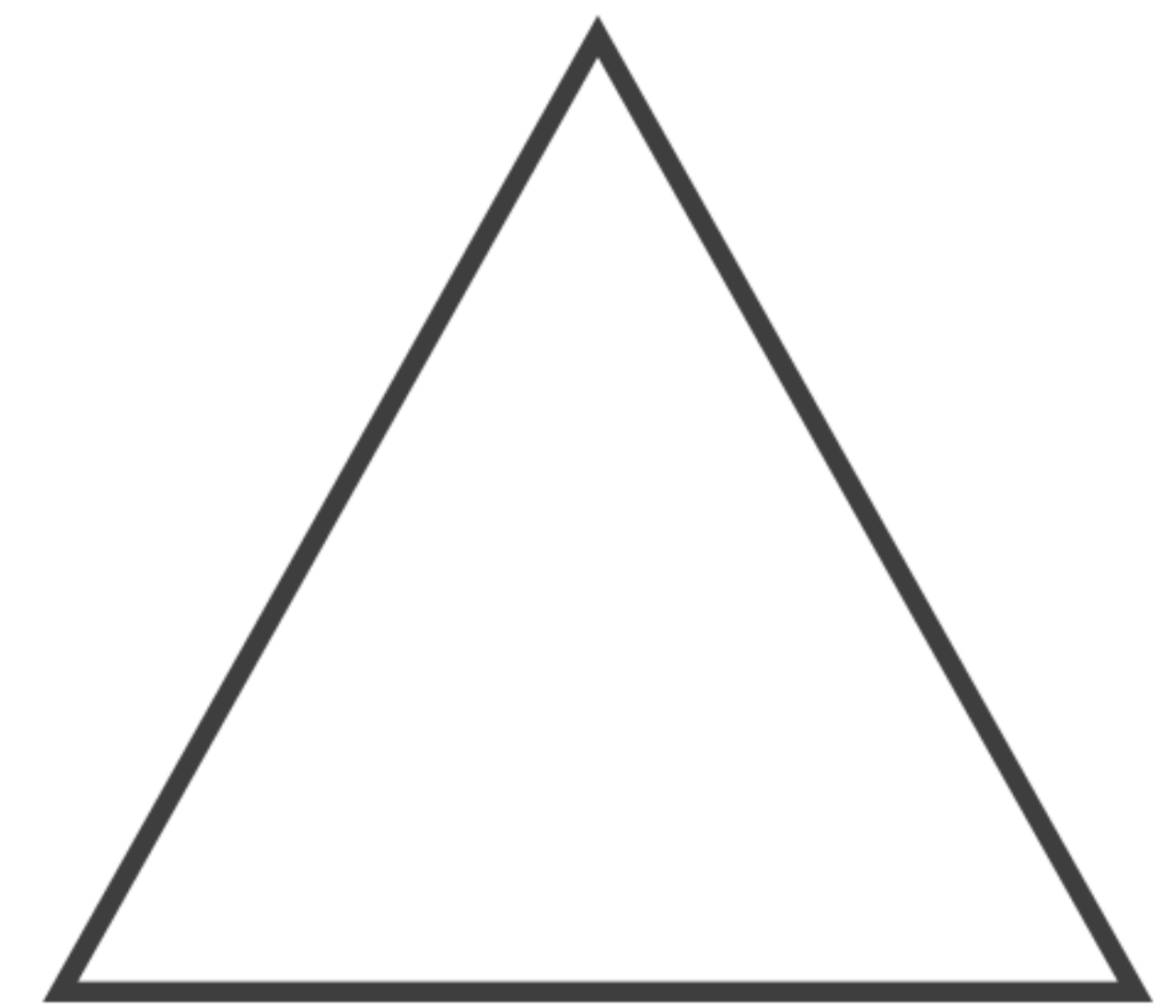
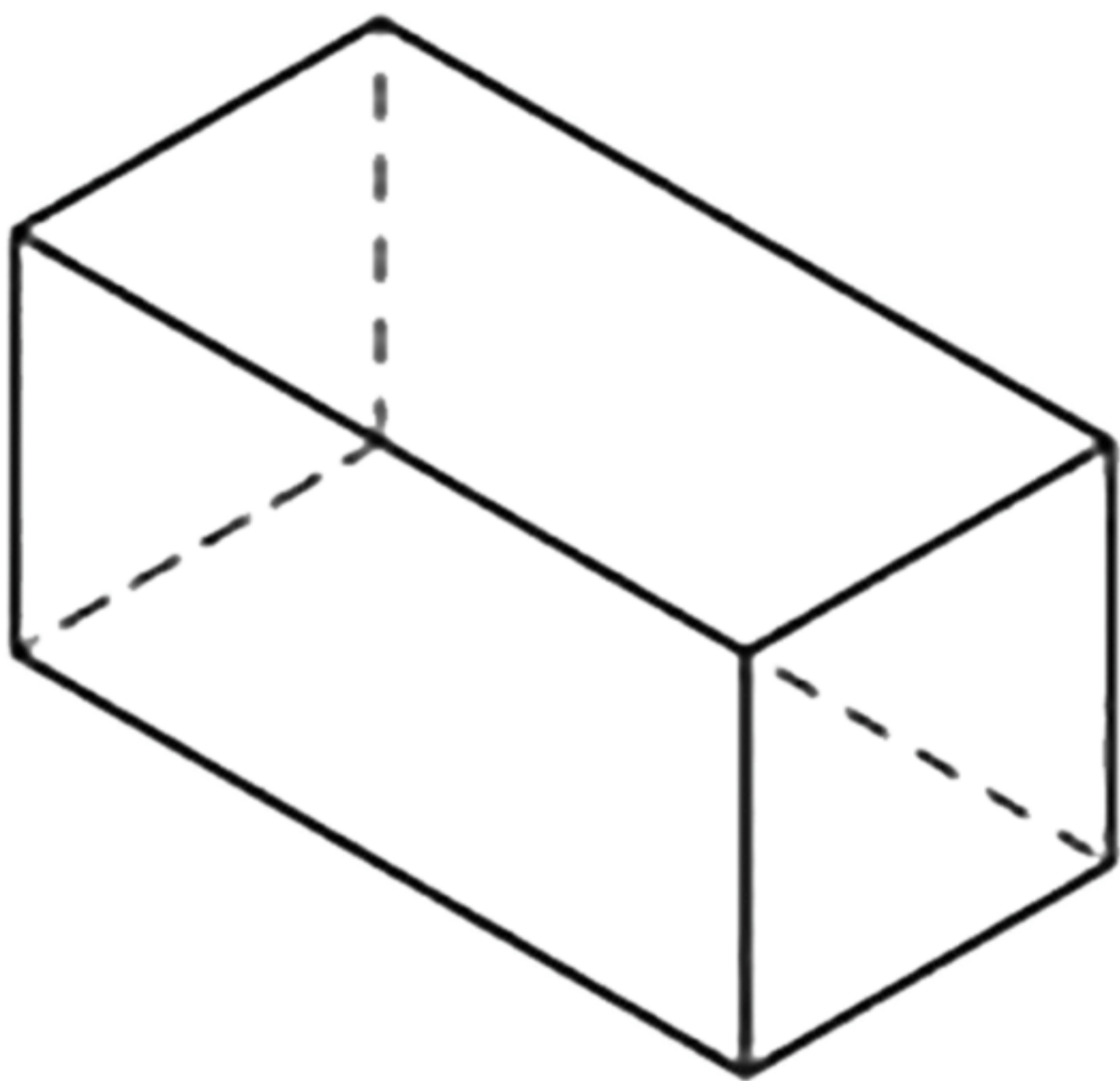

TRIANGOLO

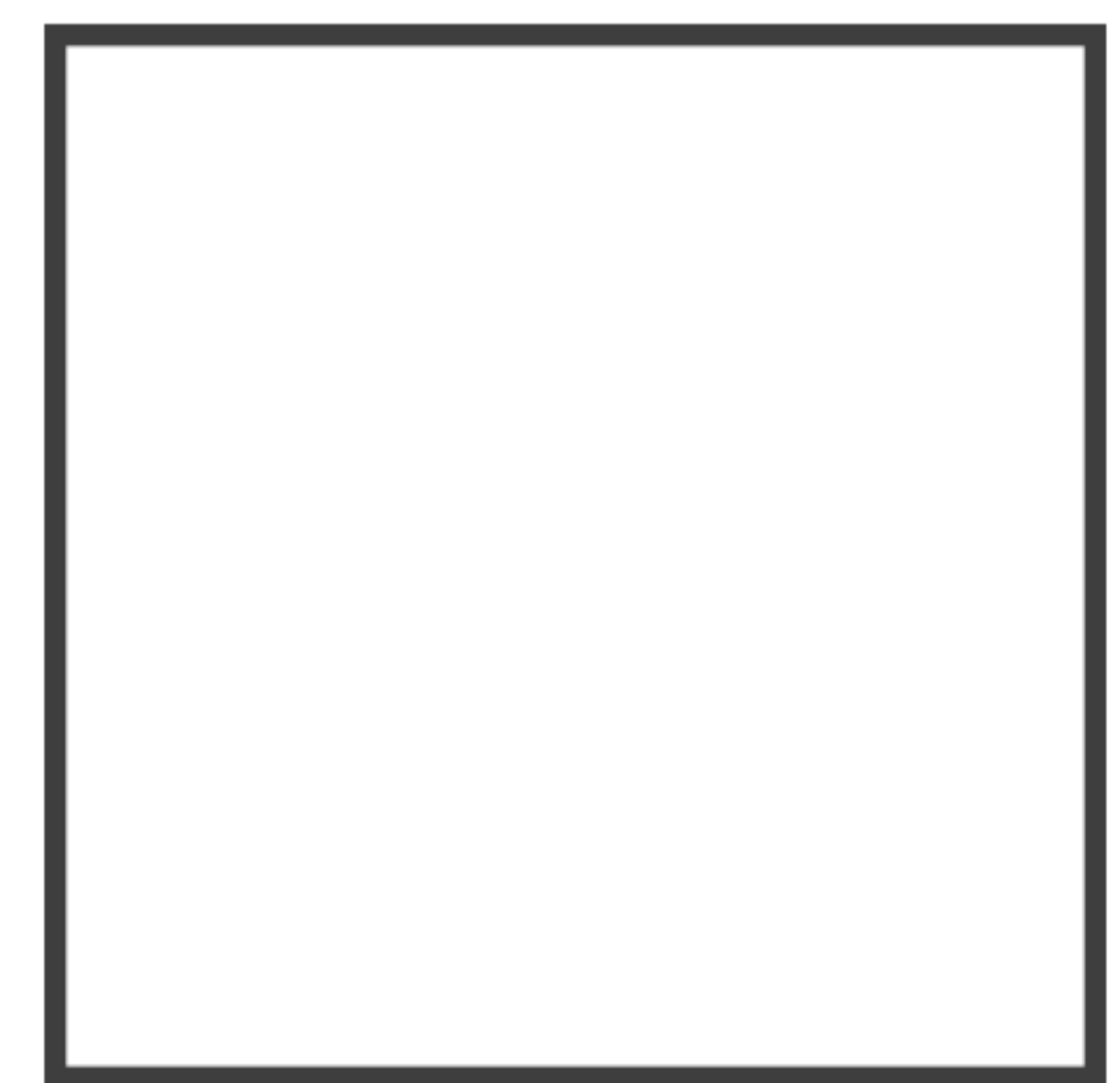
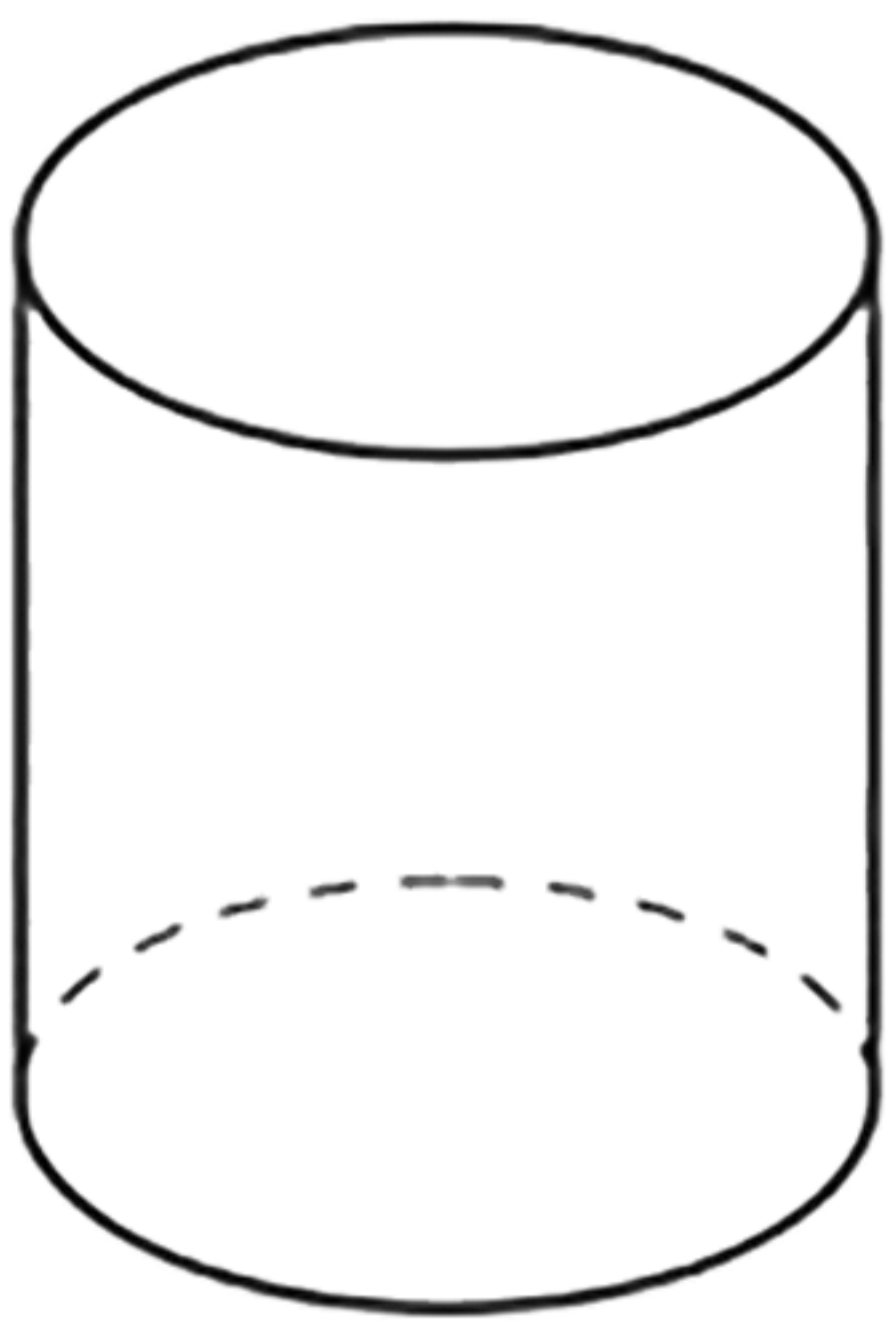

QUADRATO

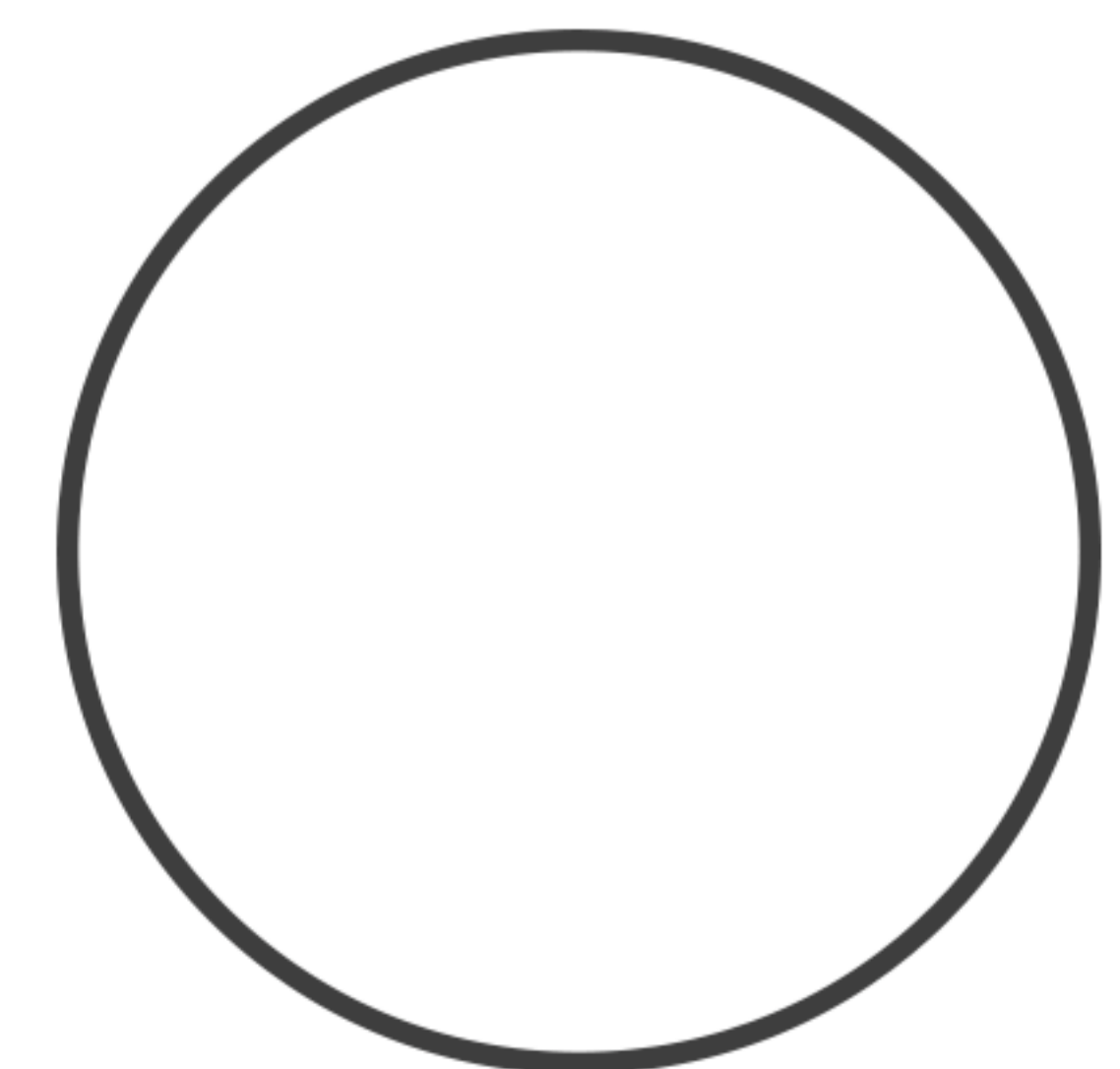
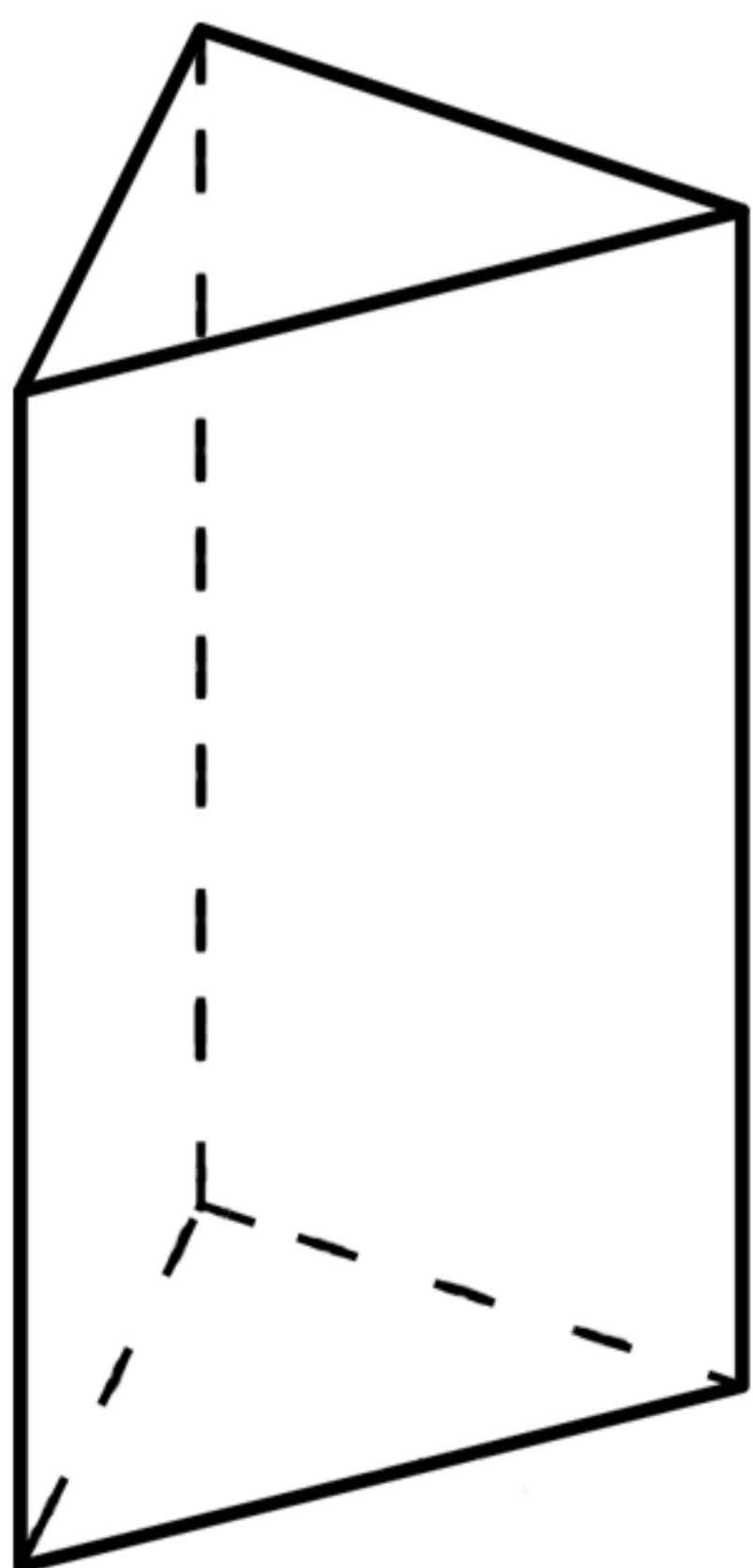

CERCHIO

Forme e figure

- Colora le forme come indicato, poi contale e scrivi il loro numero.



ROSSO

Numero di
quadrati:



VERDE

Numero di
cerchi:

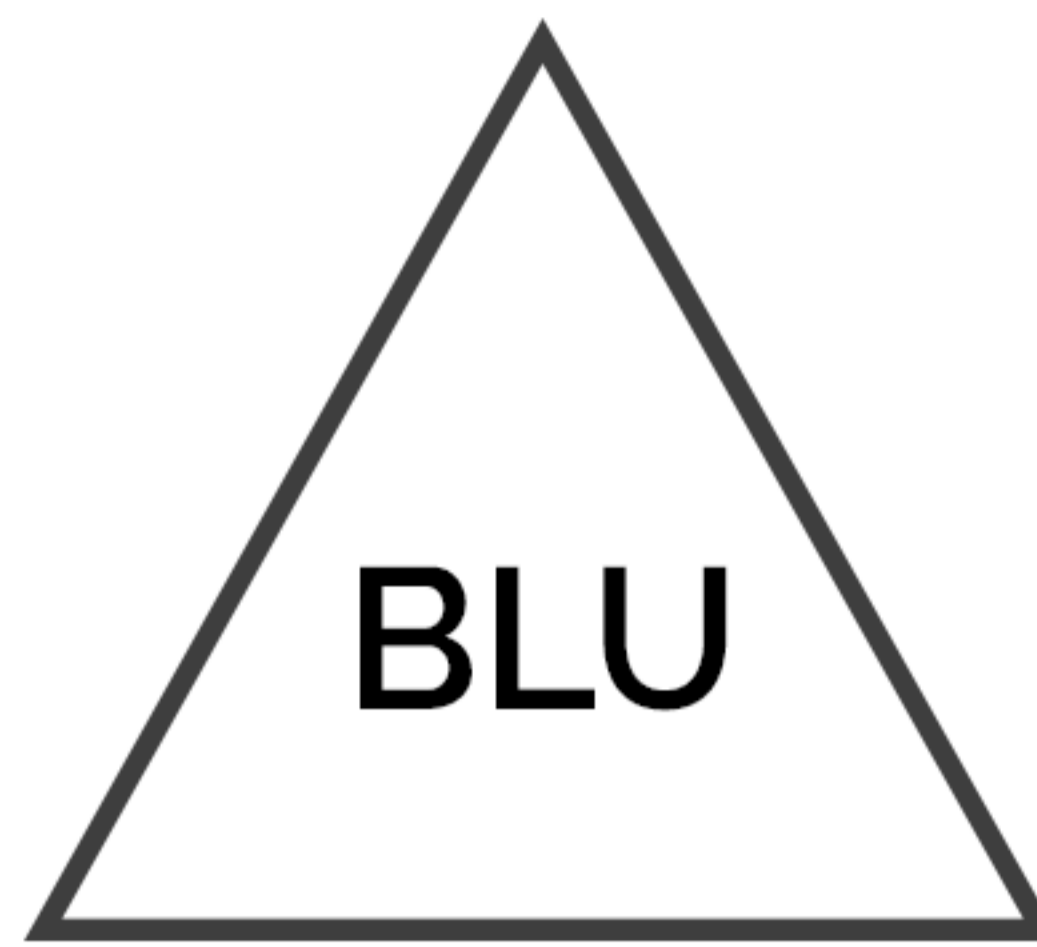

BLU

Numero di
triangoli:



GIALLO

Numero di
rettangoli:

