

# Le frazioni equivalenti

- Nella seconda figura, colora la parte equivalente a quella colorata nella prima, poi scrivi le frazioni, come nel primo esempio.

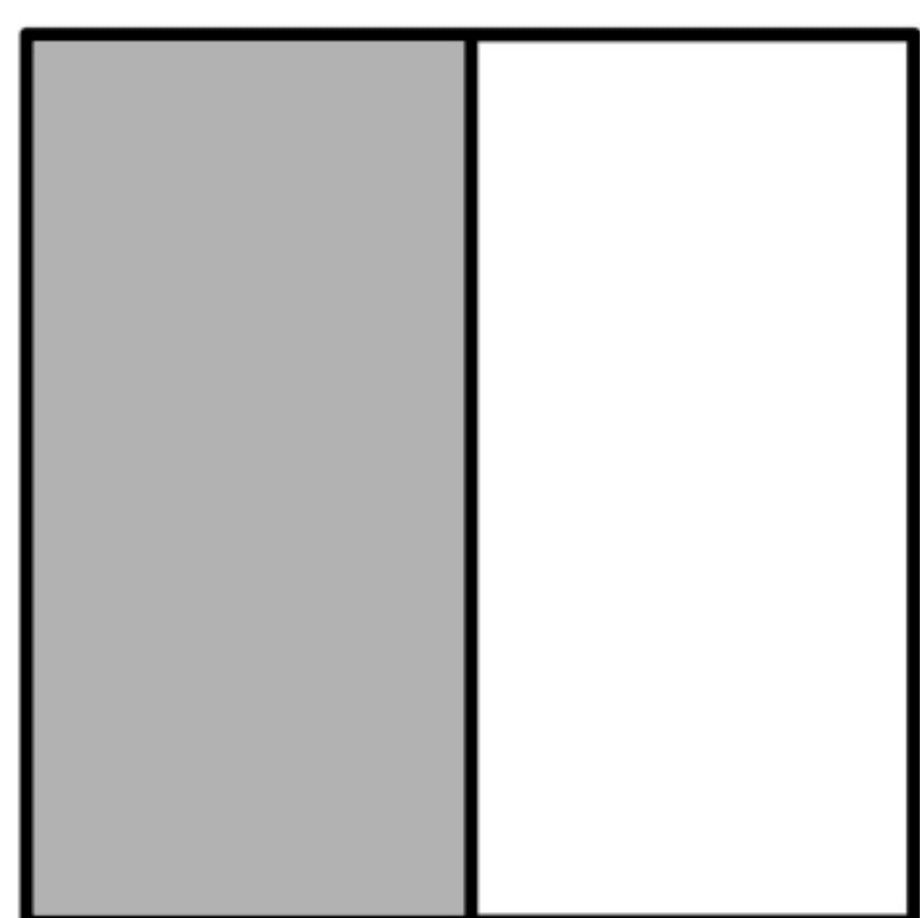

$$\frac{1}{2}$$

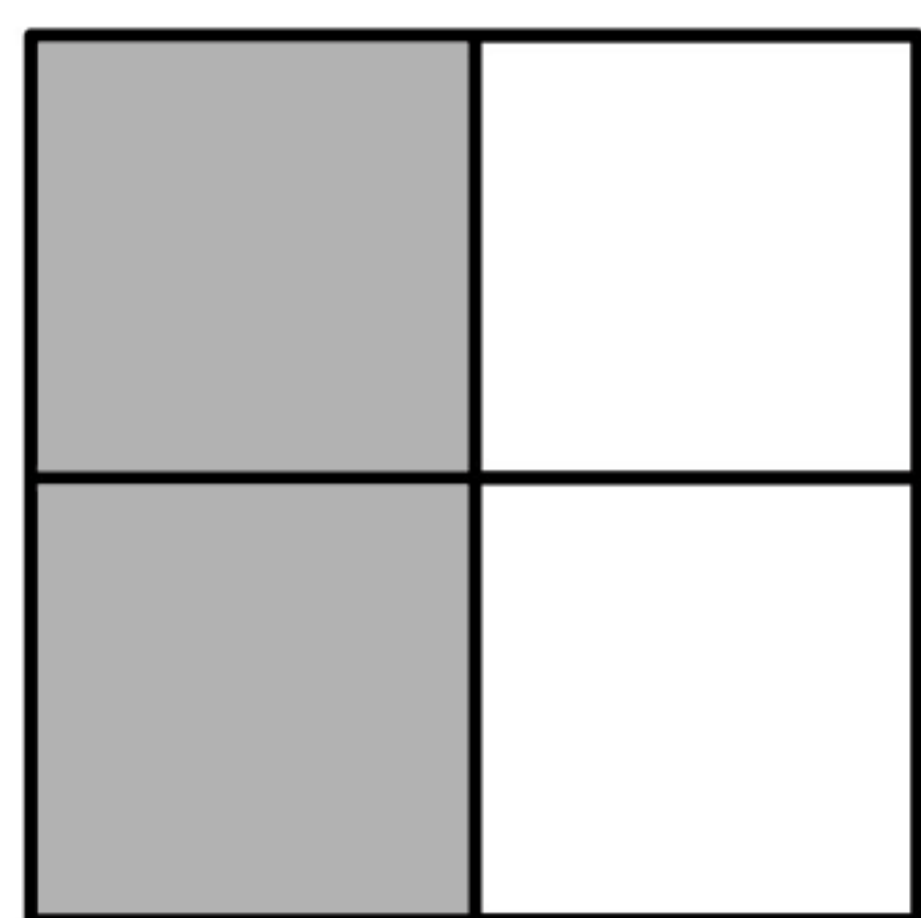

$$\frac{2}{4}$$

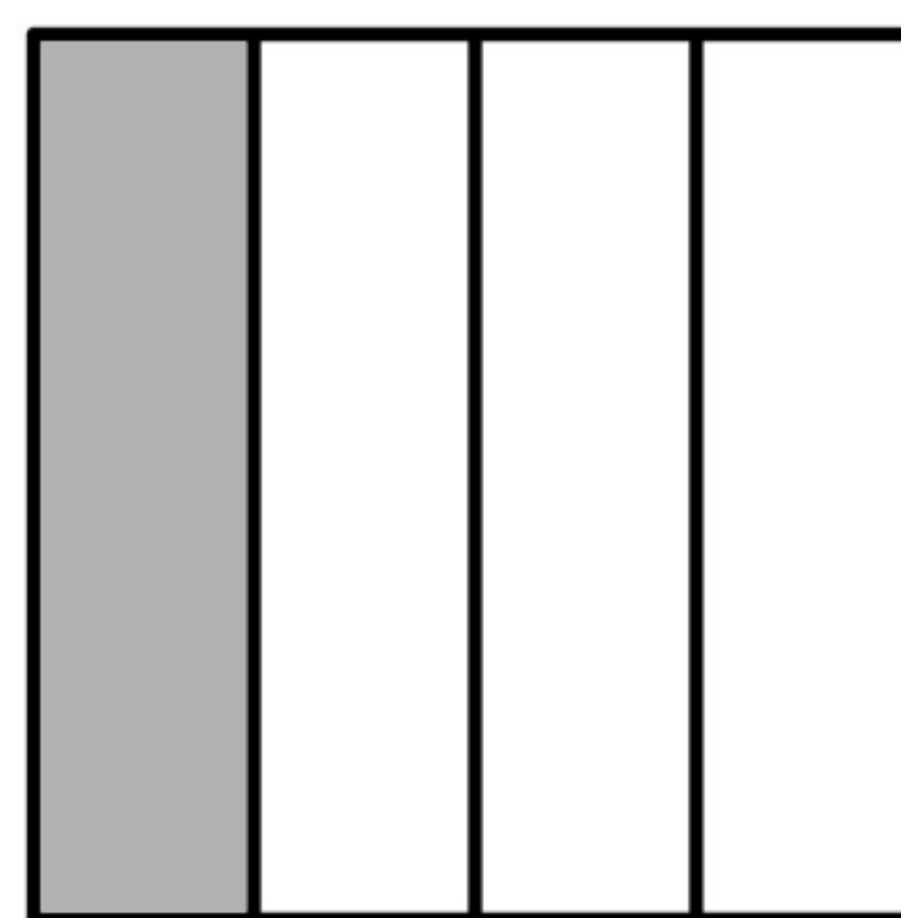

.....  
\_\_\_\_\_

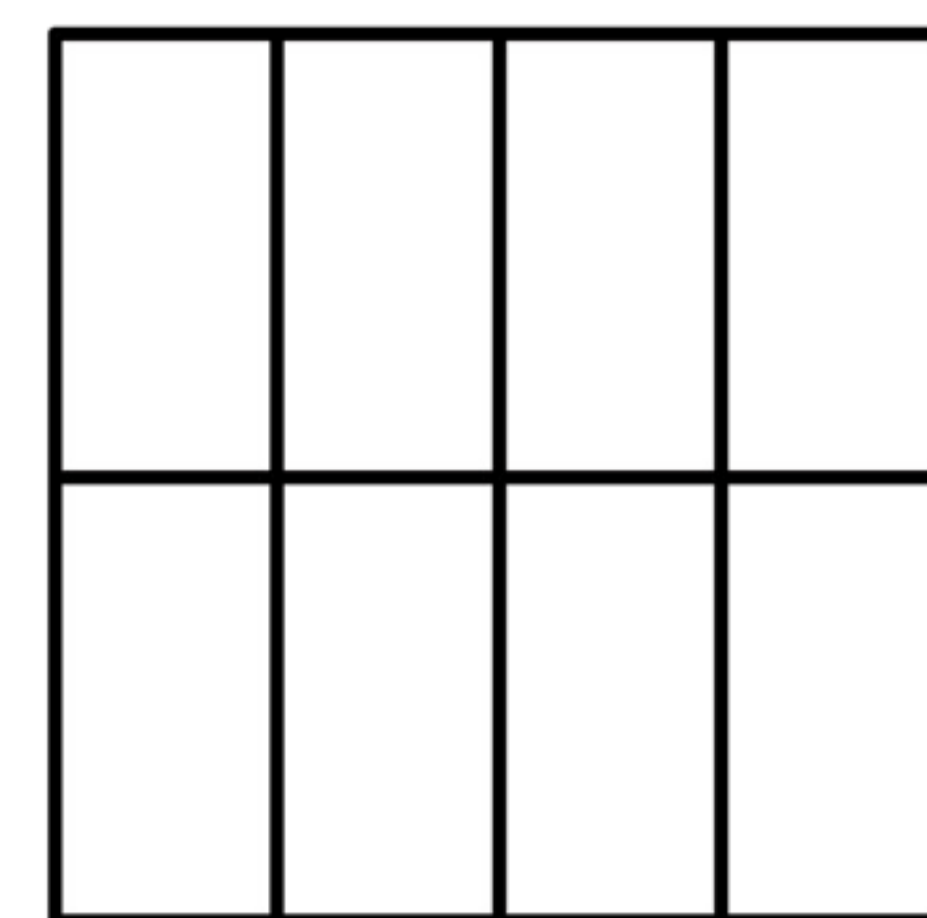

.....  
\_\_\_\_\_

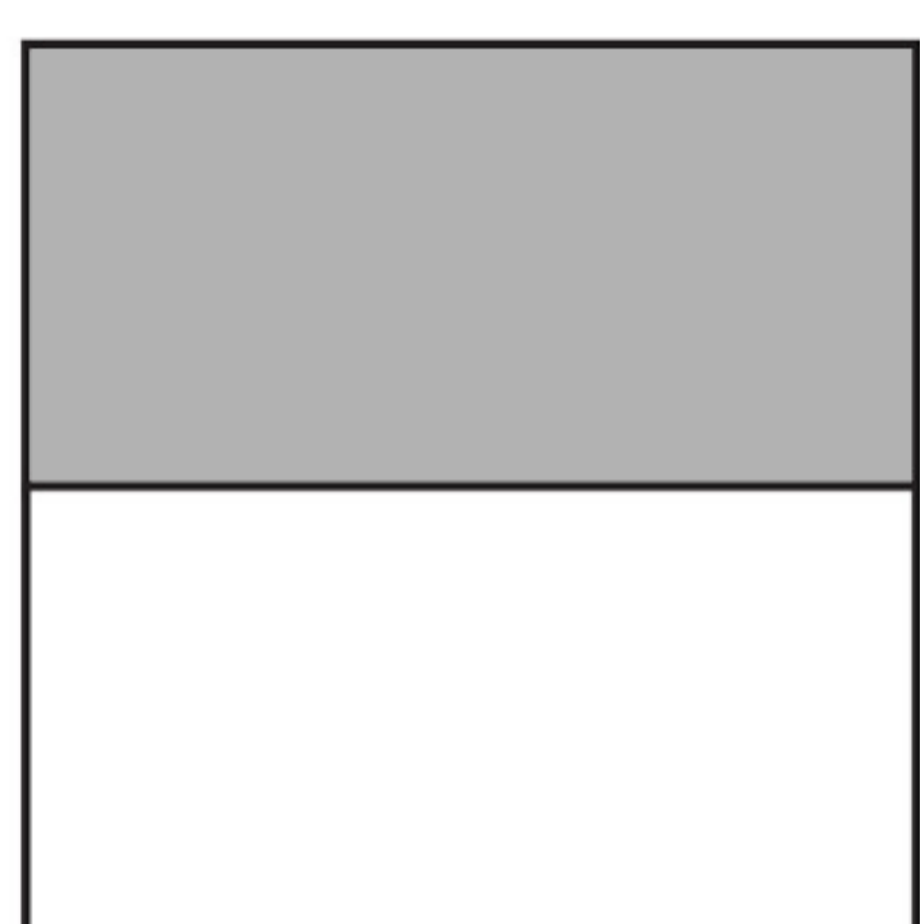

.....  
\_\_\_\_\_

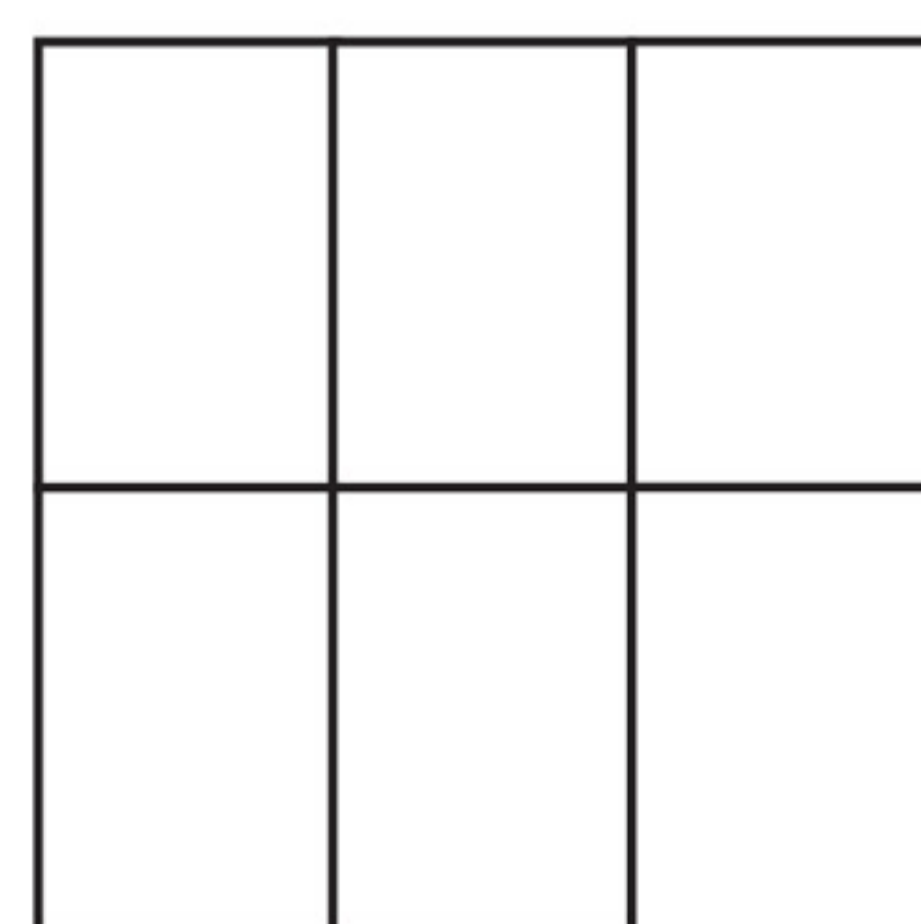

.....  
\_\_\_\_\_

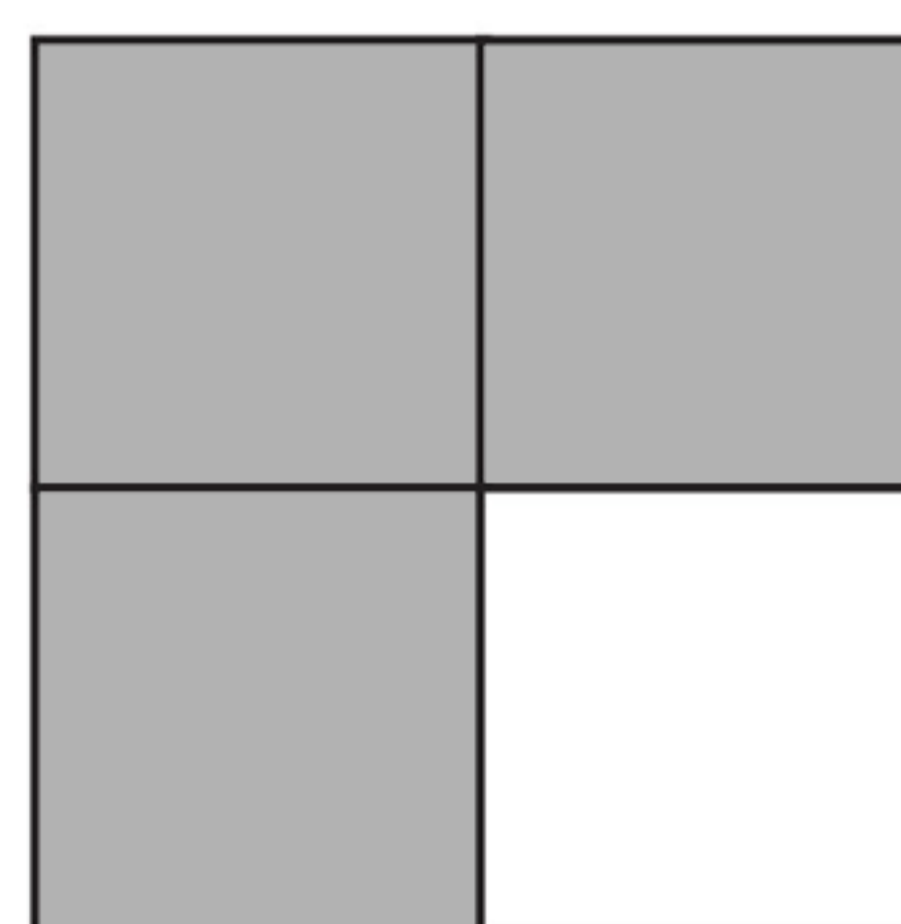

.....  
\_\_\_\_\_

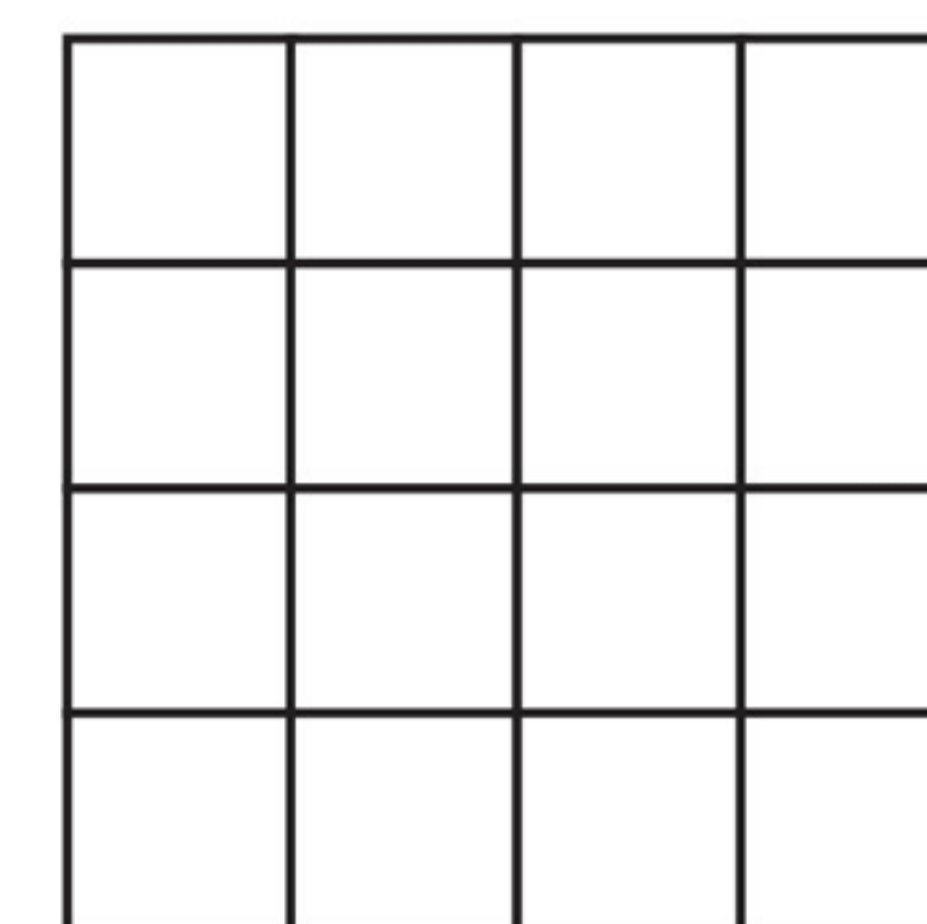

.....  
\_\_\_\_\_

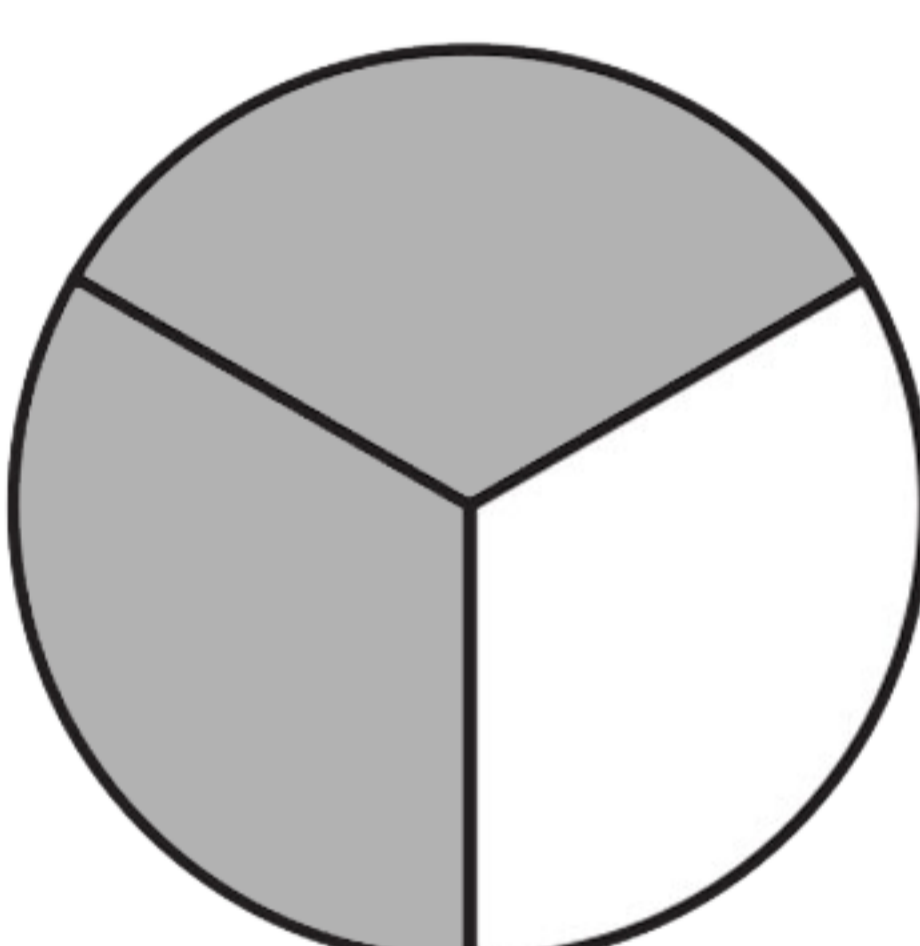

.....  
\_\_\_\_\_

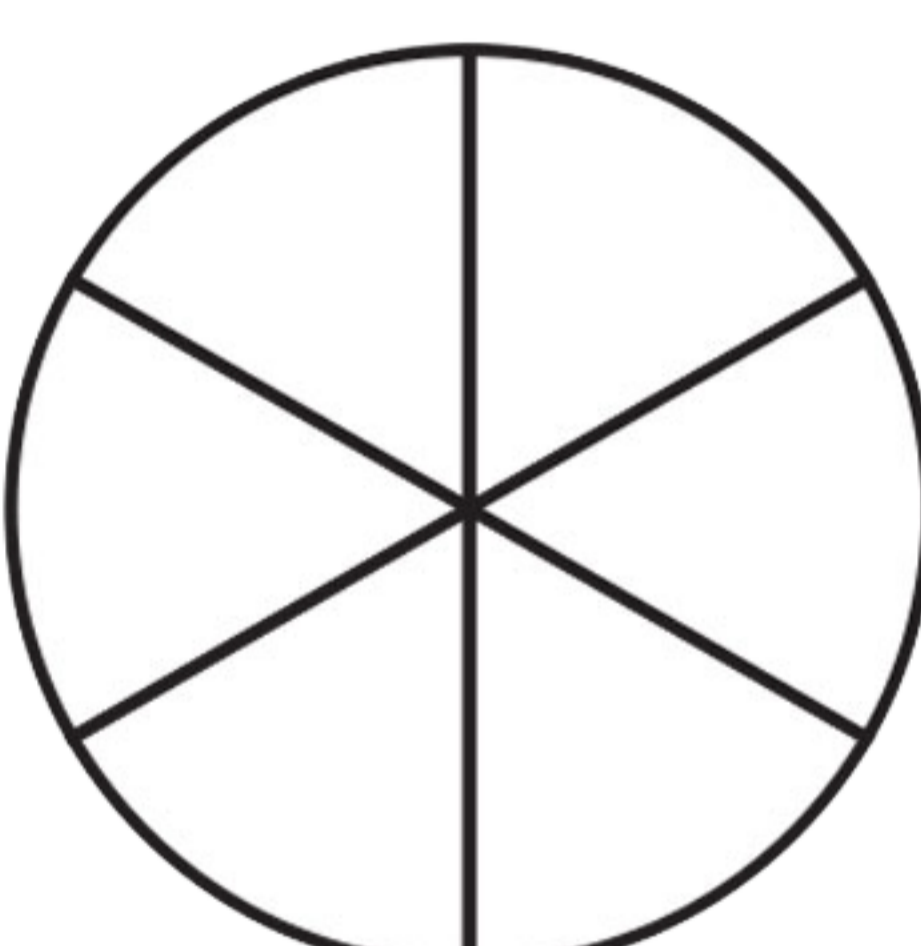

.....  
\_\_\_\_\_

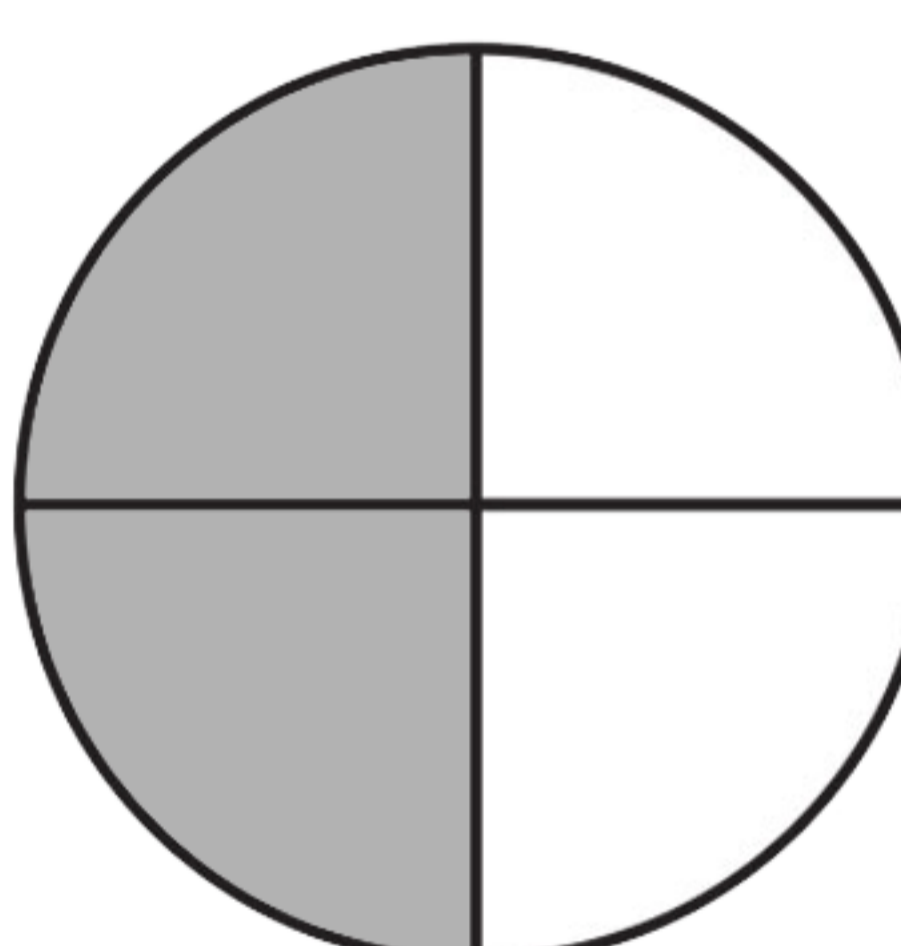

.....  
\_\_\_\_\_

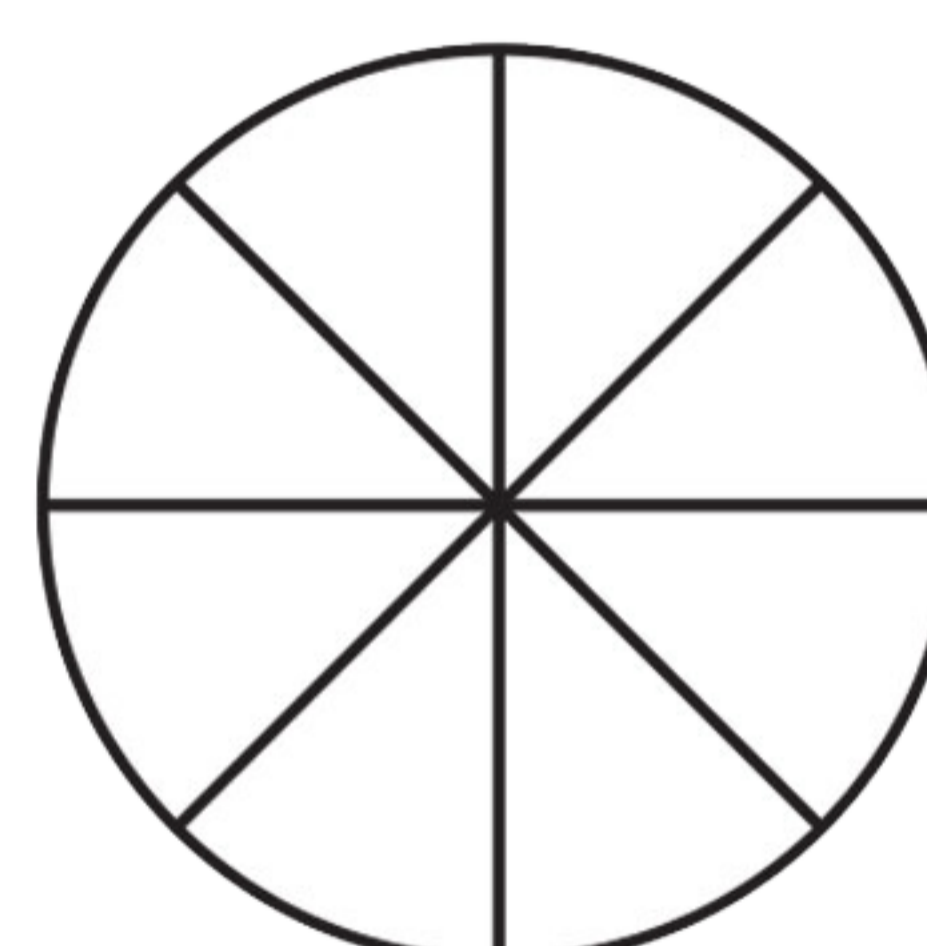

.....  
\_\_\_\_\_

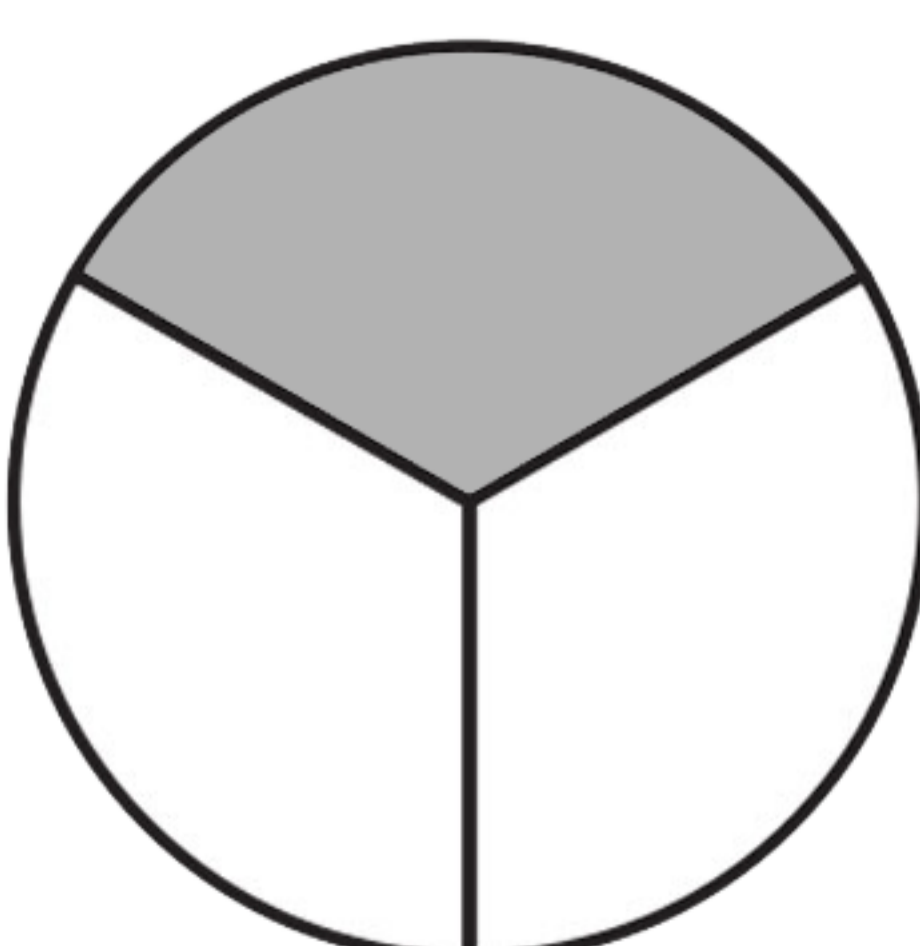

.....  
\_\_\_\_\_

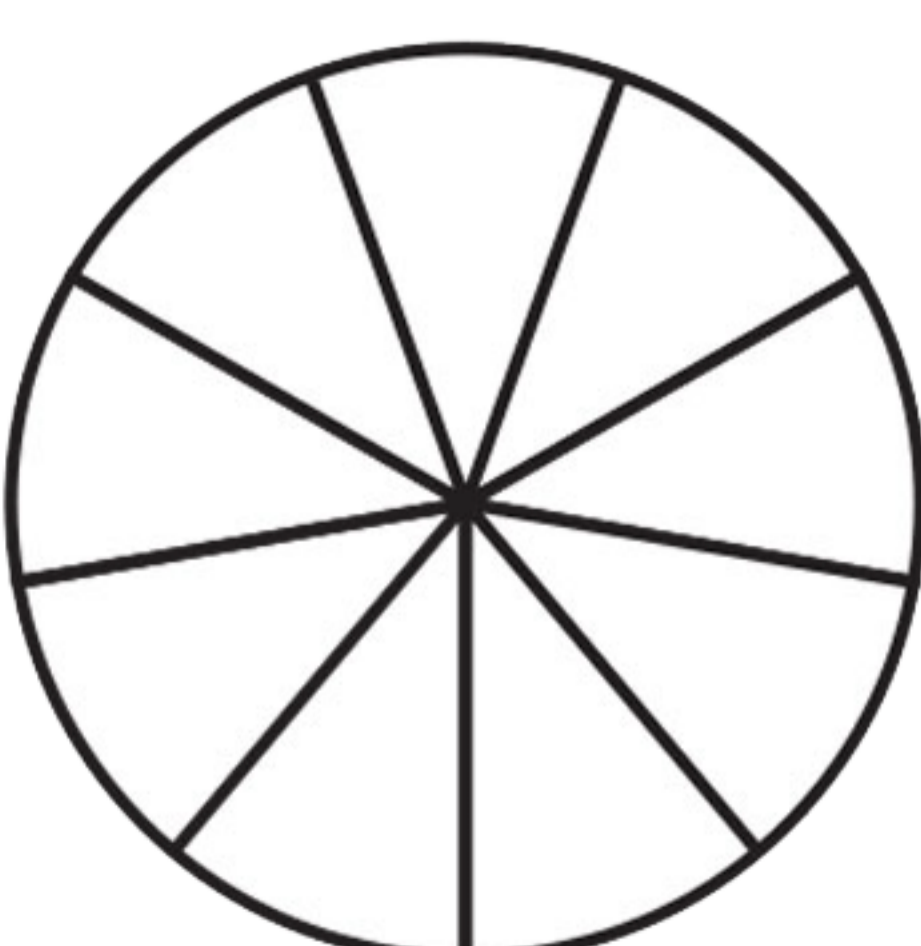

.....  
\_\_\_\_\_

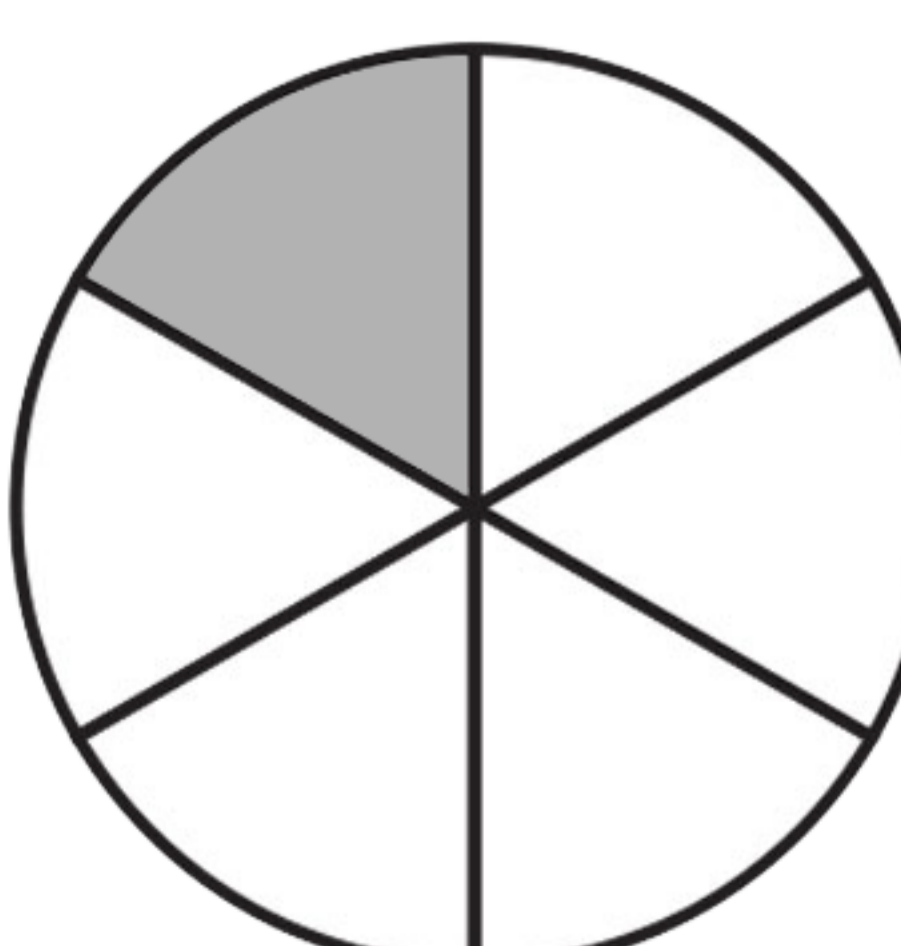

.....  
\_\_\_\_\_

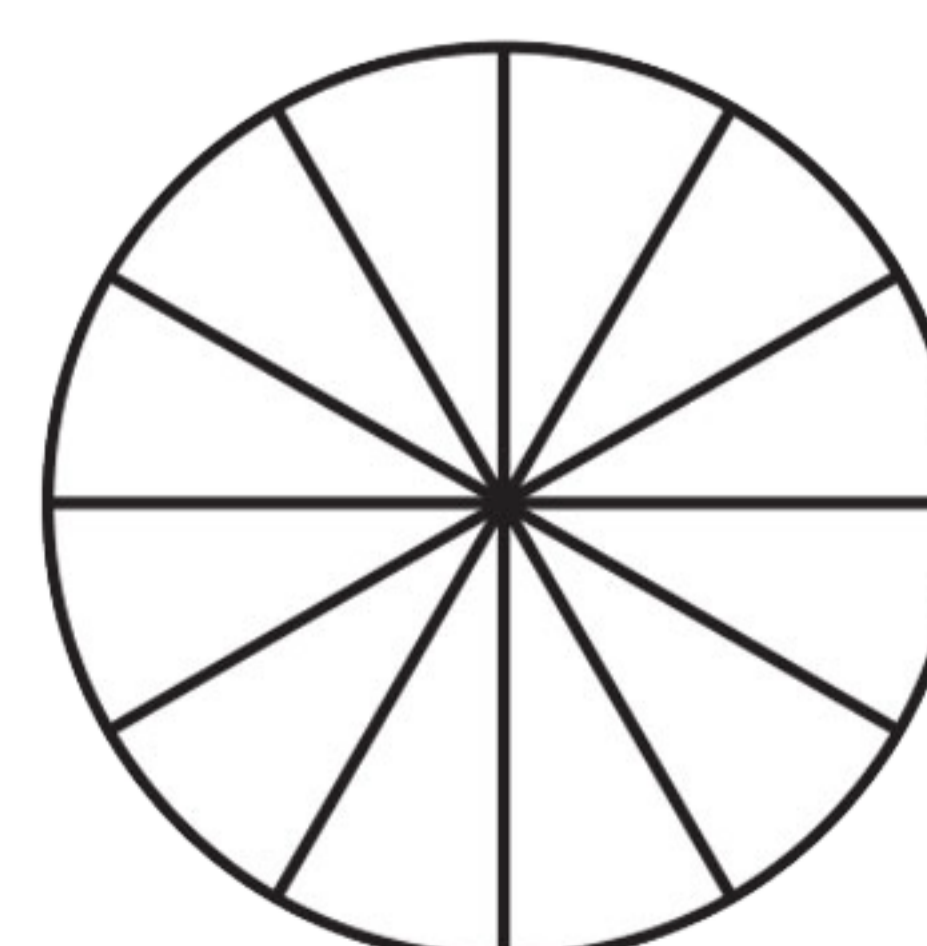

.....  
\_\_\_\_\_

# Le frazioni equivalenti

- Applica la proprietà invariantiva e scopri le frazioni equivalenti.

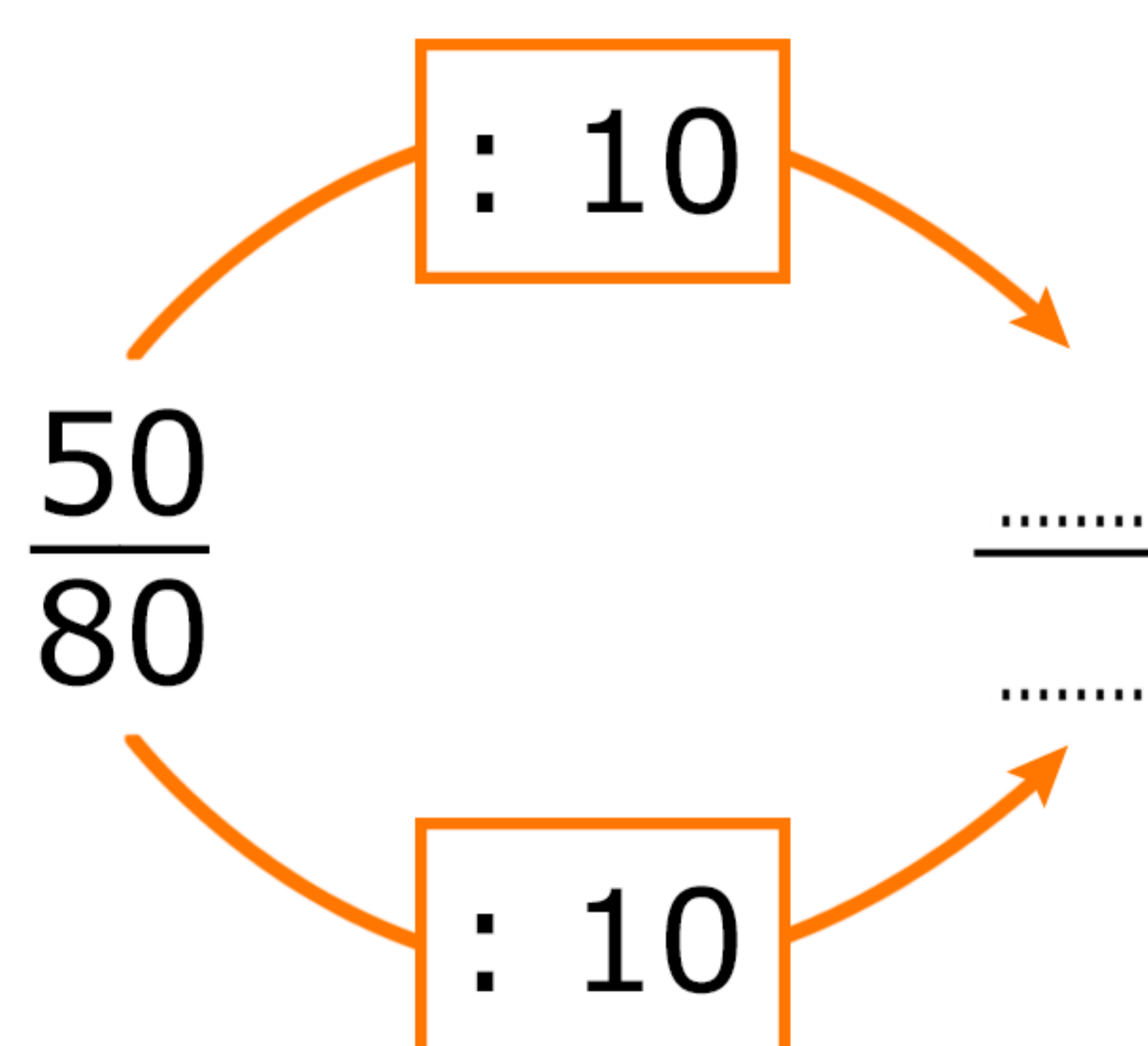
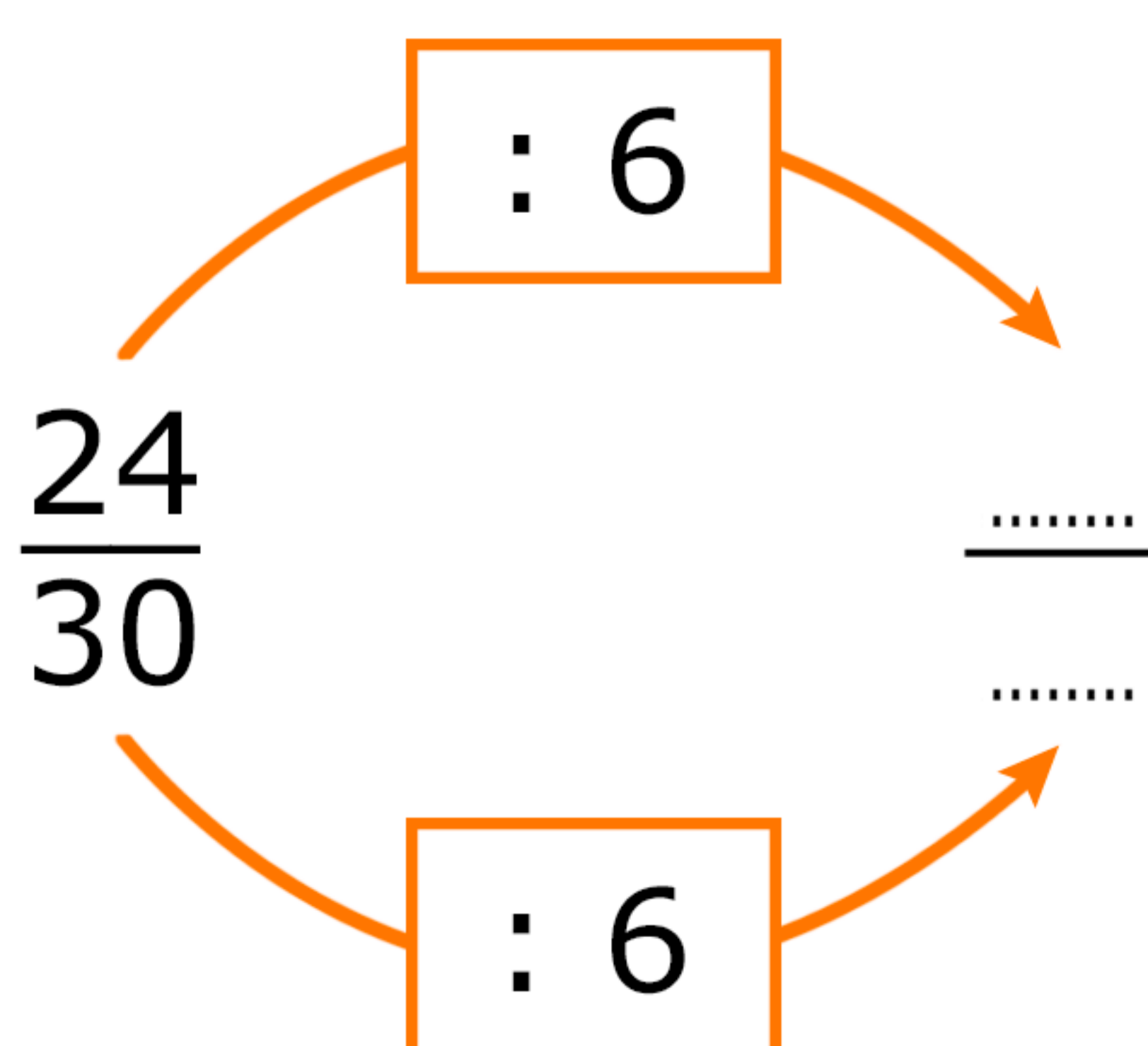
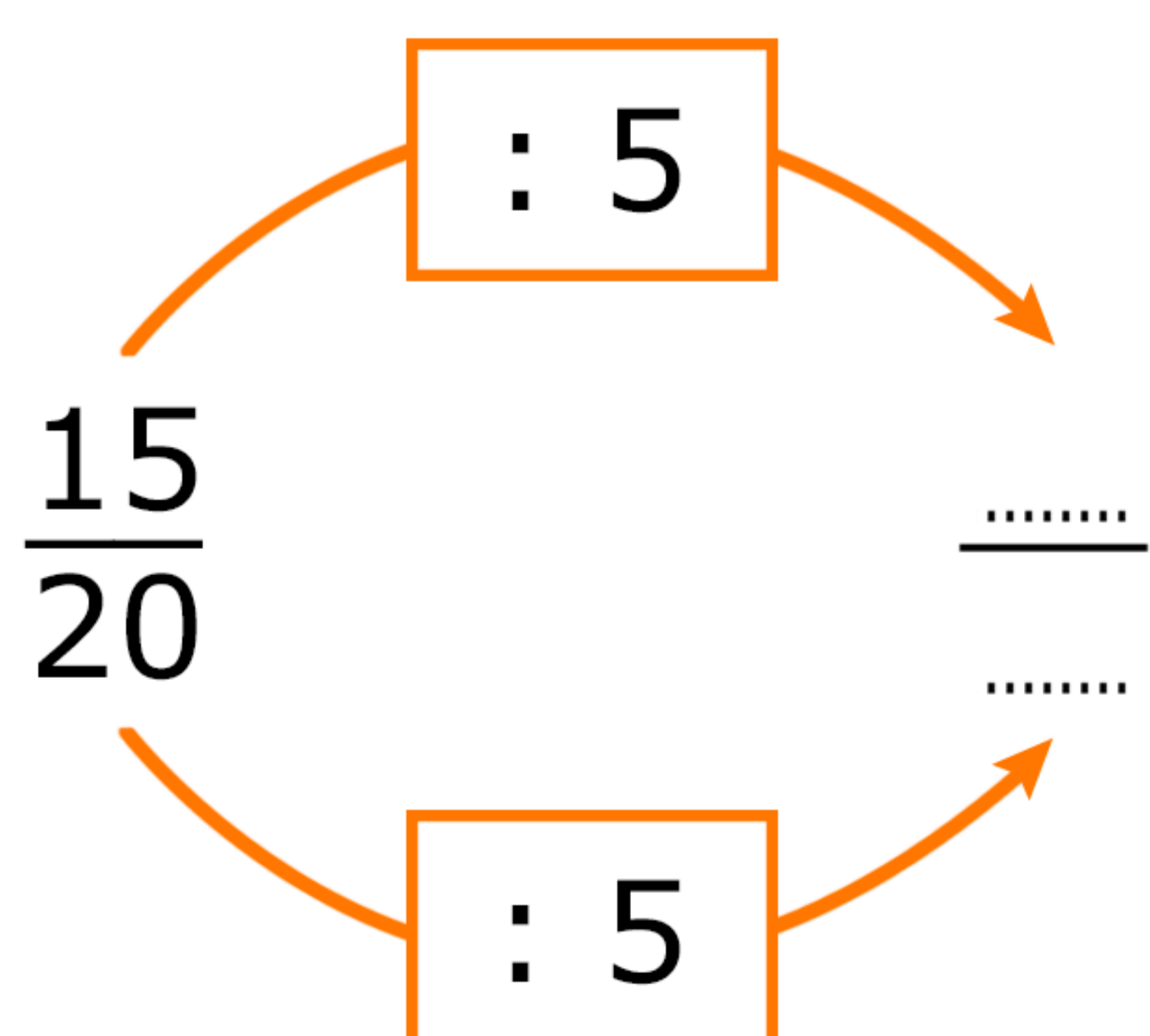
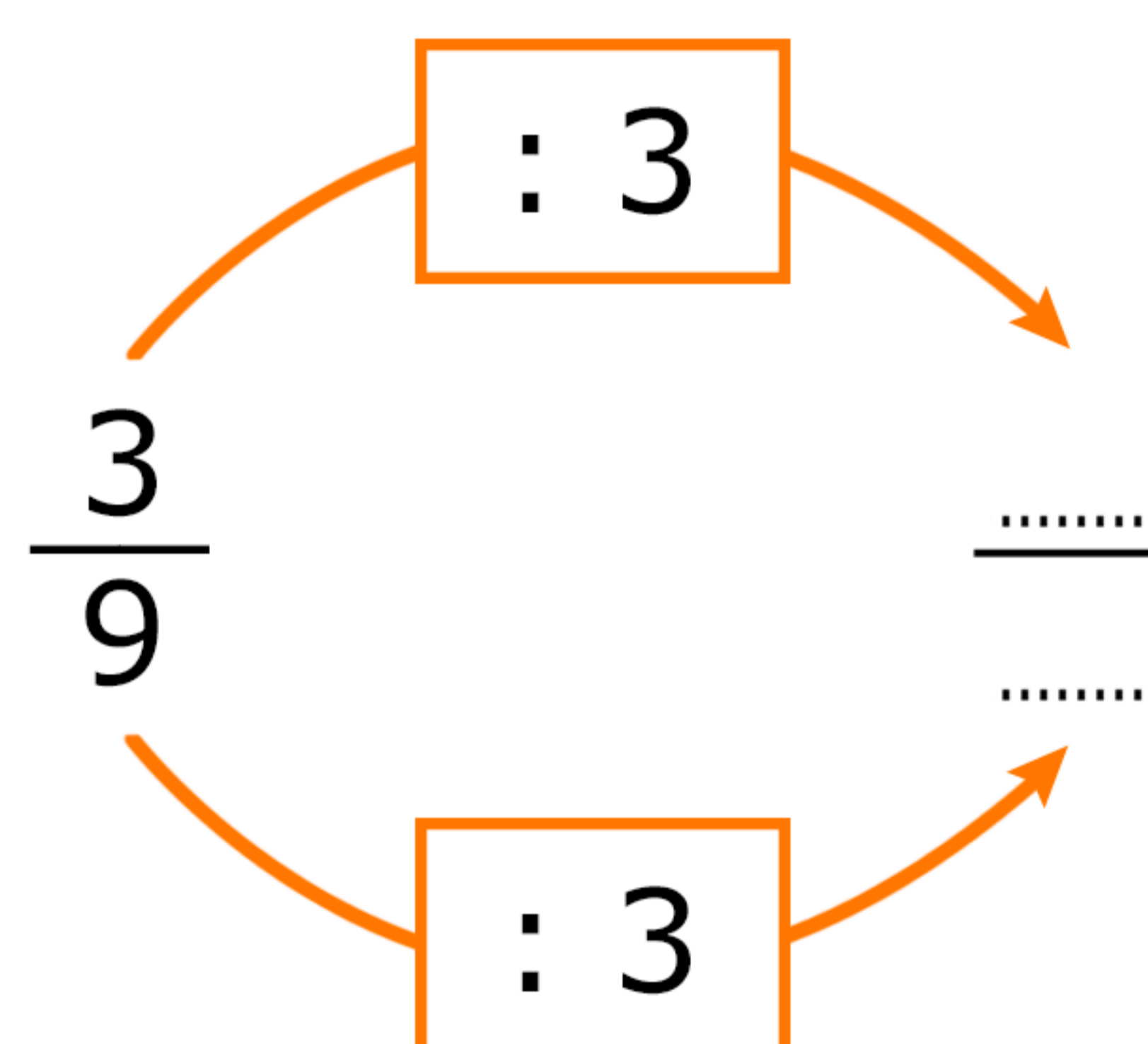
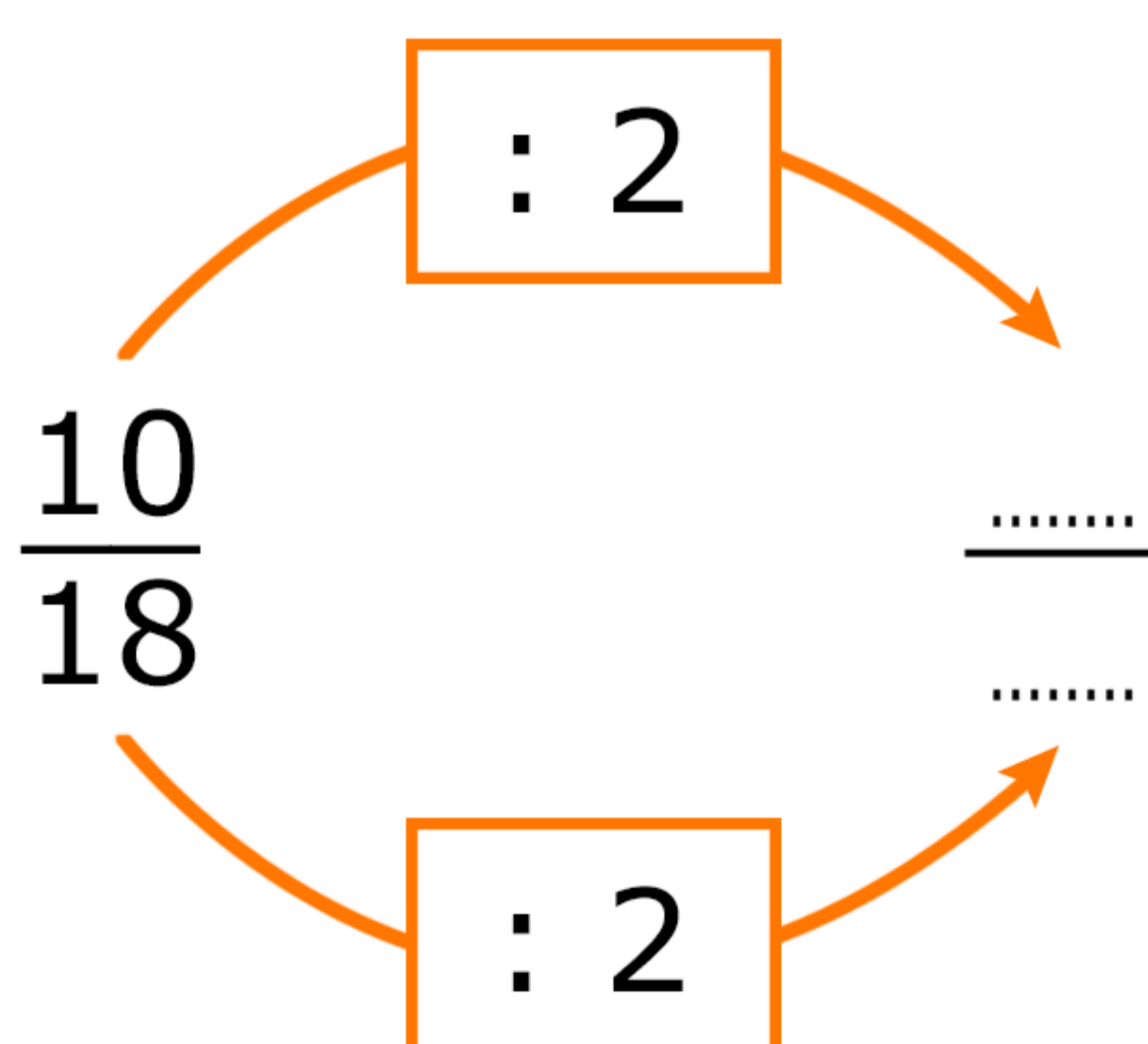
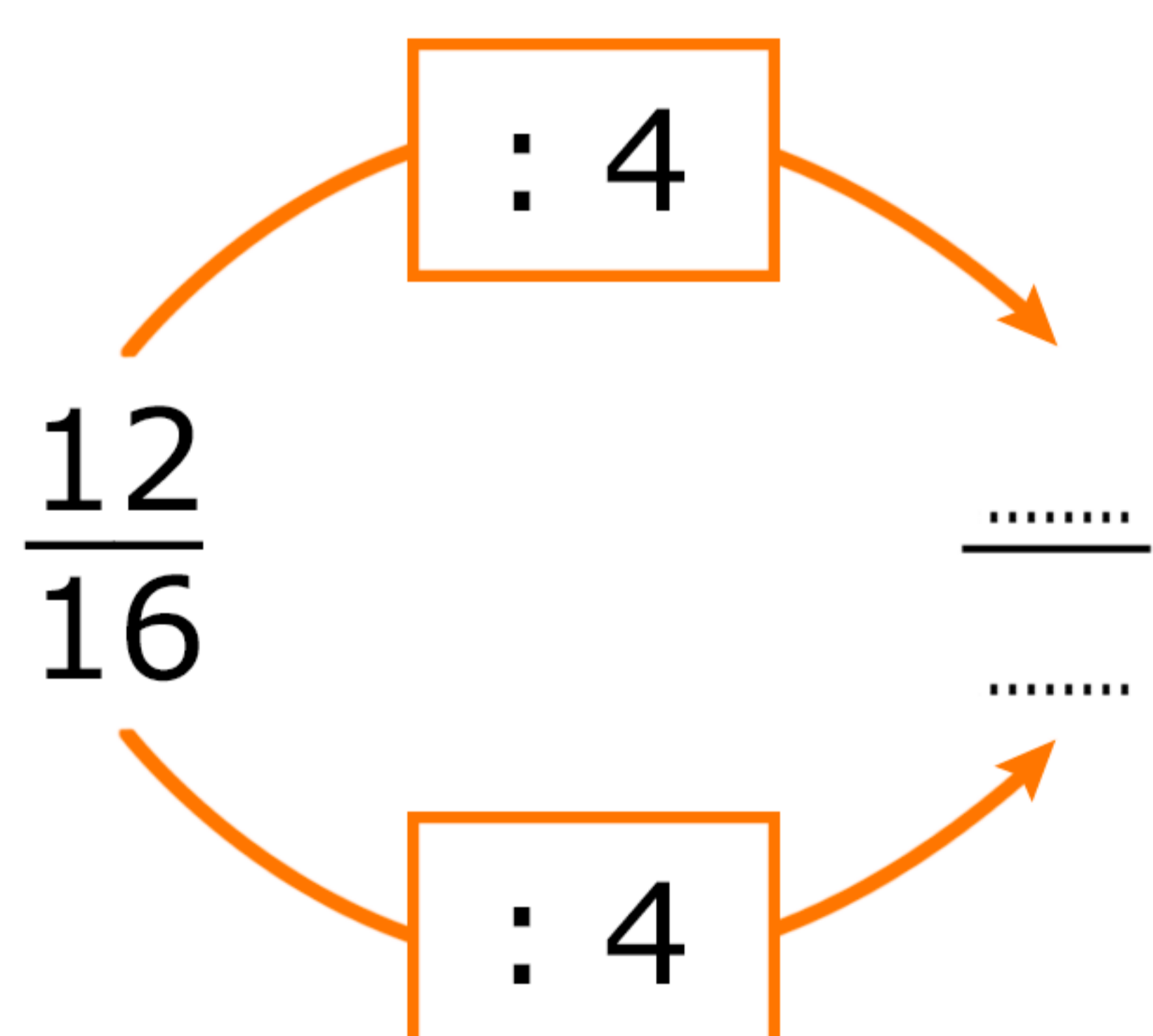
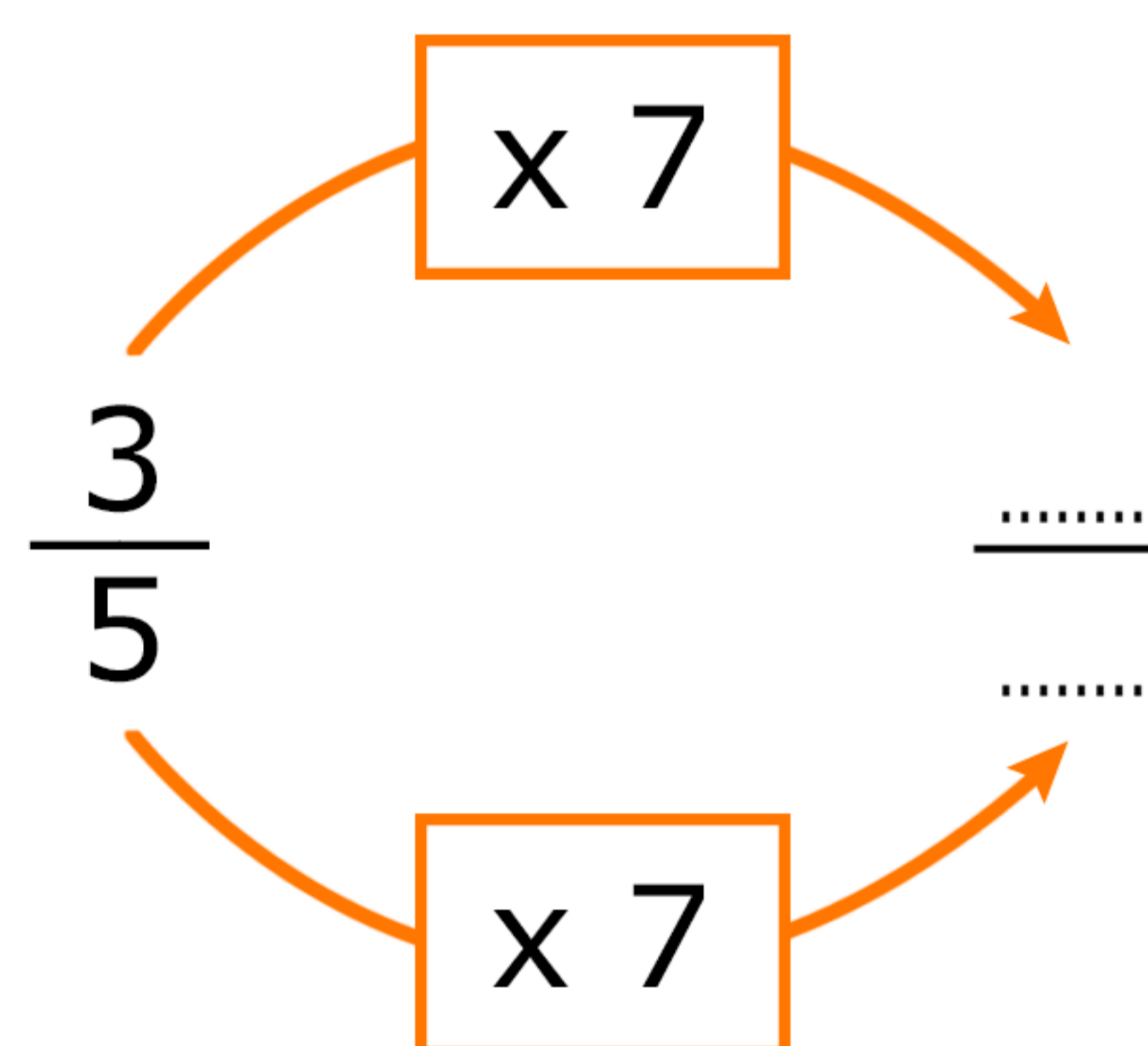
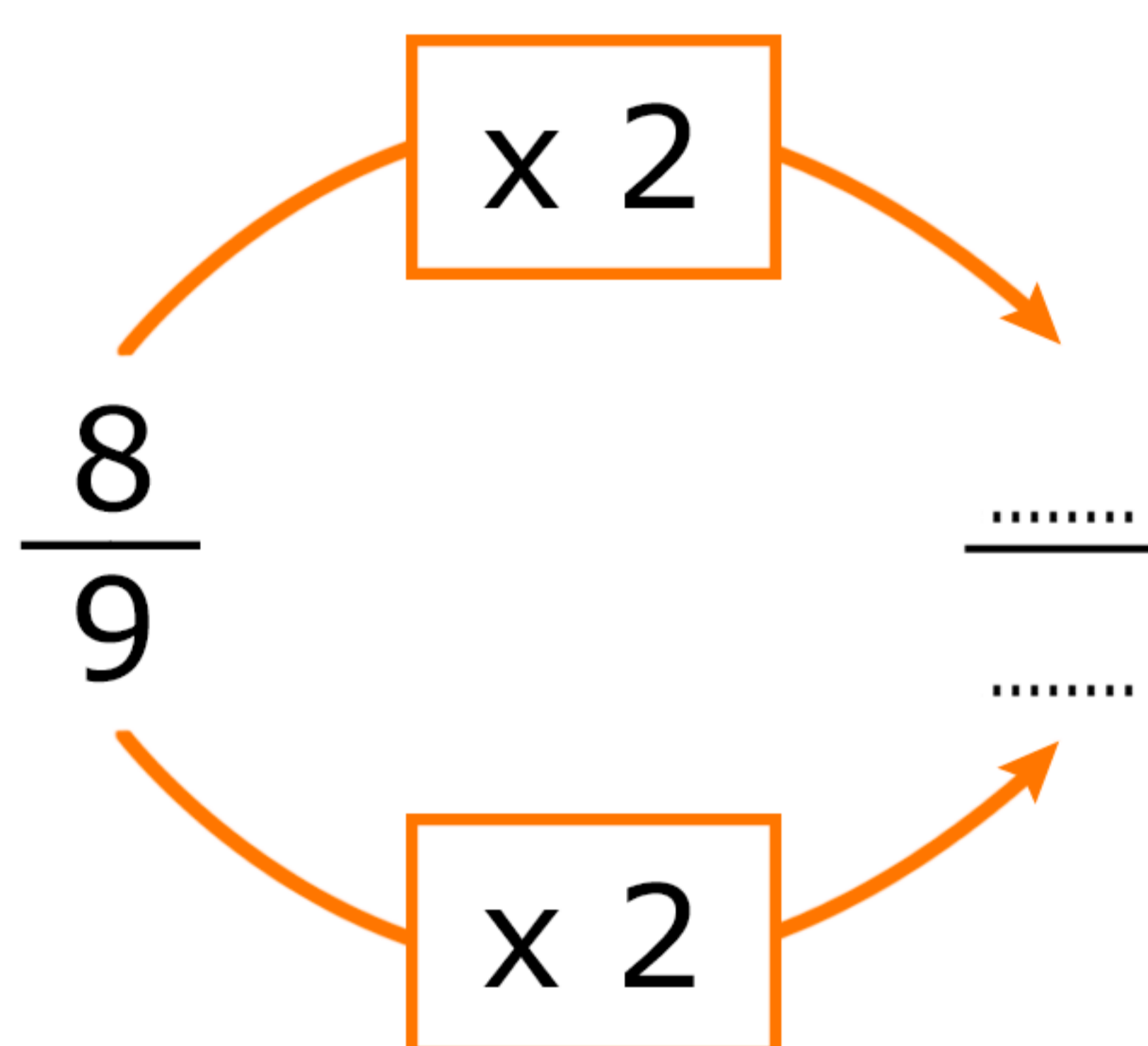
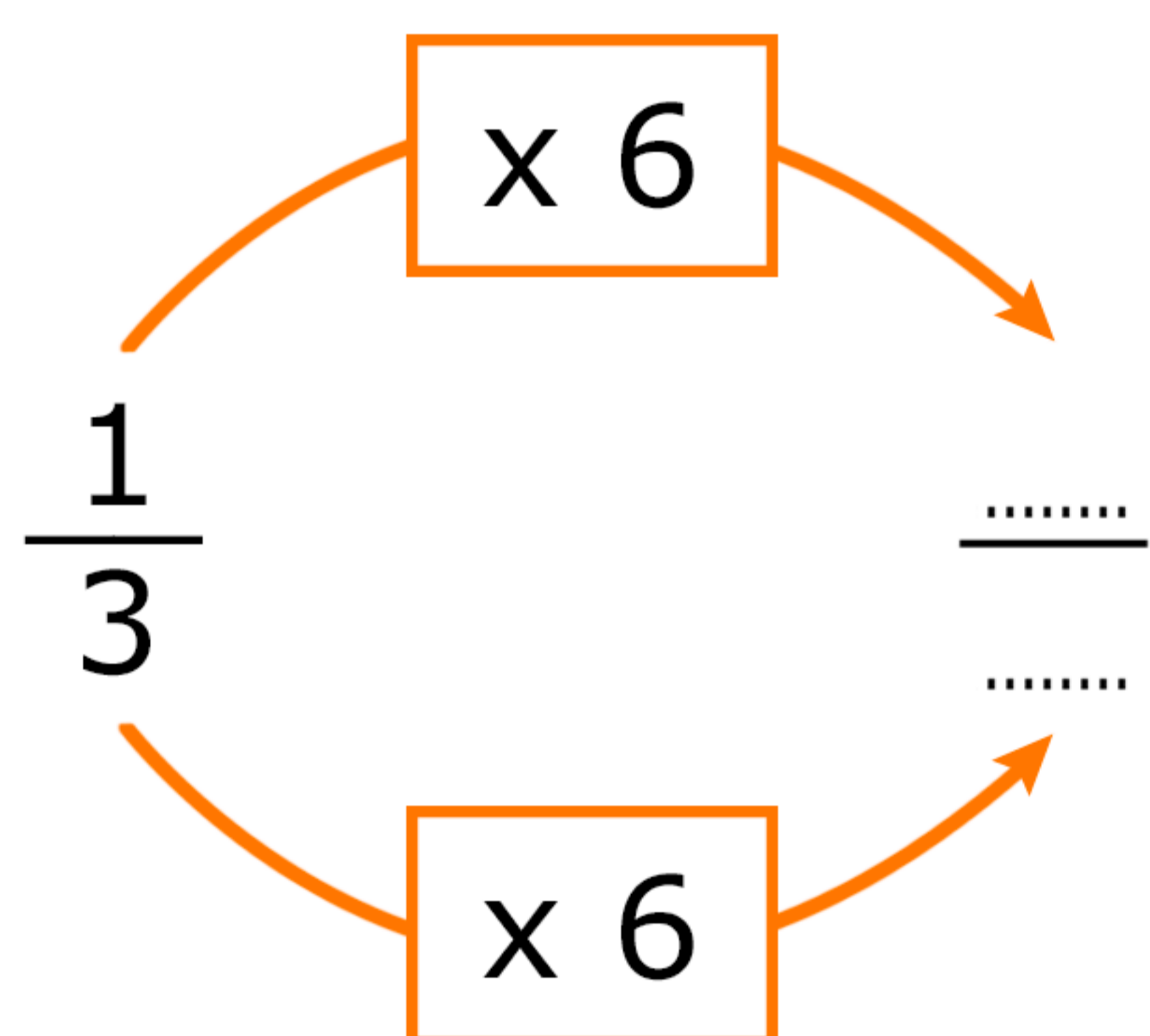
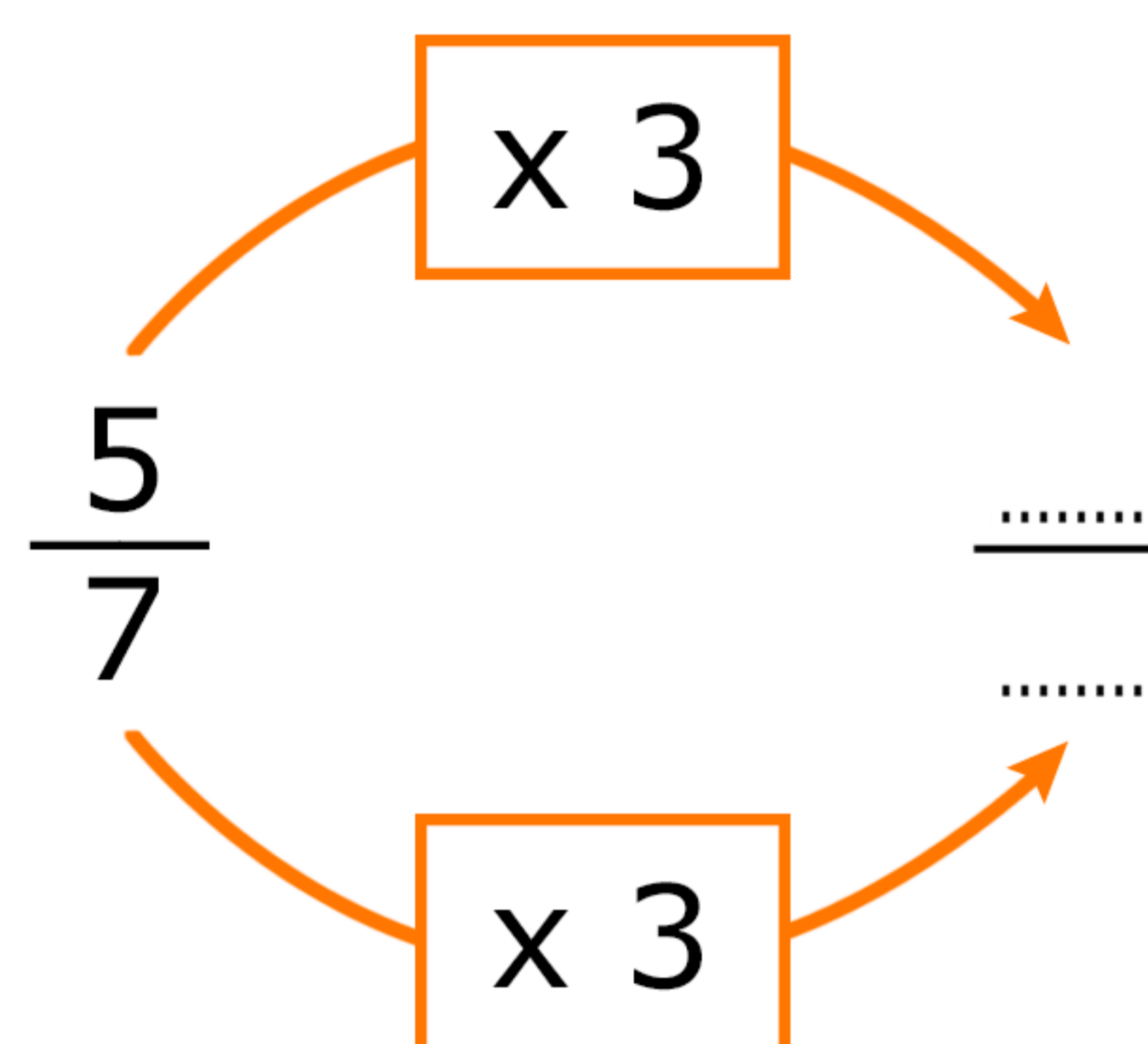
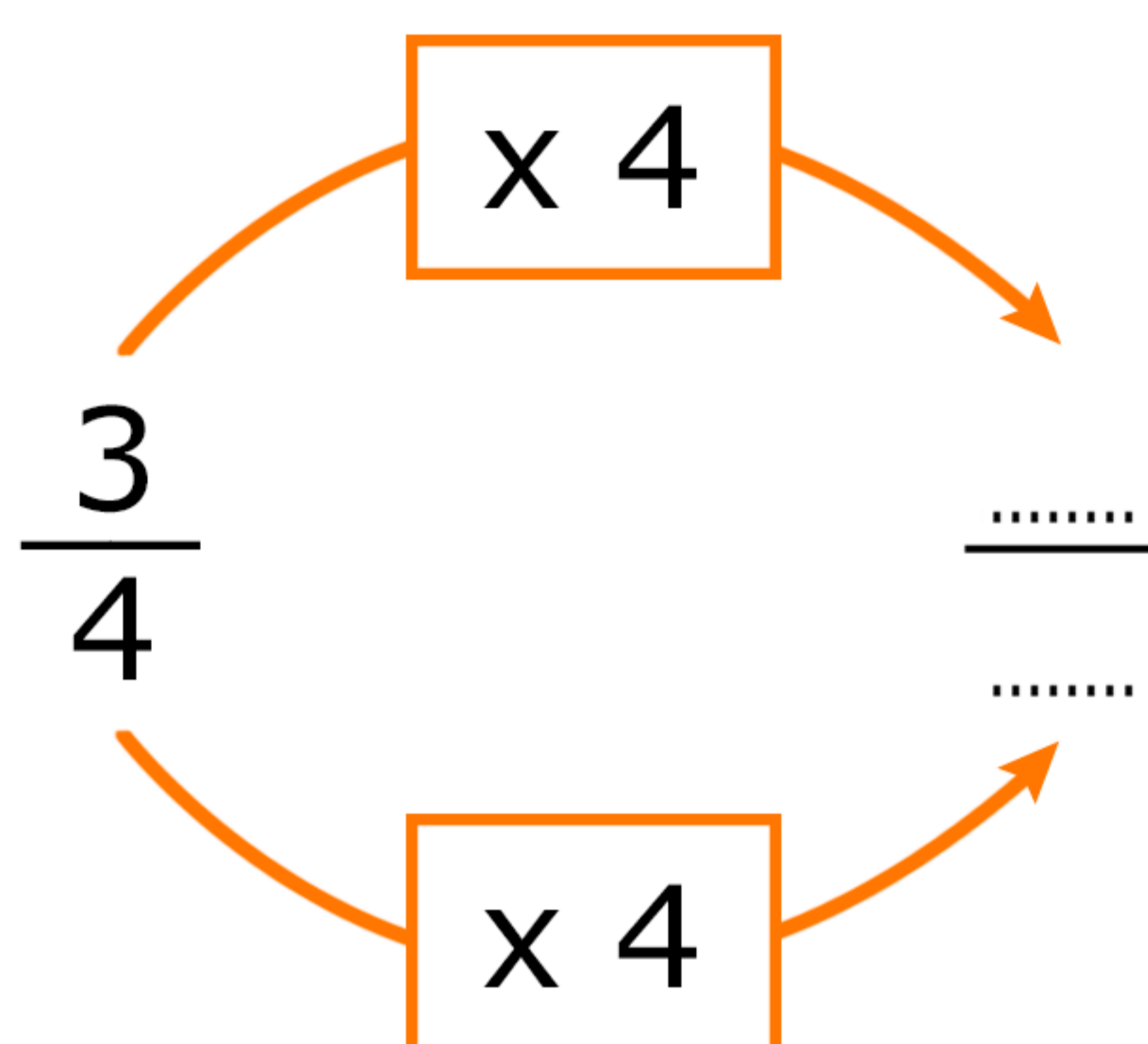
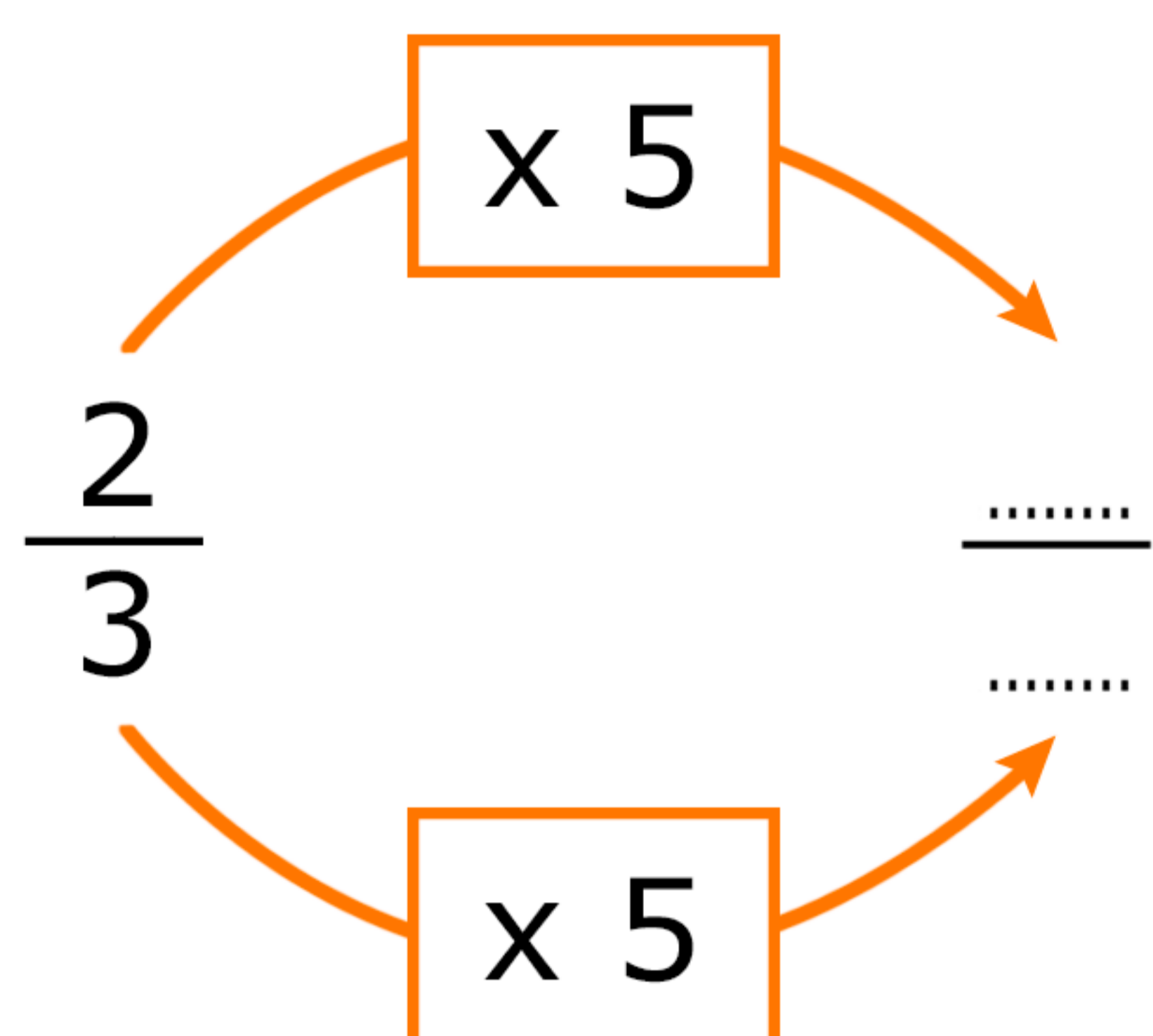



# Le frazioni equivalenti

- Osserva le figure geometriche ed esegui le operazioni per calcolare le frazioni equivalenti a quelle date.

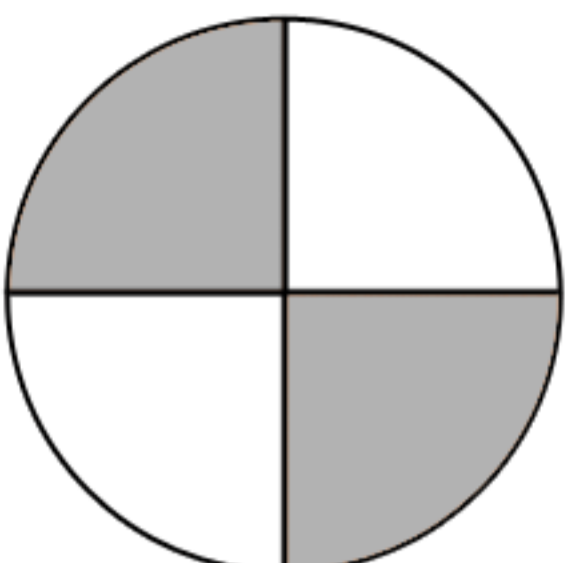
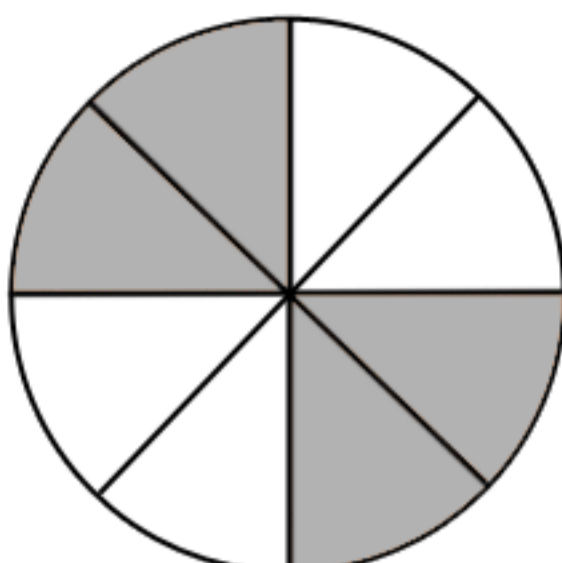
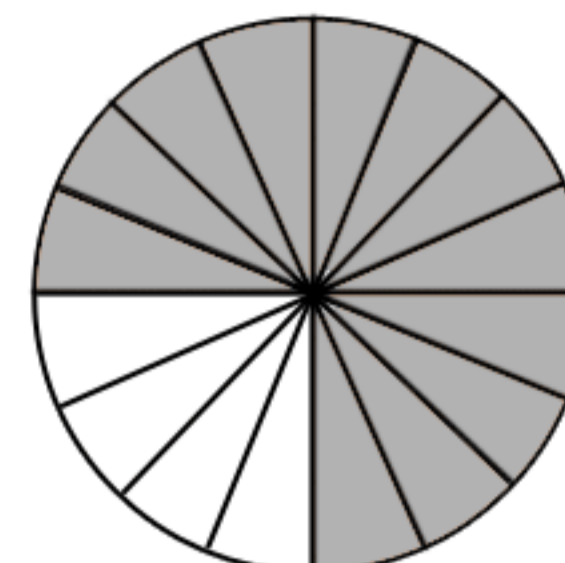
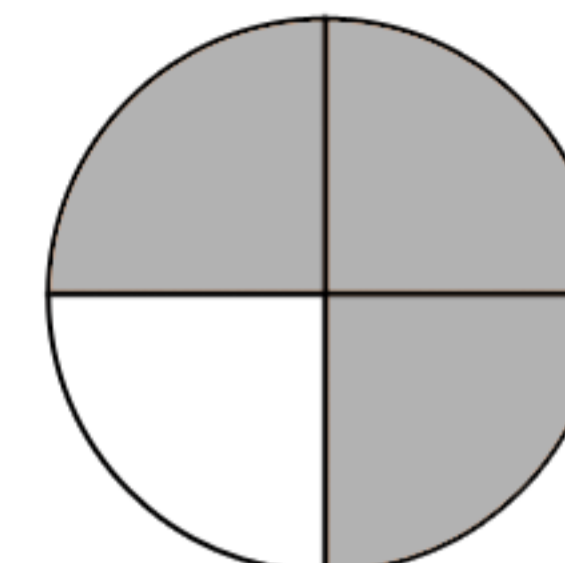
 $\frac{2}{4} \begin{matrix} \rightarrow \times 2 \\ \rightarrow \times 2 \end{matrix} = \frac{\quad}{\quad}$ 	 $\frac{12}{16} \begin{matrix} \rightarrow : 4 \\ \rightarrow : 4 \end{matrix} = \frac{\quad}{\quad}$ 
La frazione $\frac{2}{4}$ è equivalente a .....	La frazione $\frac{12}{16}$ è equivalente a .....

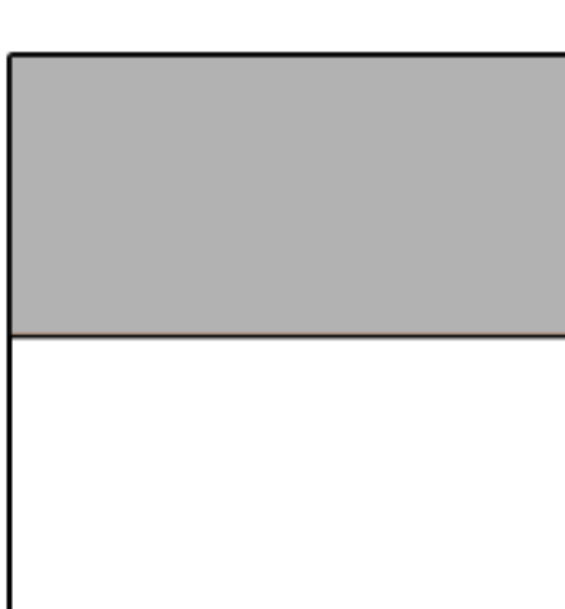
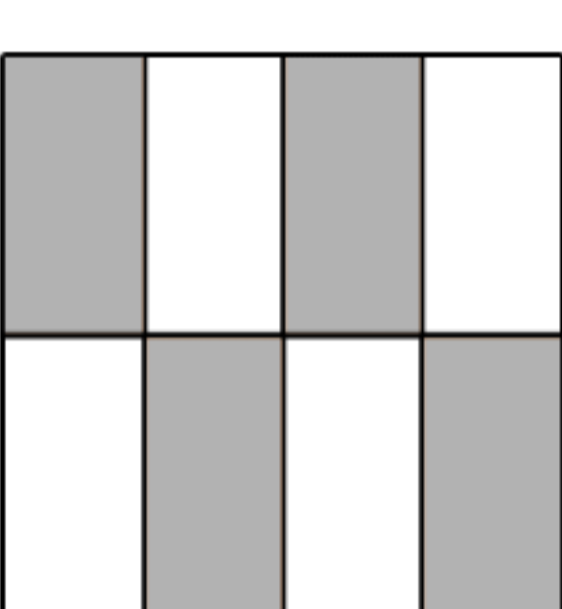
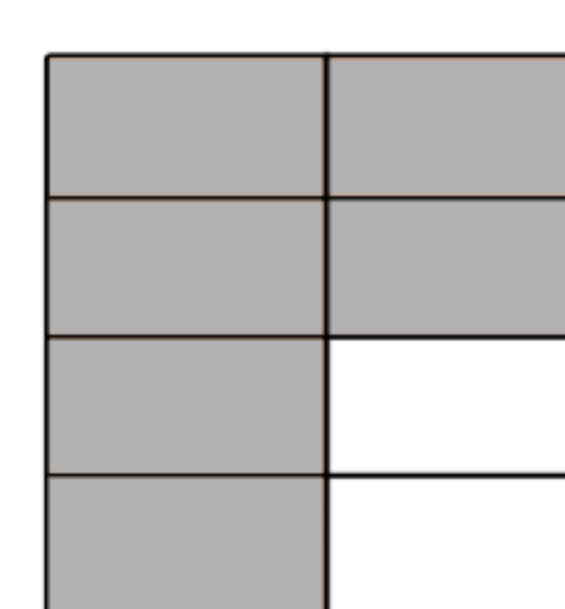
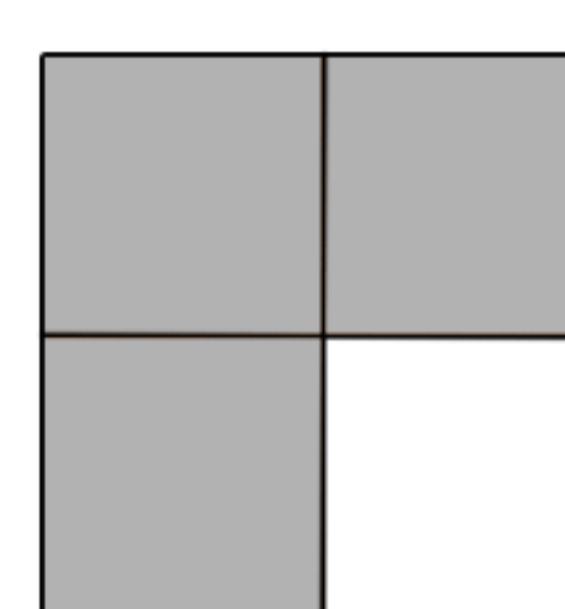
 $\frac{1}{2} \begin{matrix} \rightarrow \times 4 \\ \rightarrow \times 4 \end{matrix} = \frac{\quad}{\quad}$ 	 $\frac{6}{8} \begin{matrix} \rightarrow : 2 \\ \rightarrow : 2 \end{matrix} = \frac{\quad}{\quad}$ 
La frazione $\frac{1}{2}$ è equivalente a .....	La frazione $\frac{6}{8}$ è equivalente a .....

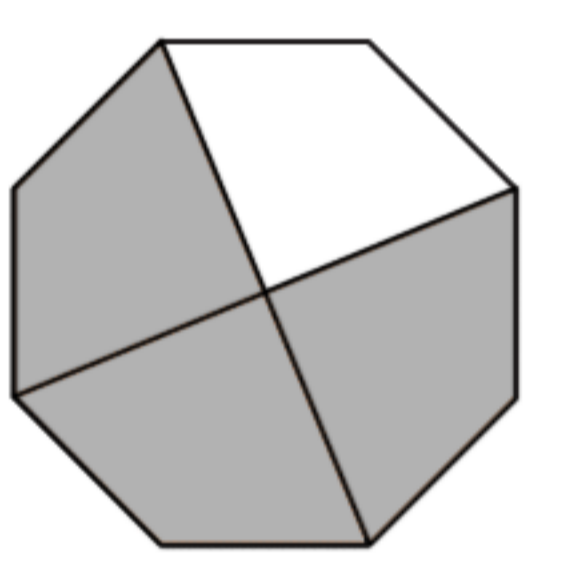
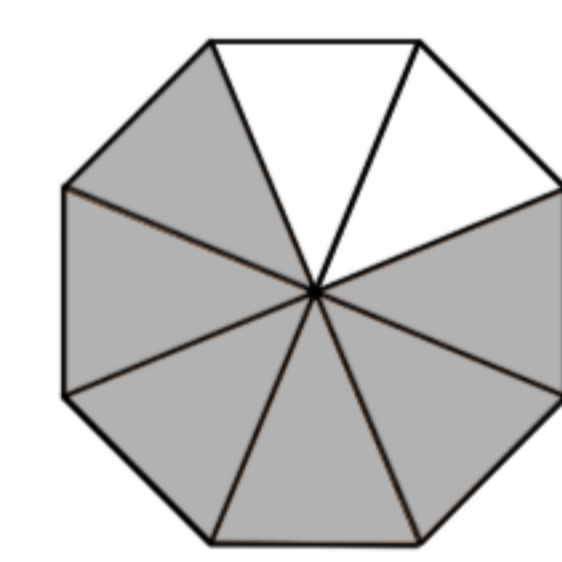
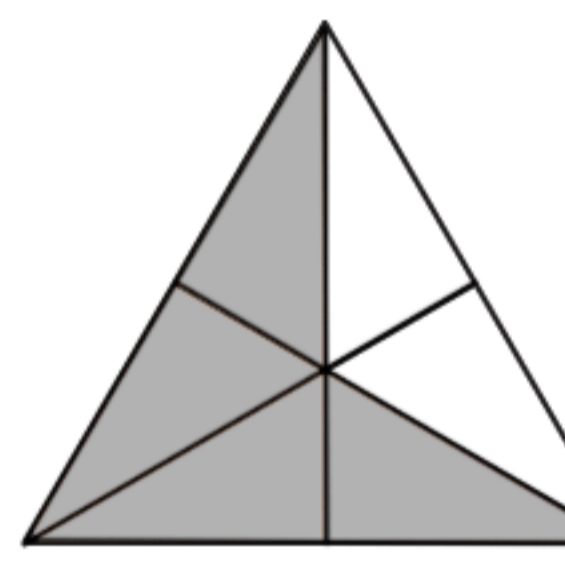
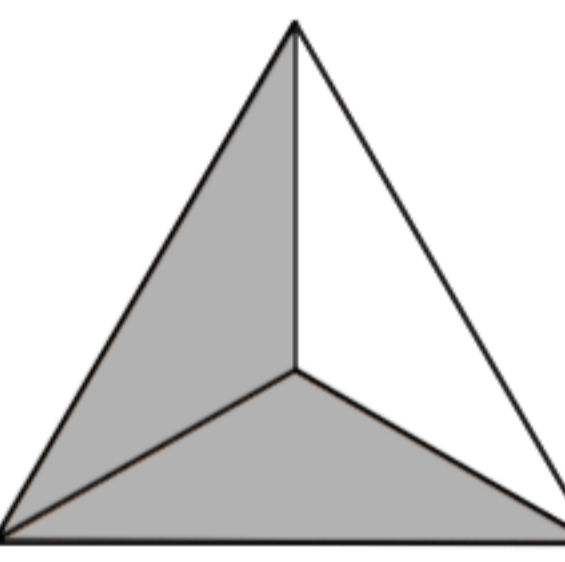
 $\frac{3}{4} \begin{matrix} \rightarrow \times 2 \\ \rightarrow \times 2 \end{matrix} = \frac{\quad}{\quad}$ 	 $\frac{4}{6} \begin{matrix} \rightarrow : 2 \\ \rightarrow : 2 \end{matrix} = \frac{\quad}{\quad}$ 
La frazione $\frac{3}{4}$ è equivalente a .....	La frazione $\frac{4}{6}$ è equivalente a .....

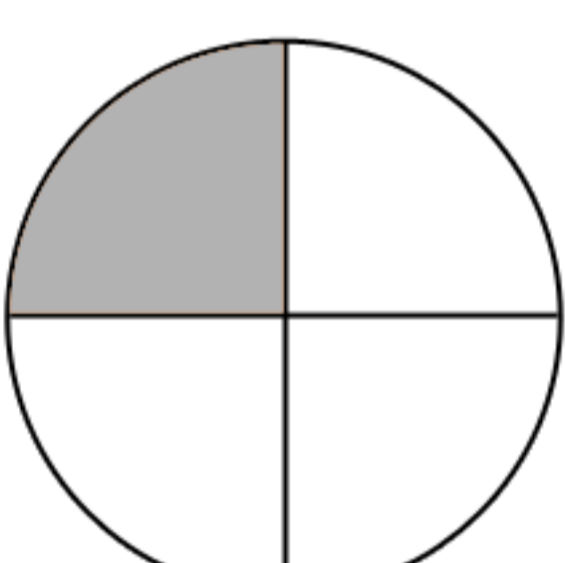
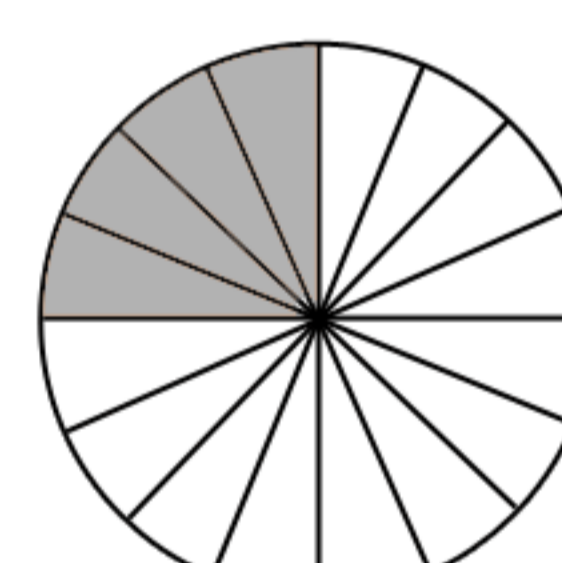
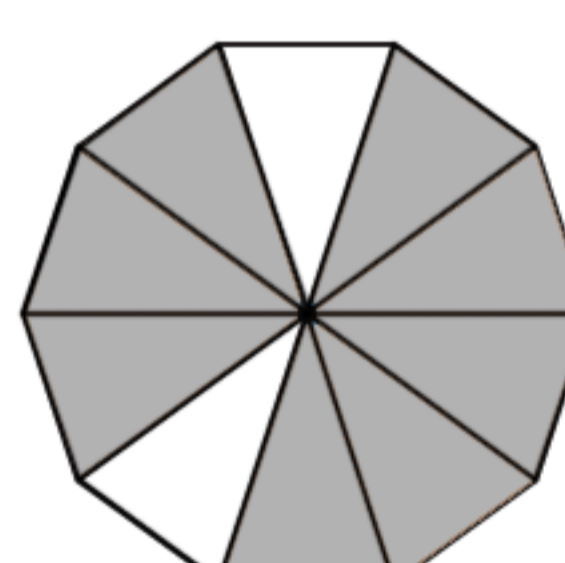
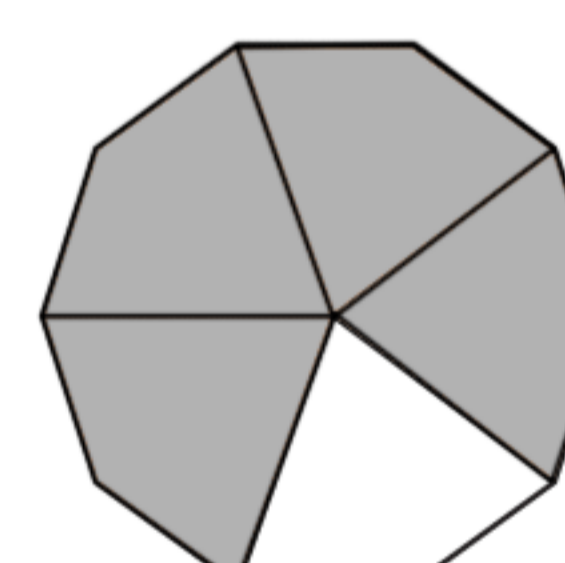
 $\frac{1}{4} \begin{matrix} \rightarrow \times 4 \\ \rightarrow \times 4 \end{matrix} = \frac{\quad}{\quad}$ 	 $\frac{8}{10} \begin{matrix} \rightarrow : 2 \\ \rightarrow : 2 \end{matrix} = \frac{\quad}{\quad}$ 
La frazione $\frac{1}{4}$ è equivalente a .....	La frazione $\frac{8}{10}$ è equivalente a .....

- Trova una frazione equivalente per ciascuna delle seguenti frazioni.

$\frac{2}{3} = \frac{\dots}{\dots}$	$\frac{6}{9} = \frac{\dots}{\dots}$	$\frac{2}{6} = \frac{\dots}{\dots}$	$\frac{4}{20} = \frac{\dots}{\dots}$	$\frac{9}{12} = \frac{\dots}{\dots}$	$\frac{14}{21} = \frac{\dots}{\dots}$	$\frac{12}{14} = \frac{\dots}{\dots}$
$\frac{2}{4} = \frac{\dots}{\dots}$	$\frac{2}{10} = \frac{\dots}{\dots}$	$\frac{4}{8} = \frac{\dots}{\dots}$	$\frac{8}{10} = \frac{\dots}{\dots}$	$\frac{10}{15} = \frac{\dots}{\dots}$	$\frac{4}{16} = \frac{\dots}{\dots}$	$\frac{7}{21} = \frac{\dots}{\dots}$
$\frac{8}{10} = \frac{\dots}{\dots}$	$\frac{4}{12} = \frac{\dots}{\dots}$	$\frac{5}{10} = \frac{\dots}{\dots}$	$\frac{6}{14} = \frac{\dots}{\dots}$	$\frac{12}{18} = \frac{\dots}{\dots}$	$\frac{9}{18} = \frac{\dots}{\dots}$	$\frac{8}{16} = \frac{\dots}{\dots}$
$\frac{3}{6} = \frac{\dots}{\dots}$	$\frac{3}{15} = \frac{\dots}{\dots}$	$\frac{6}{18} = \frac{\dots}{\dots}$	$\frac{12}{16} = \frac{\dots}{\dots}$	$\frac{4}{6} = \frac{\dots}{\dots}$	$\frac{6}{12} = \frac{\dots}{\dots}$	$\frac{10}{12} = \frac{\dots}{\dots}$