

Sottrazioni con i disegni

- Conta, sottrai e scrivi il risultato nel riquadro di destra.

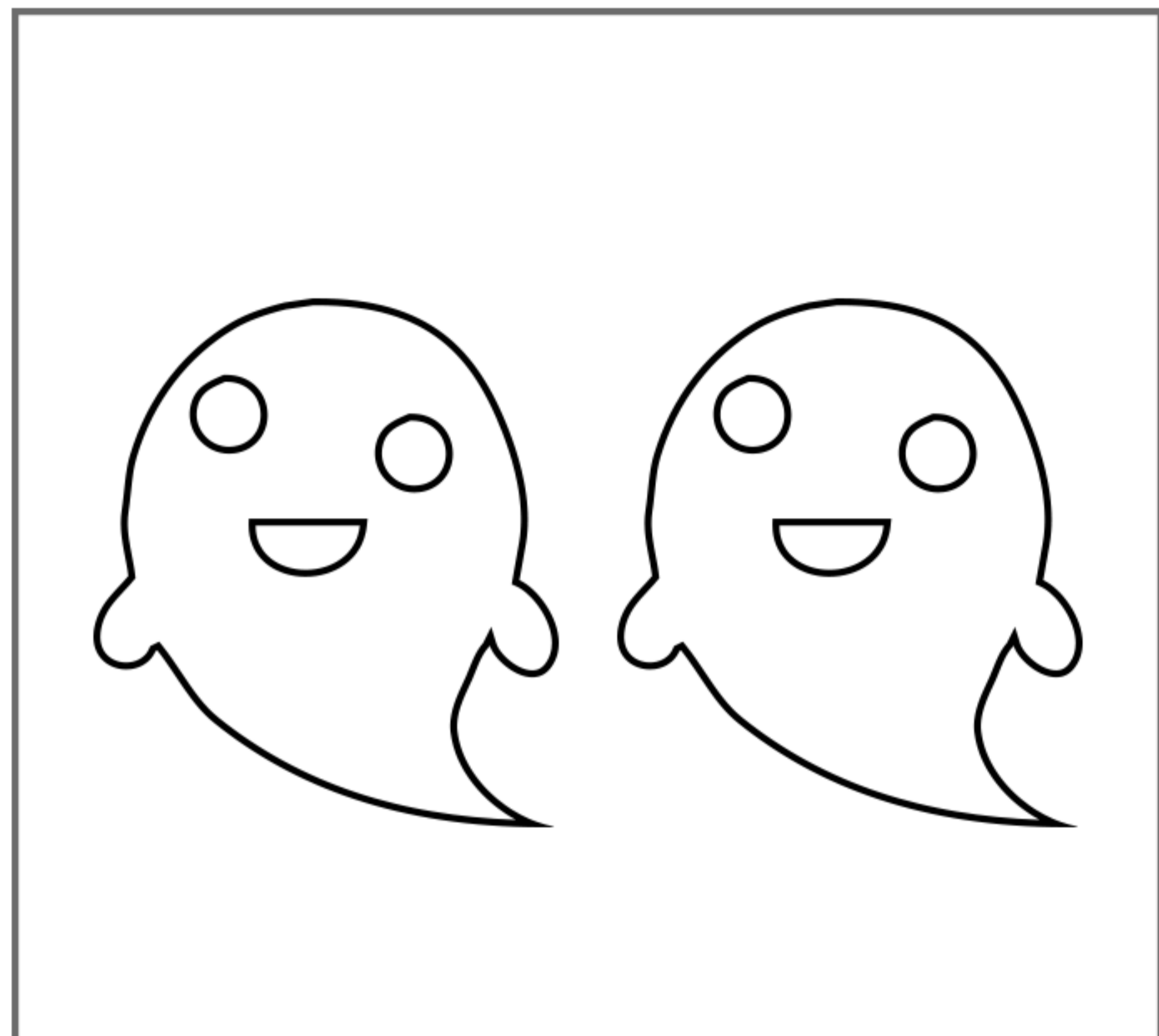

-

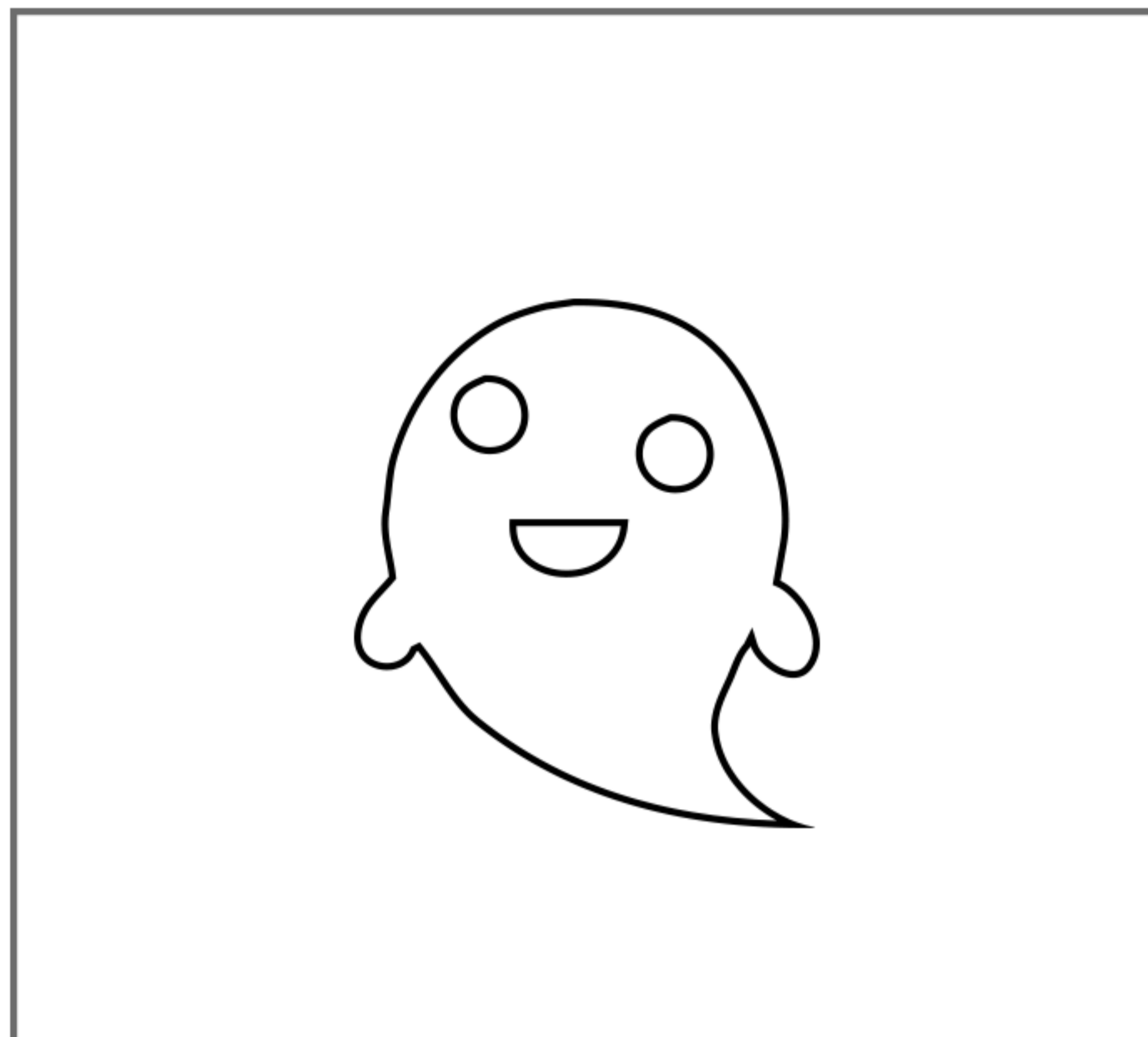

=

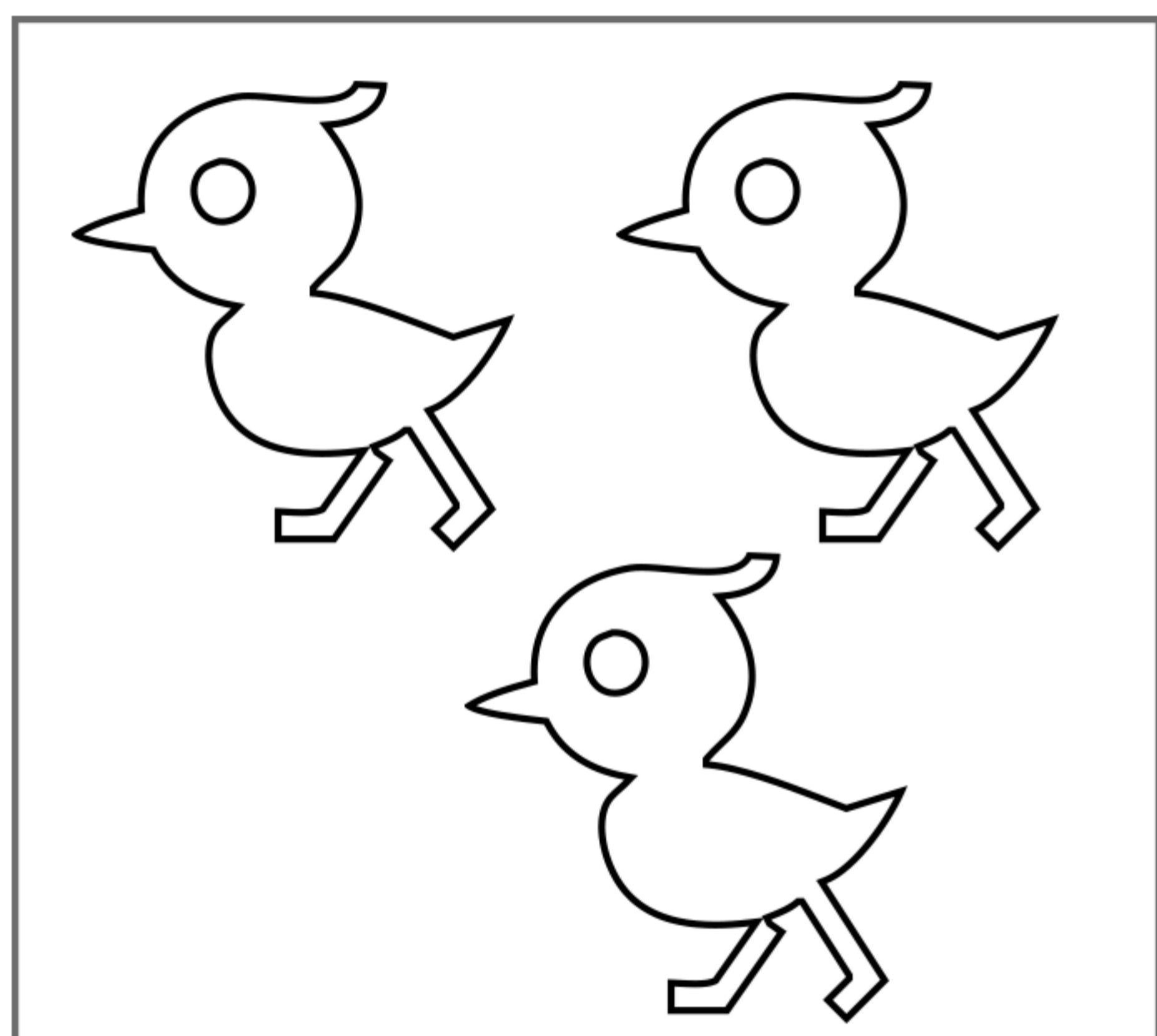
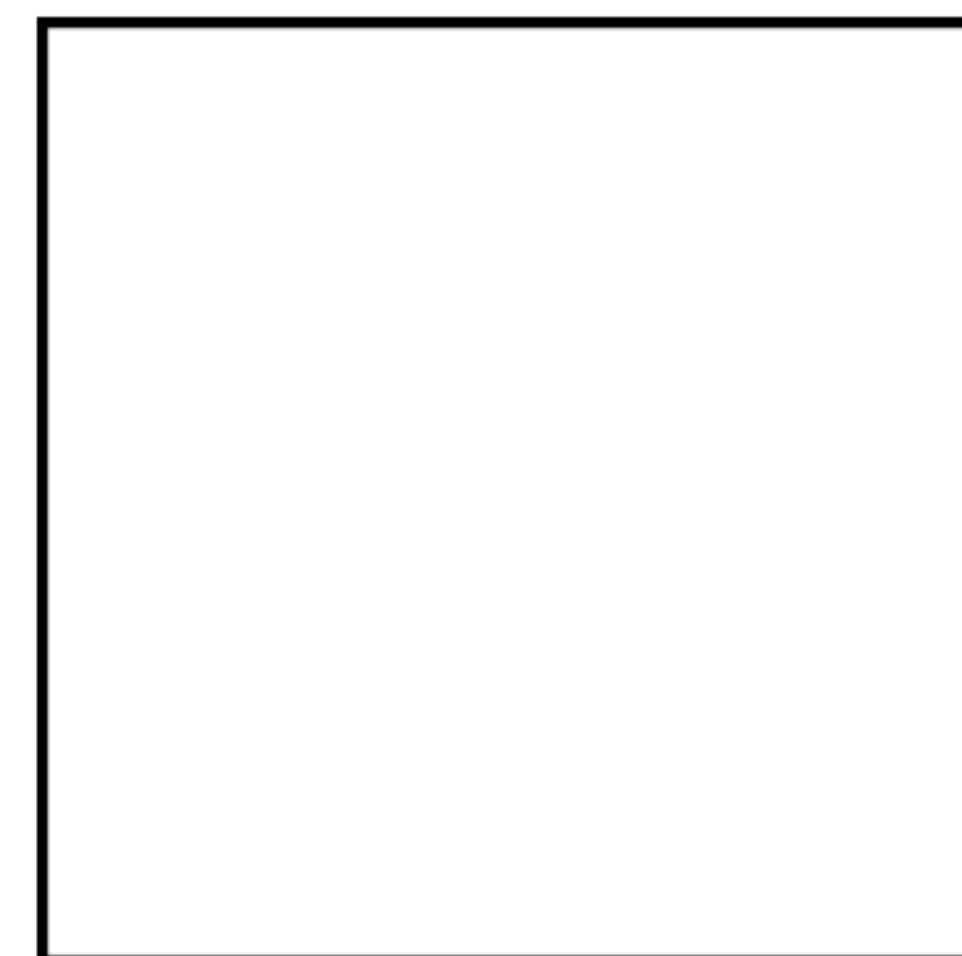

-

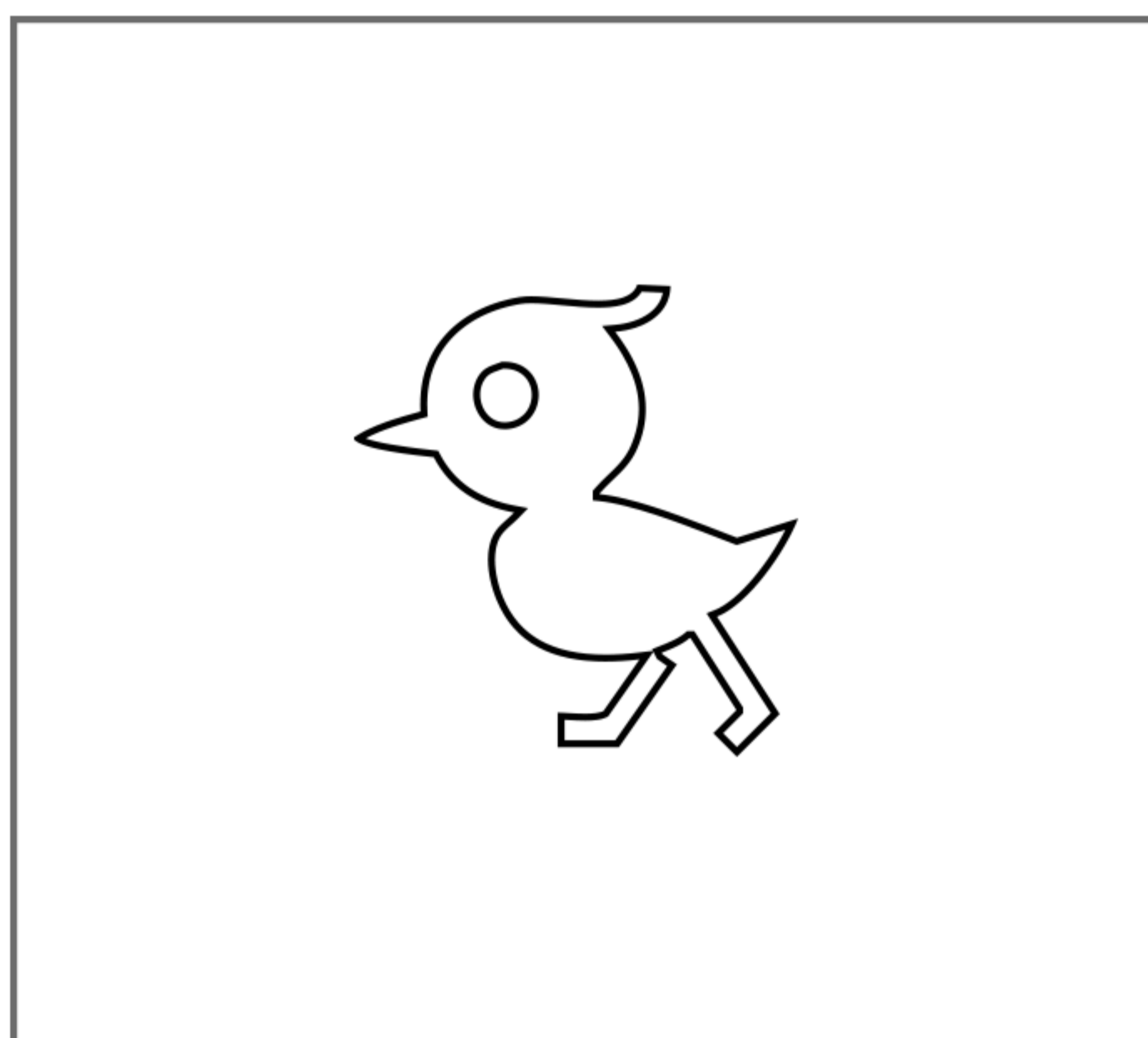

=

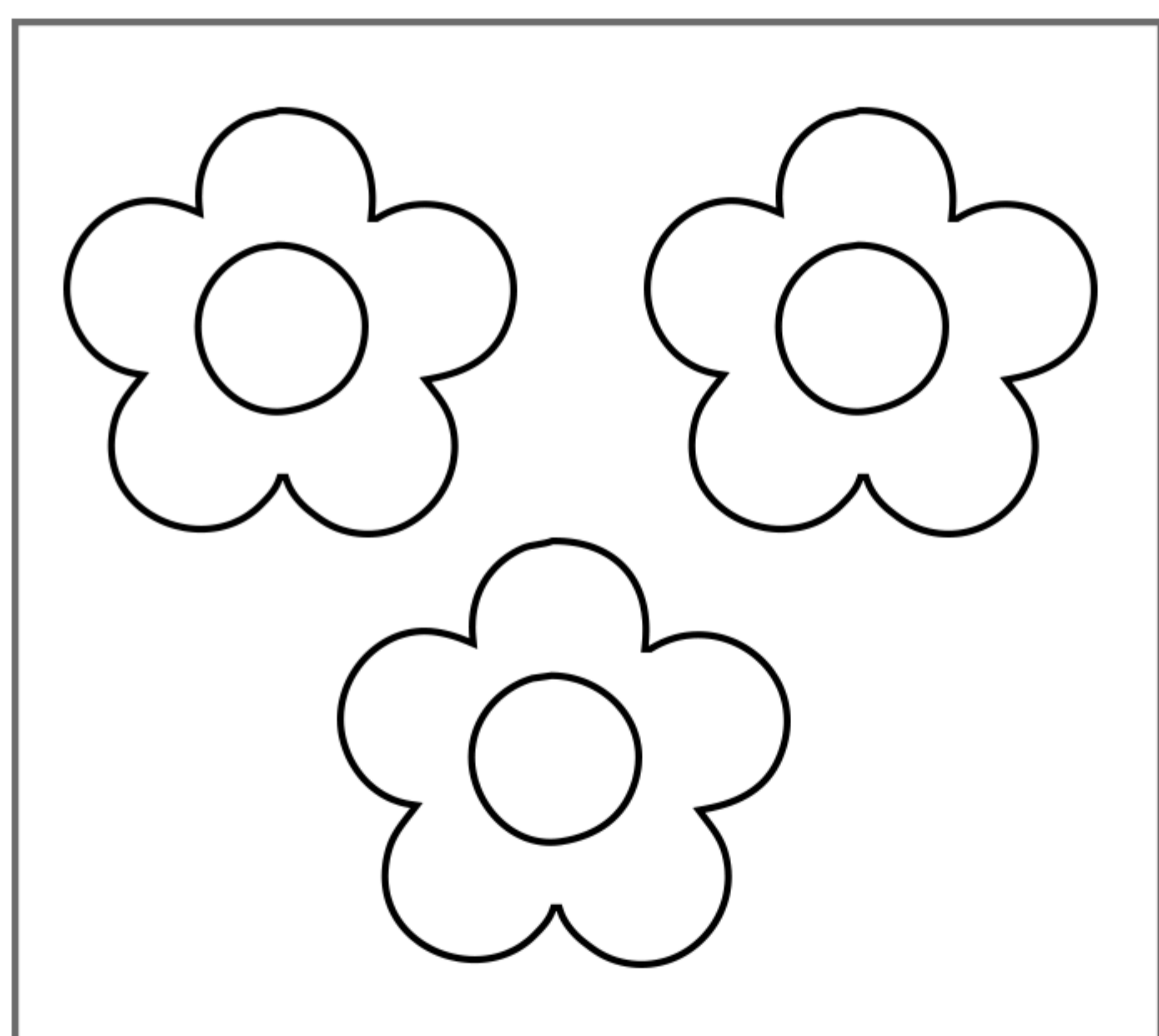
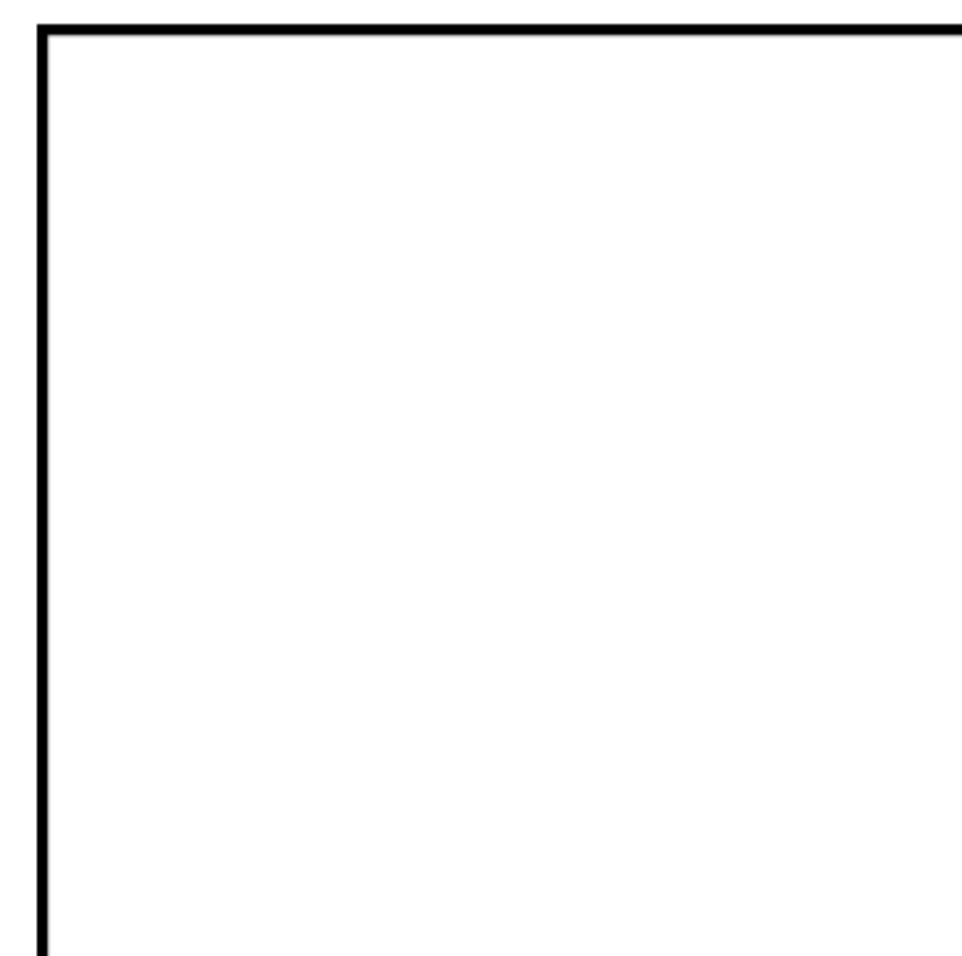

-

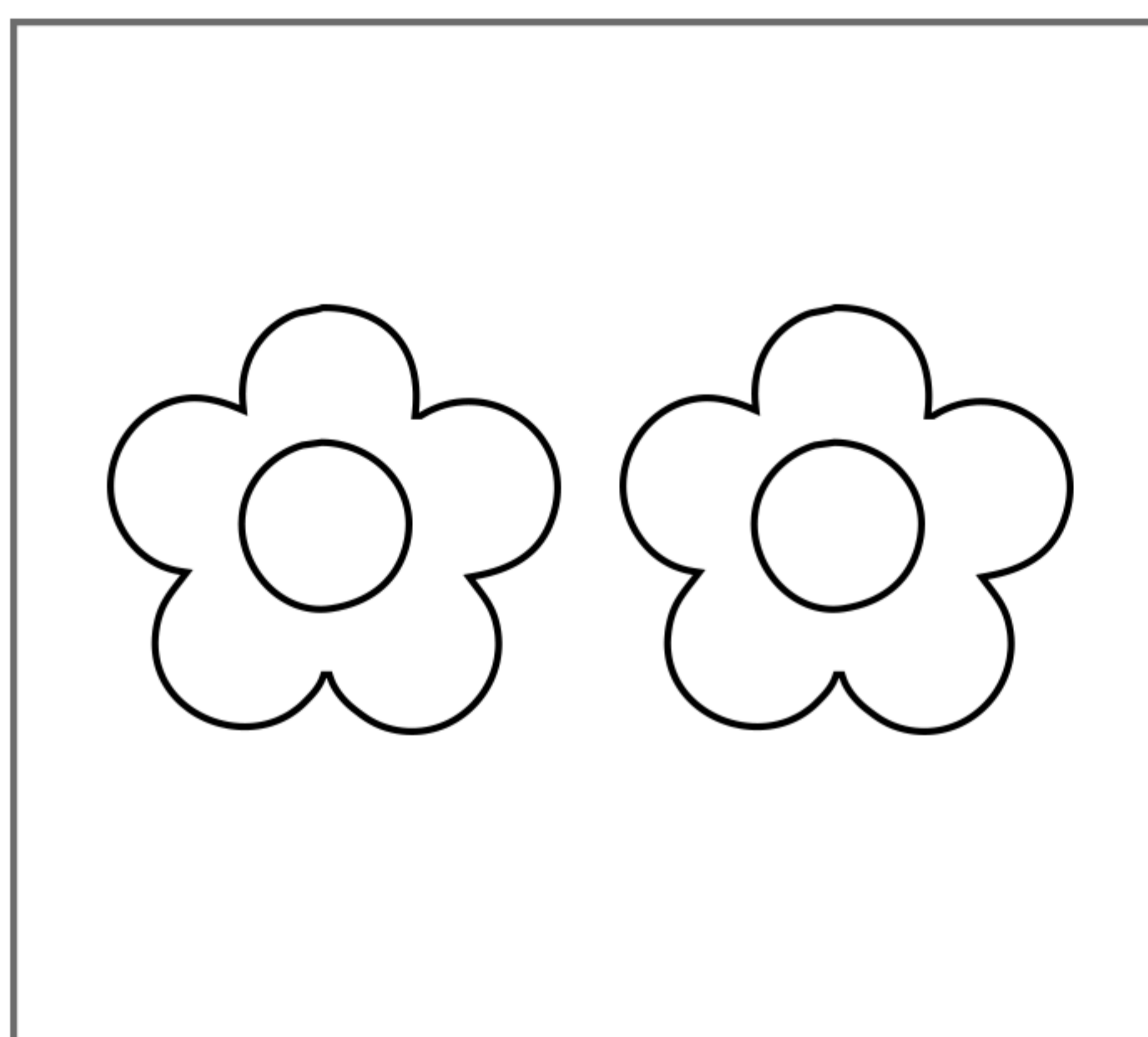

=

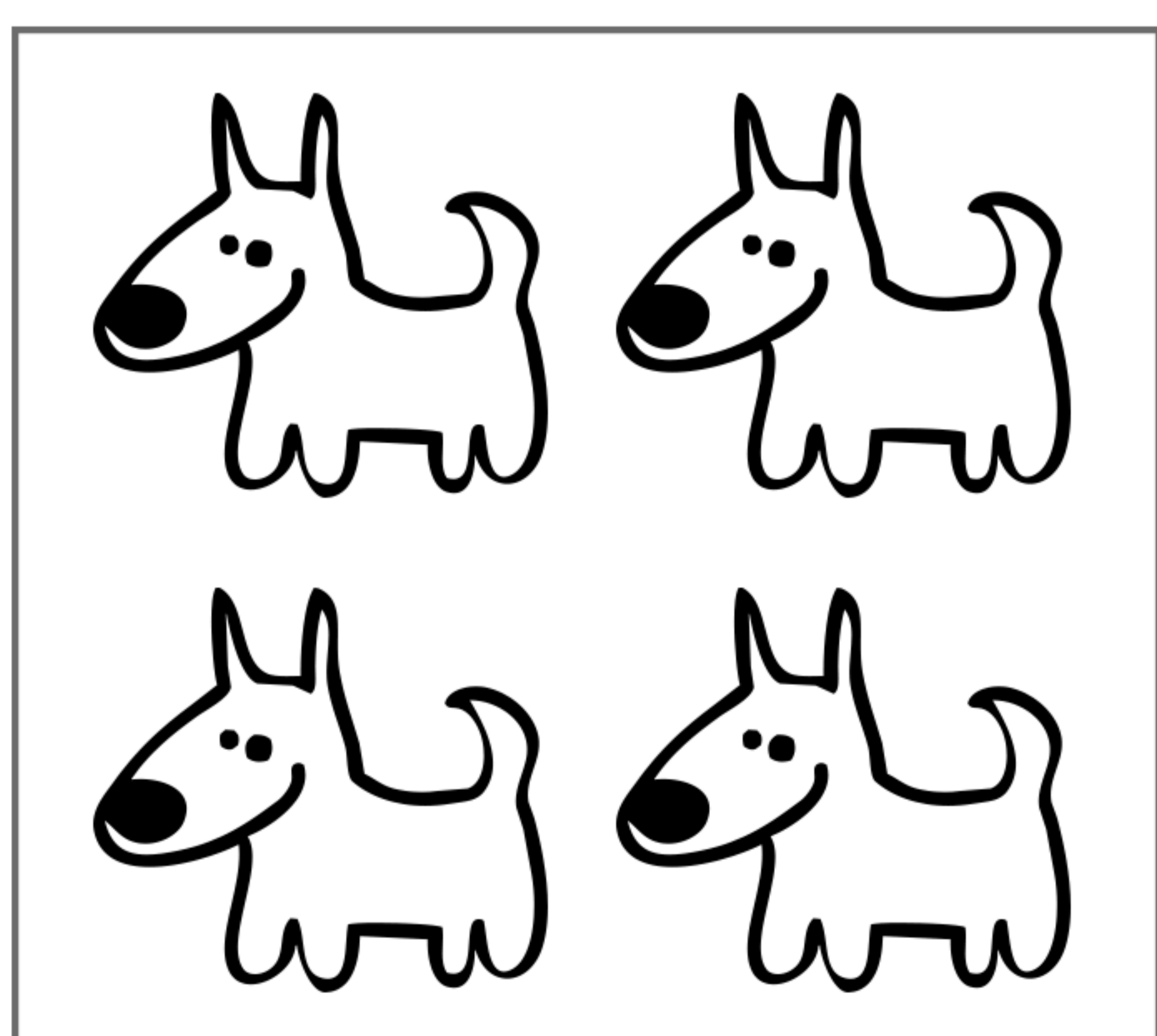
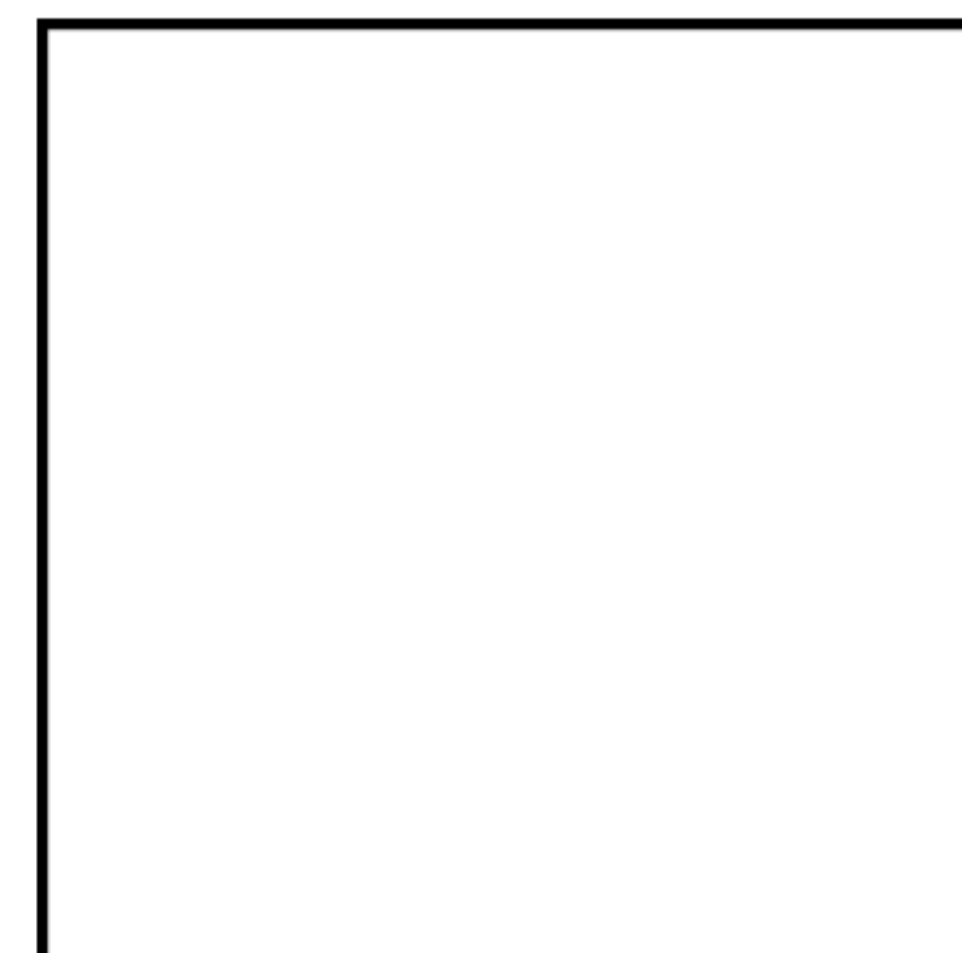

-

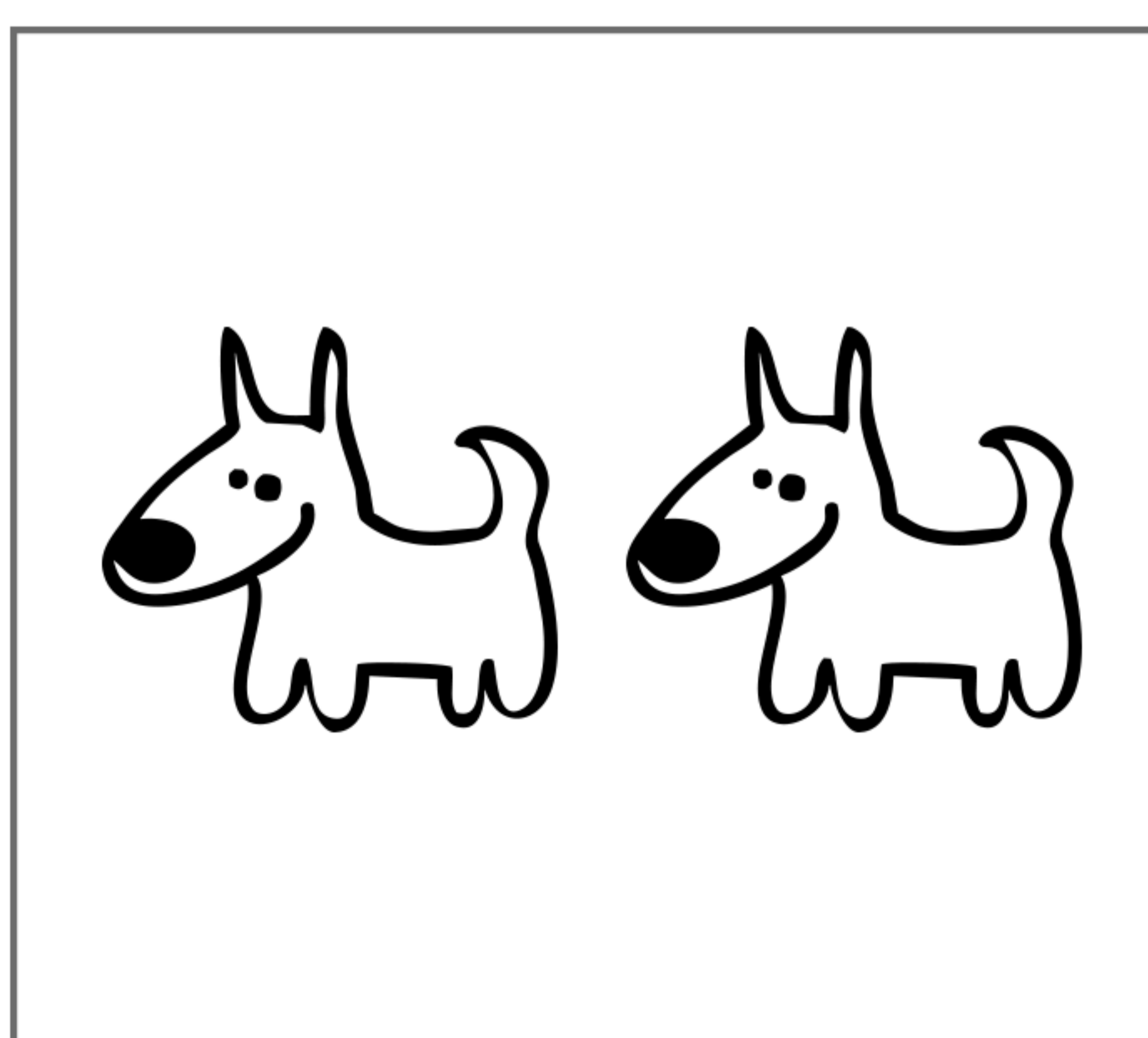

=

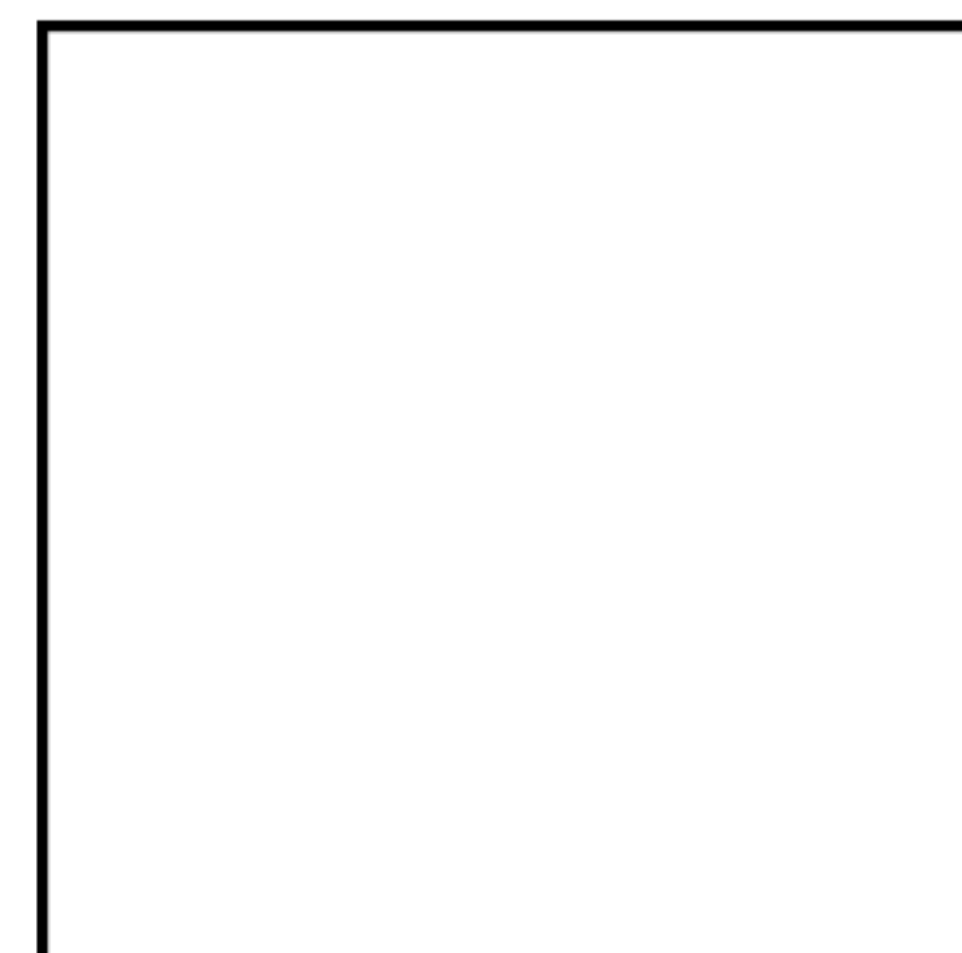

Sottrazioni con i disegni

- Conta, sottrai e scrivi il risultato nel riquadro di destra.

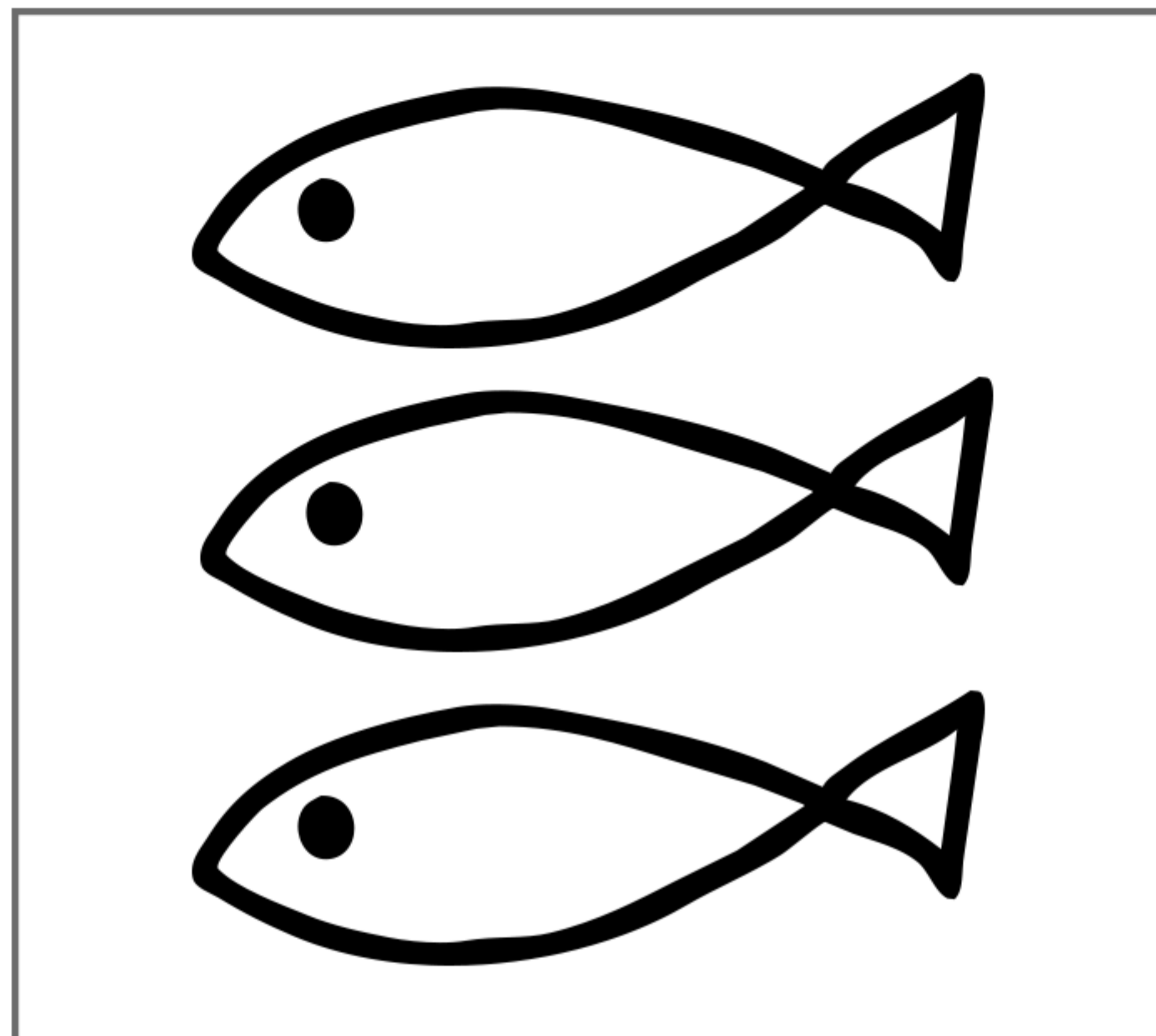

-

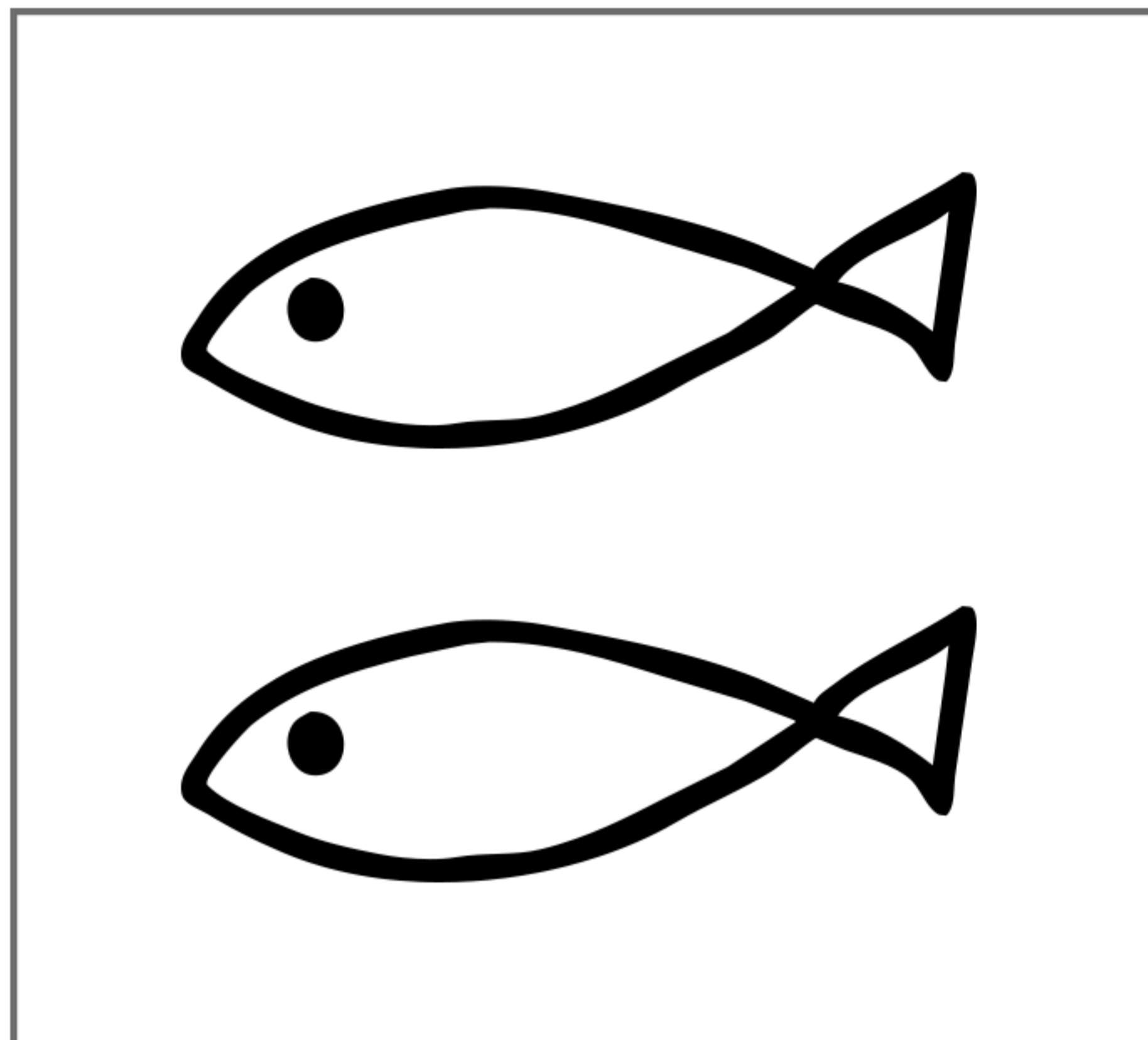

=

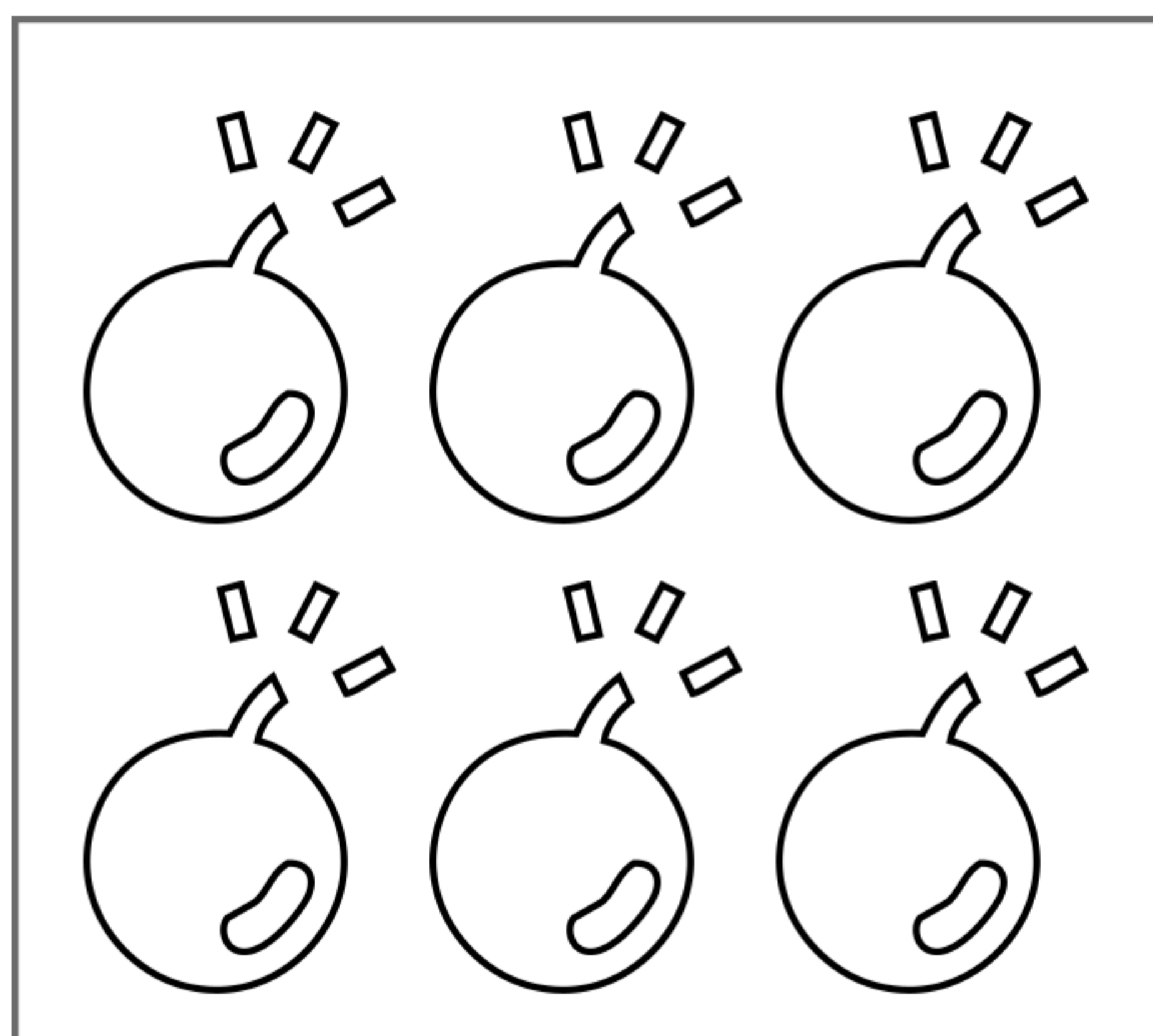
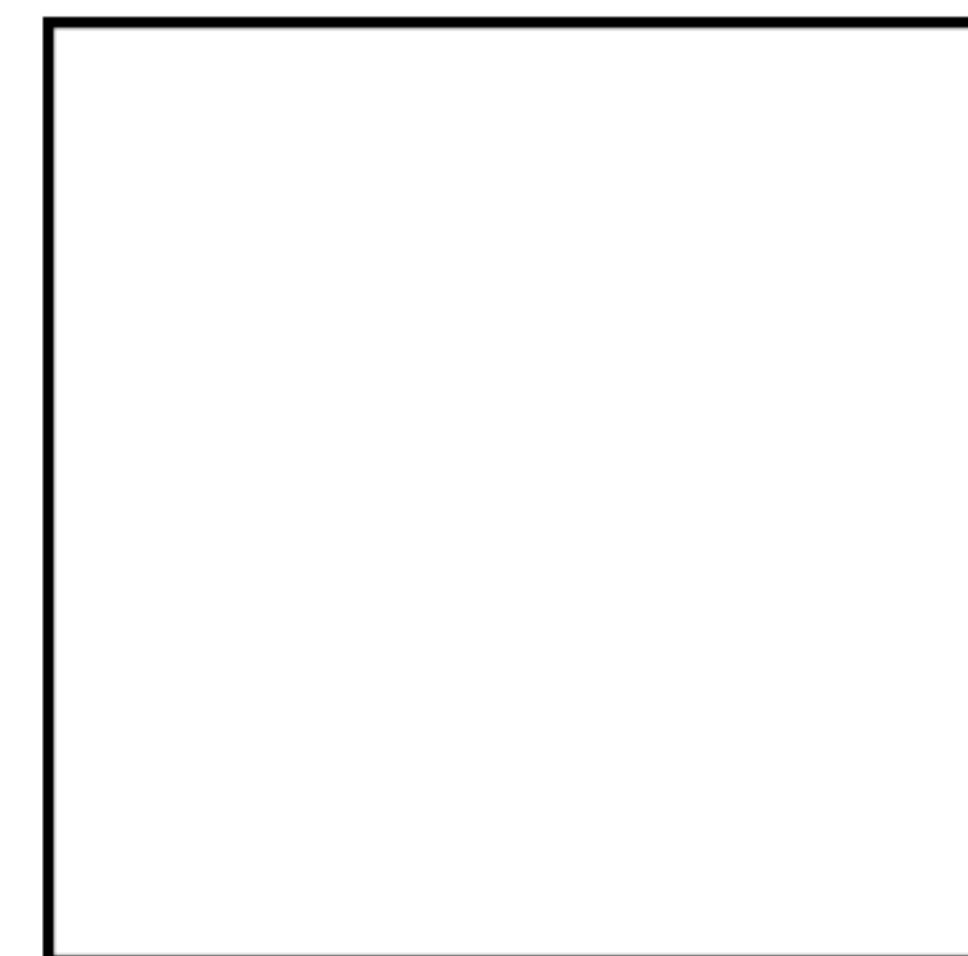

-

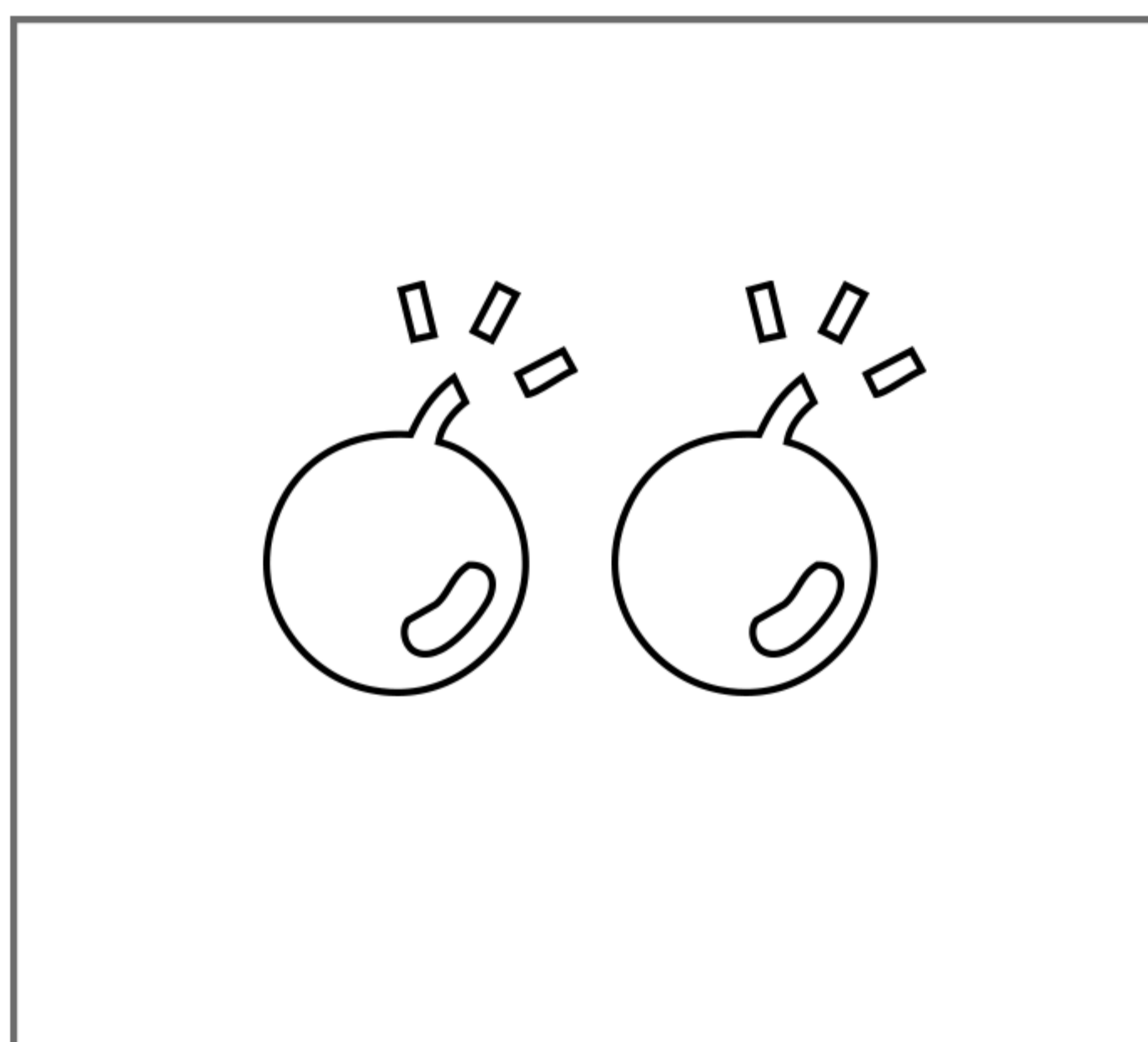

=

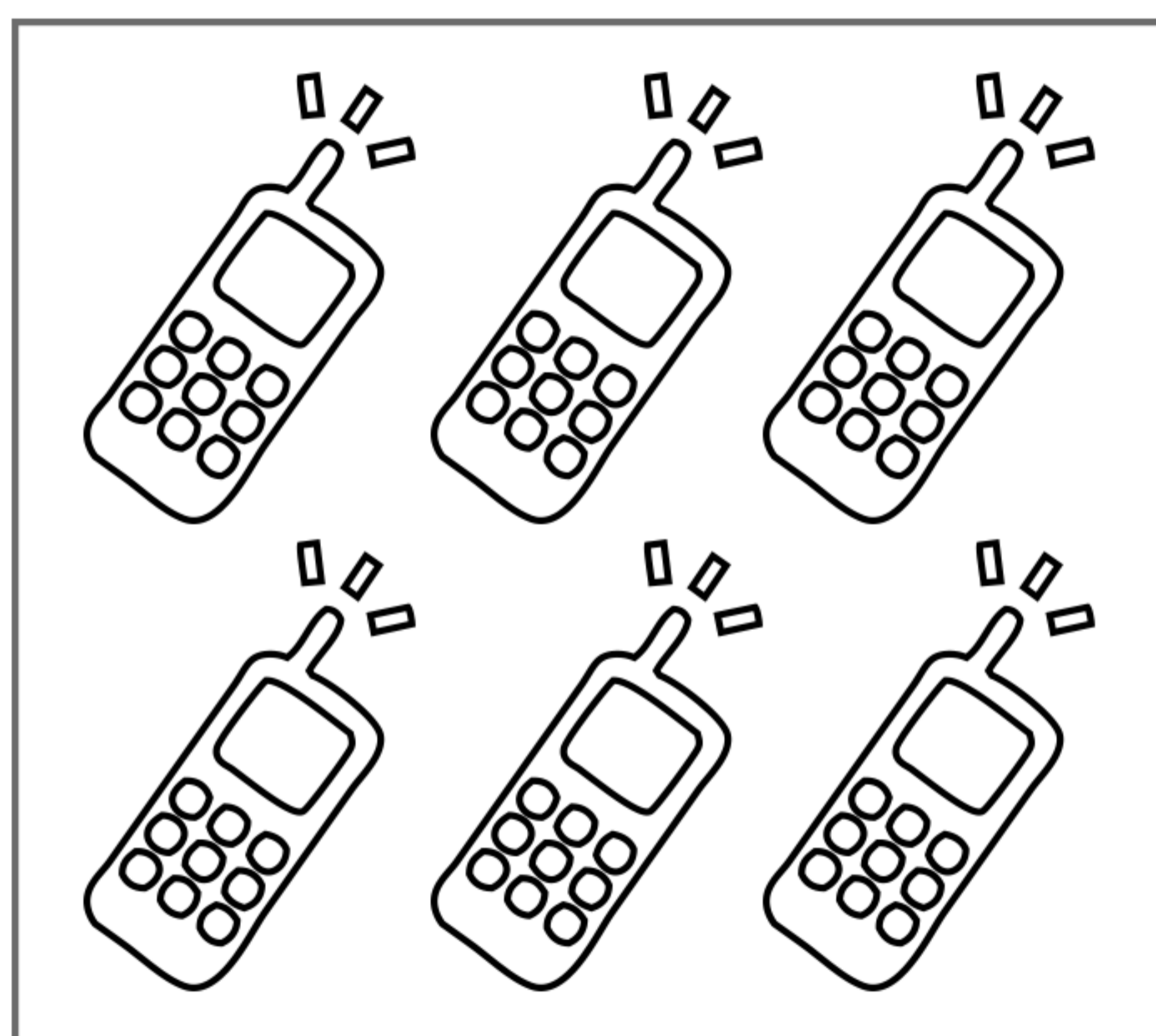
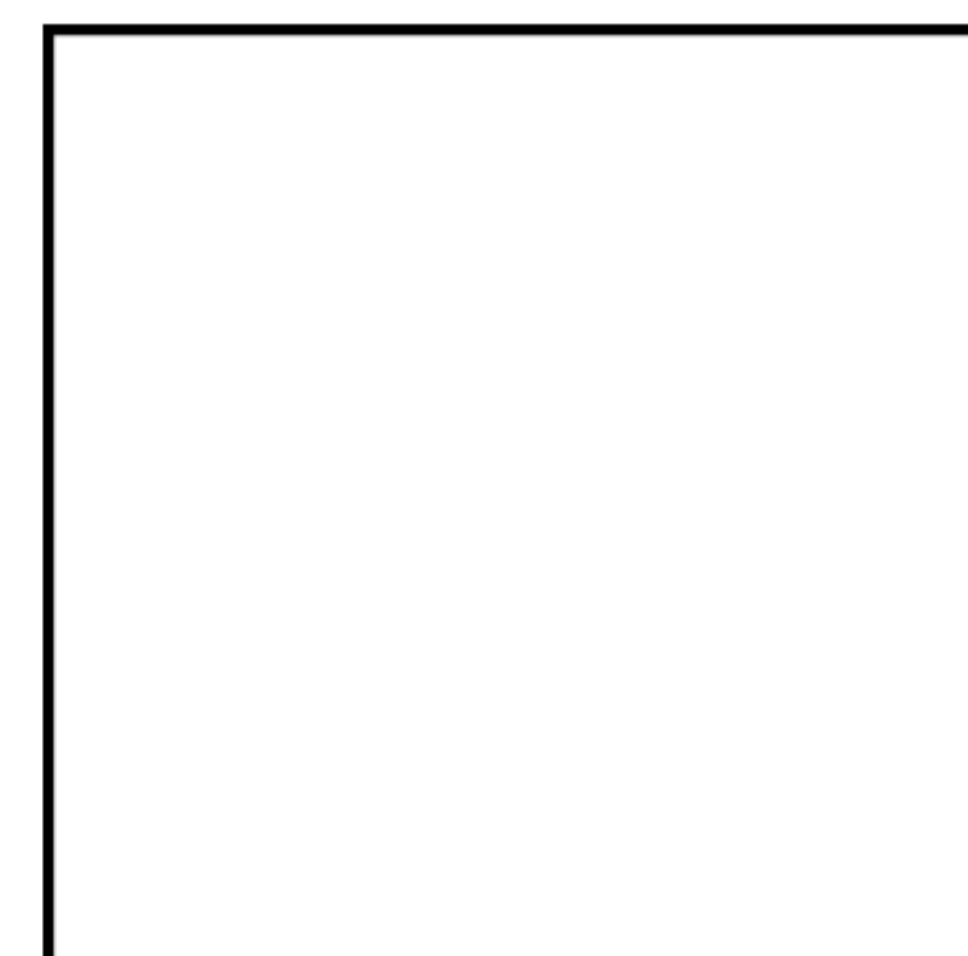

-

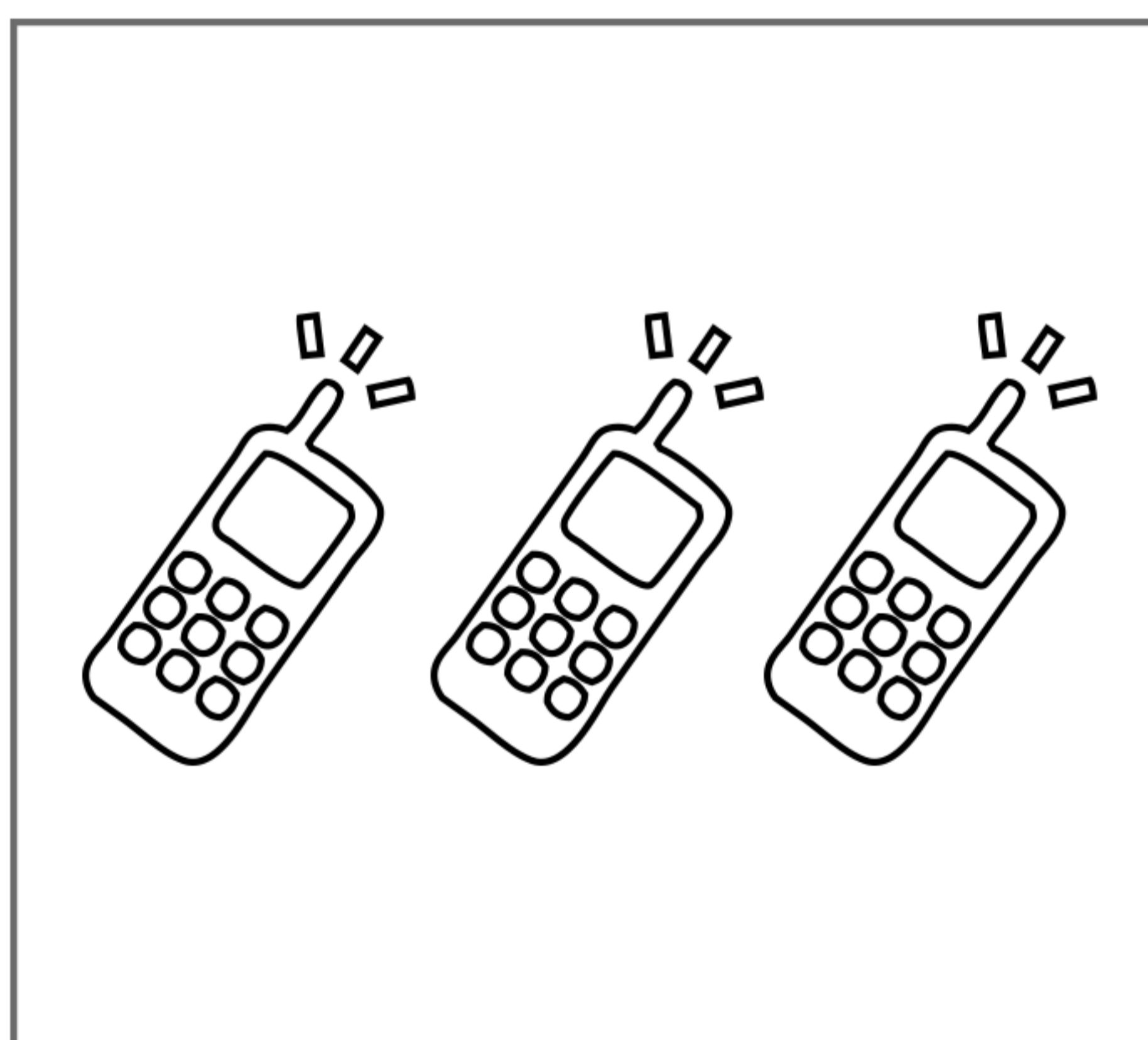

=

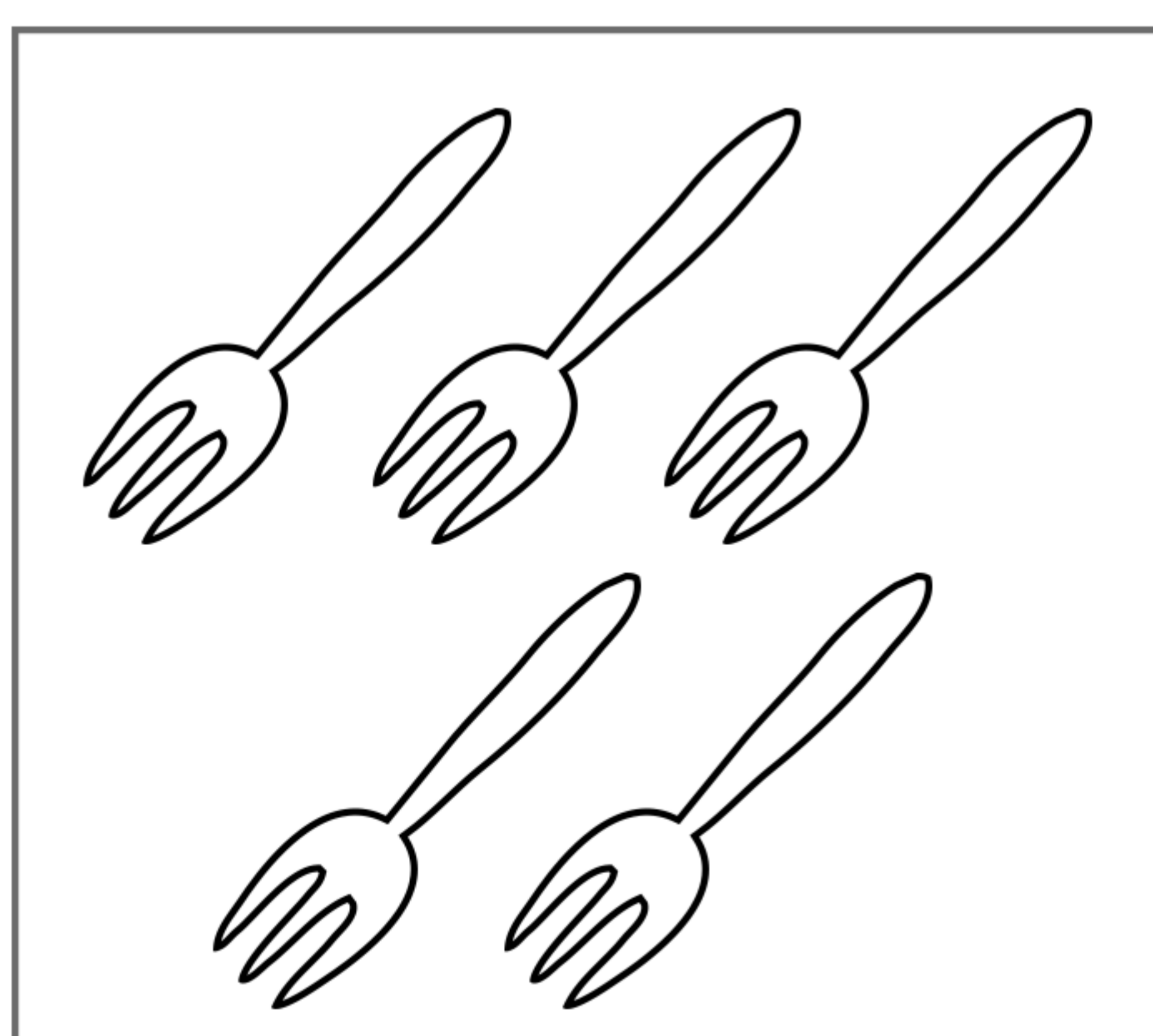
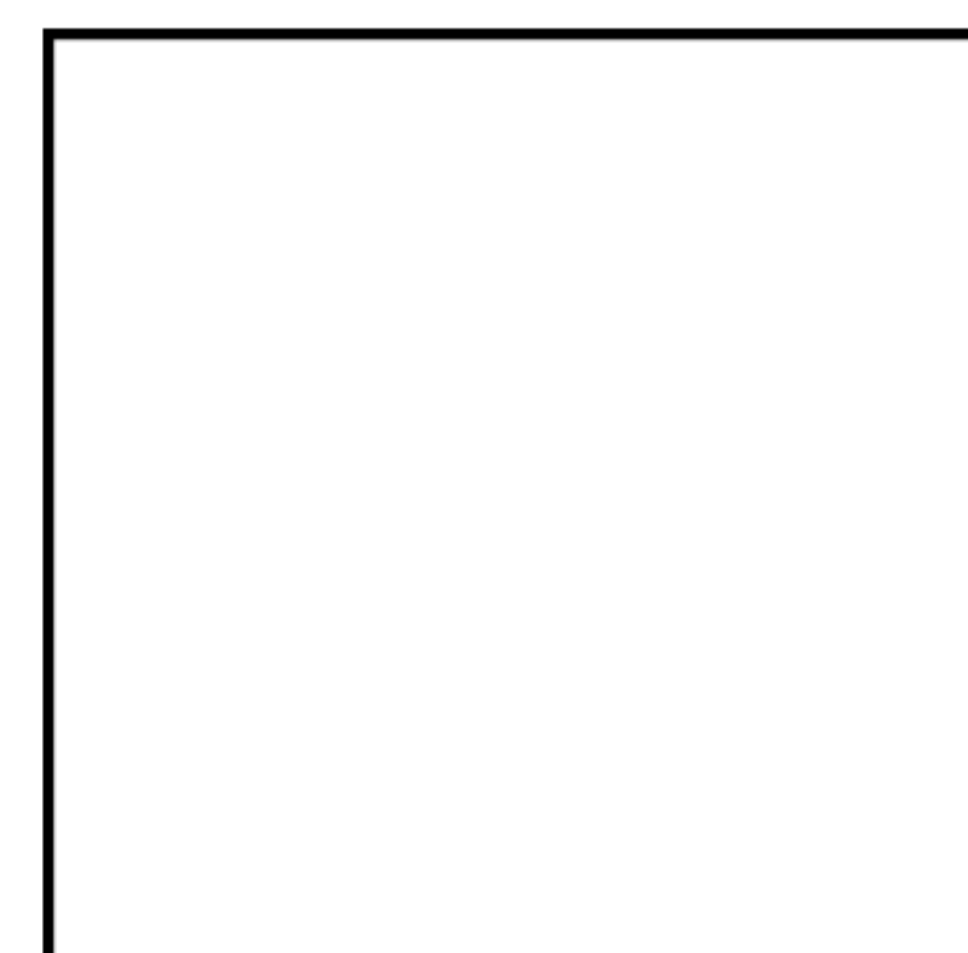

-

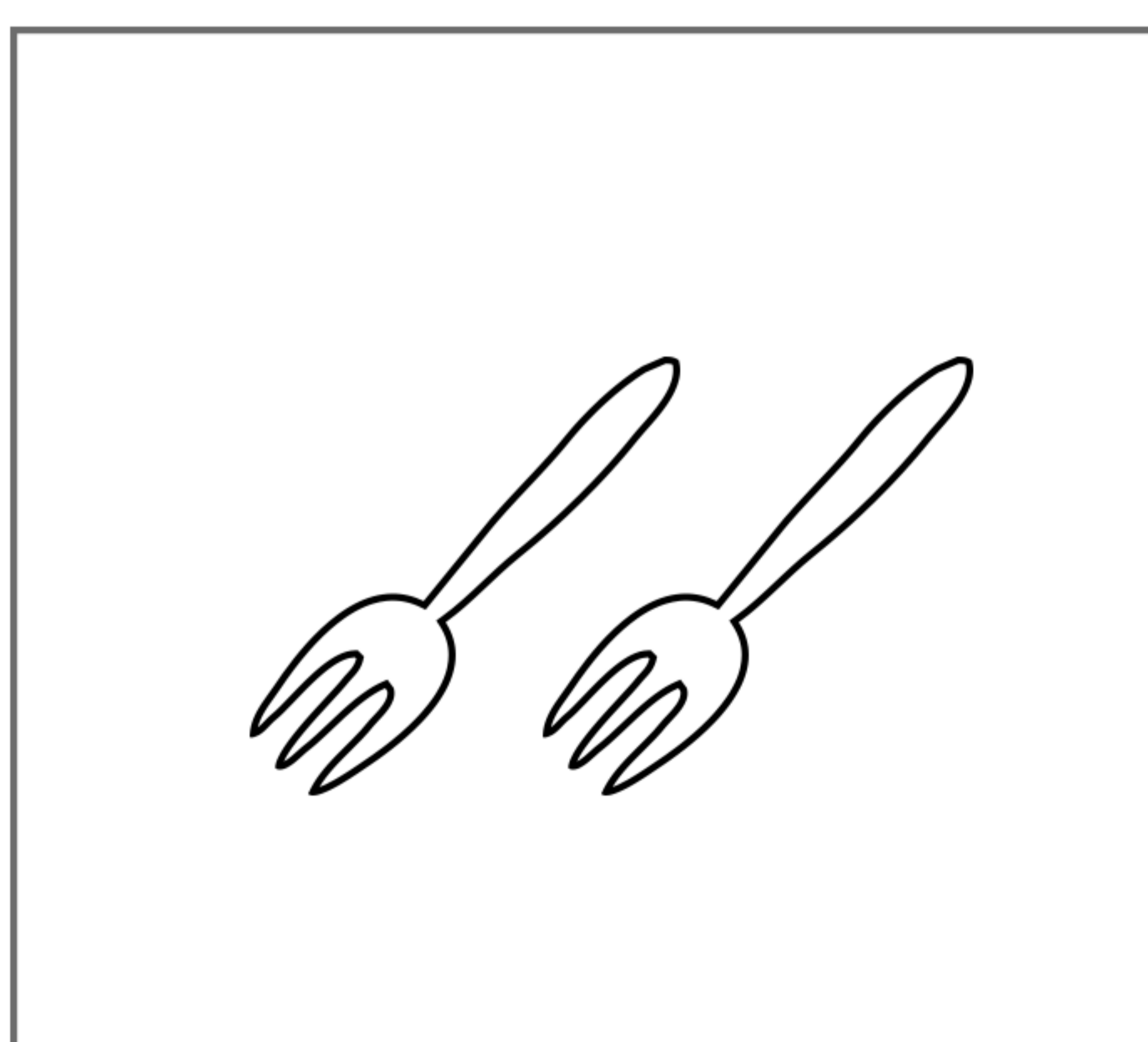

=



Sottrazioni con i disegni

- Conta, sottrai e scrivi il risultato nel riquadro di destra.

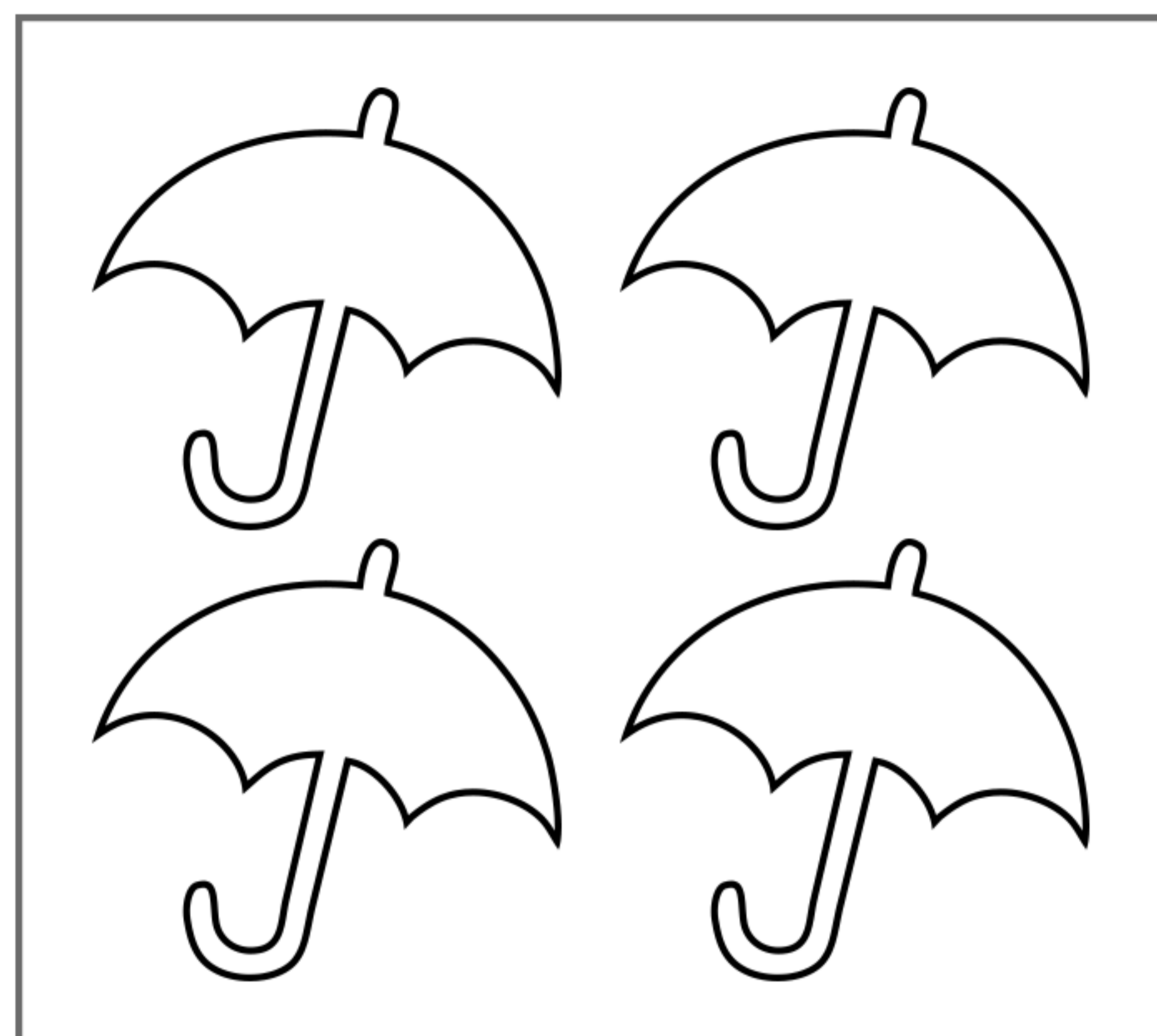

-

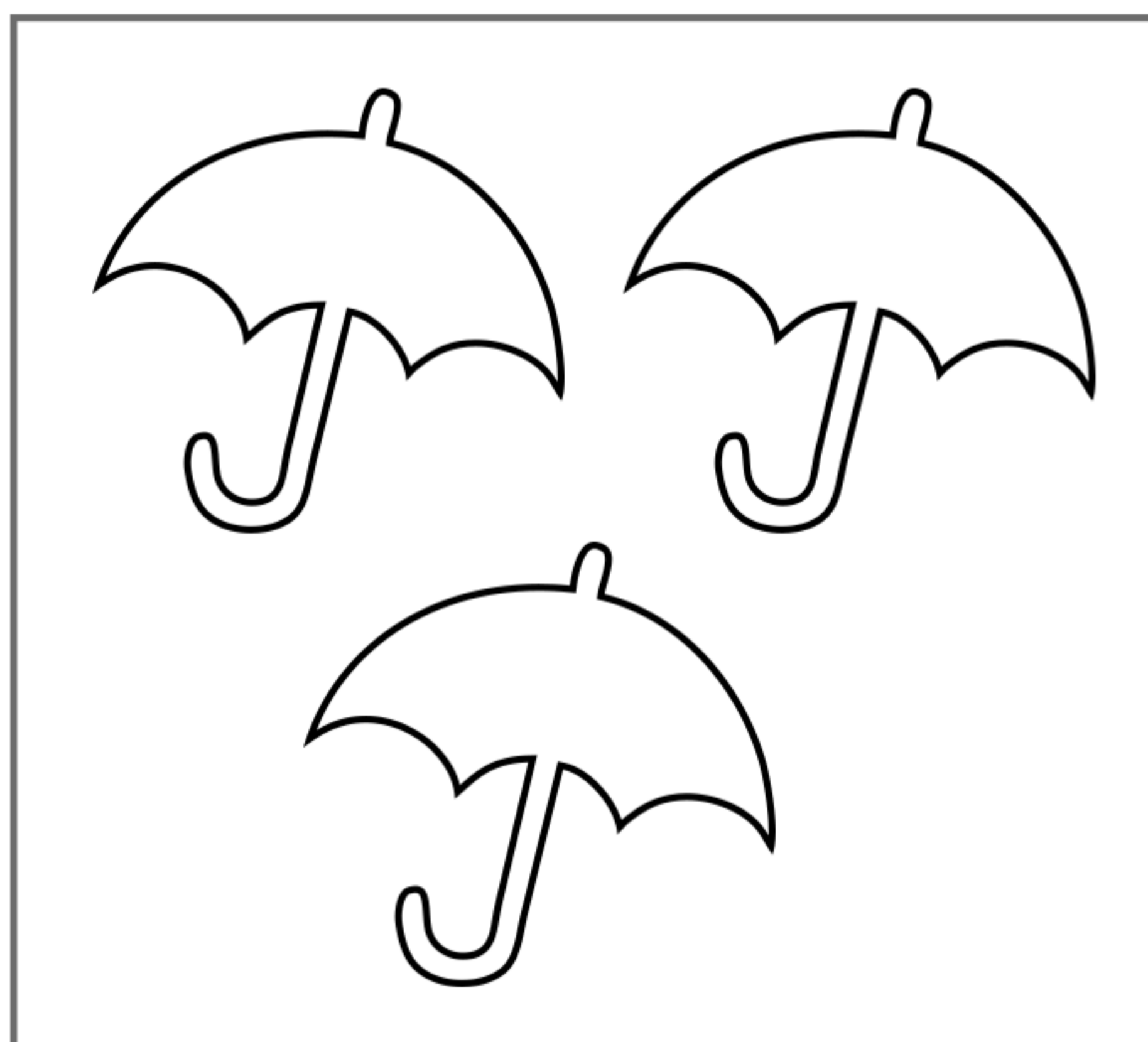

=

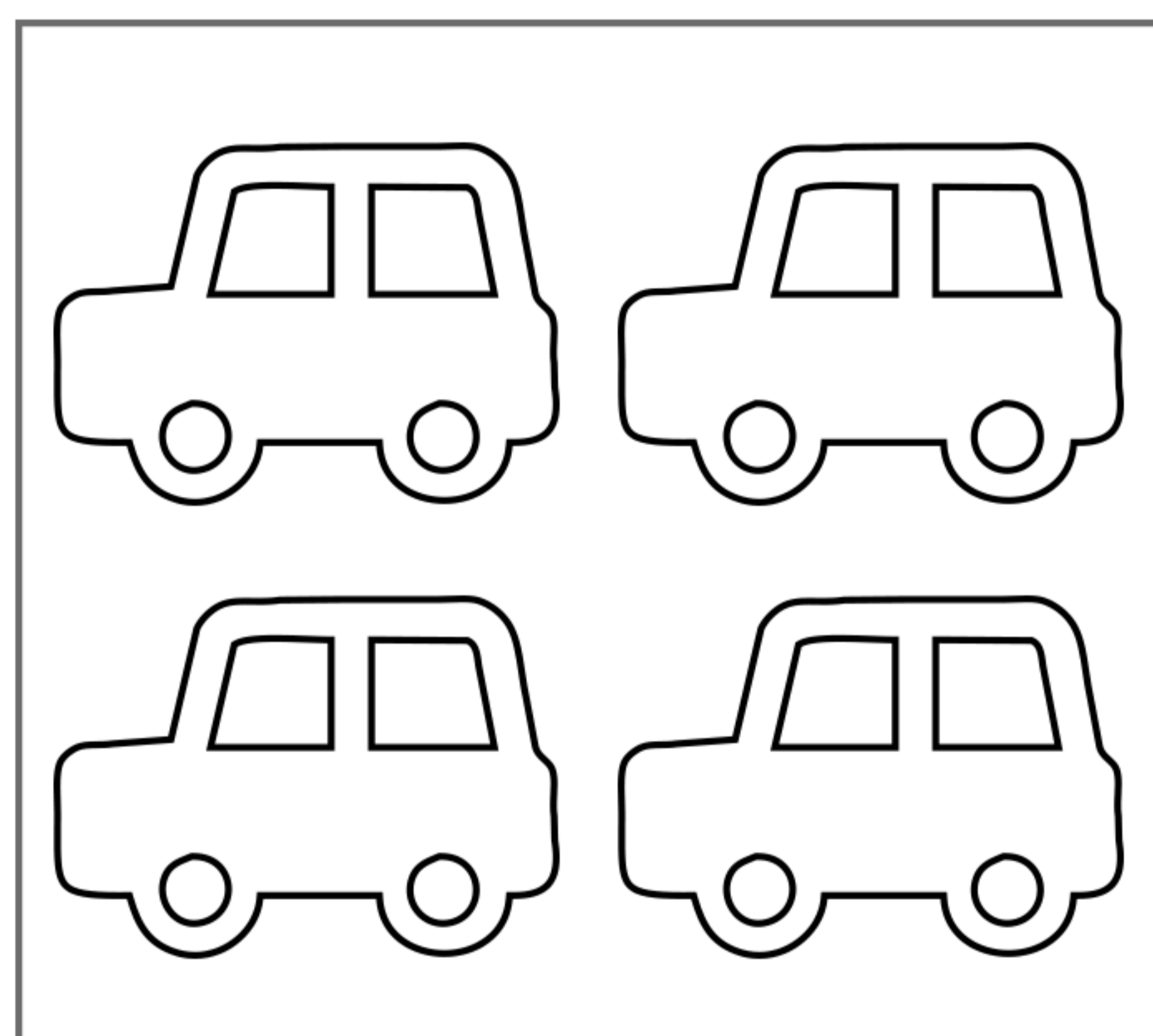
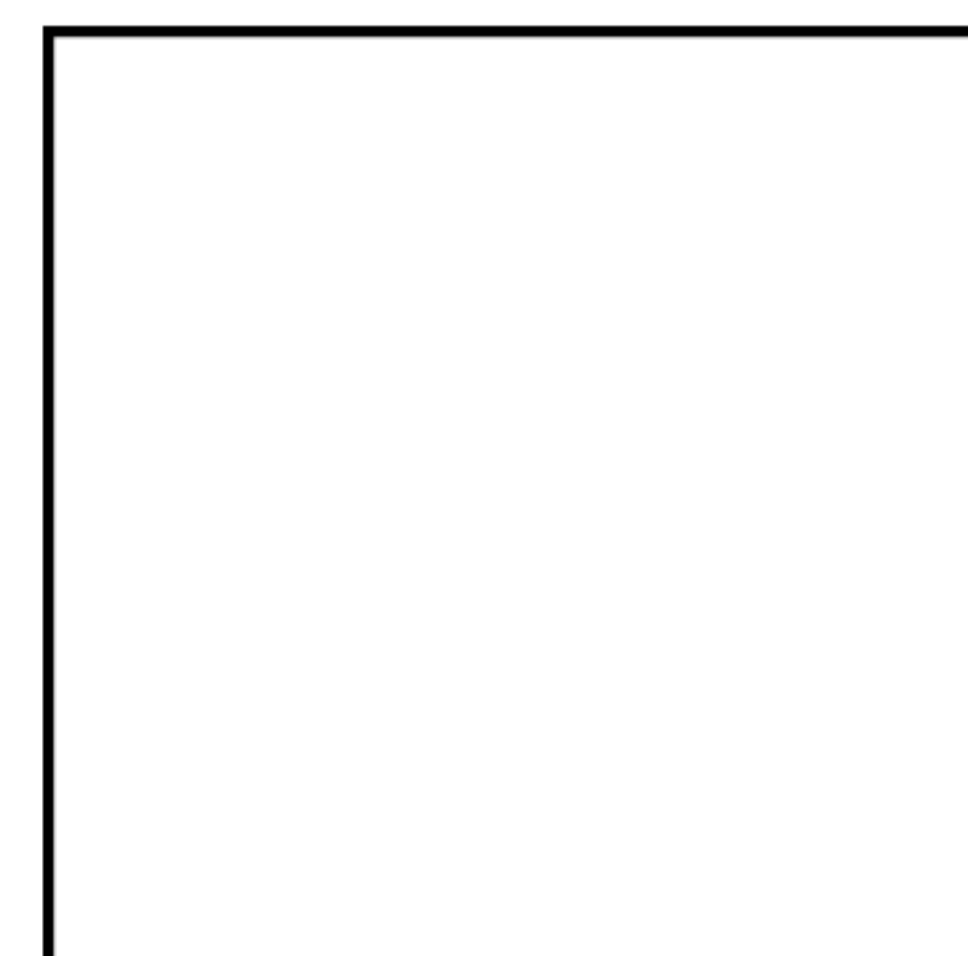

-

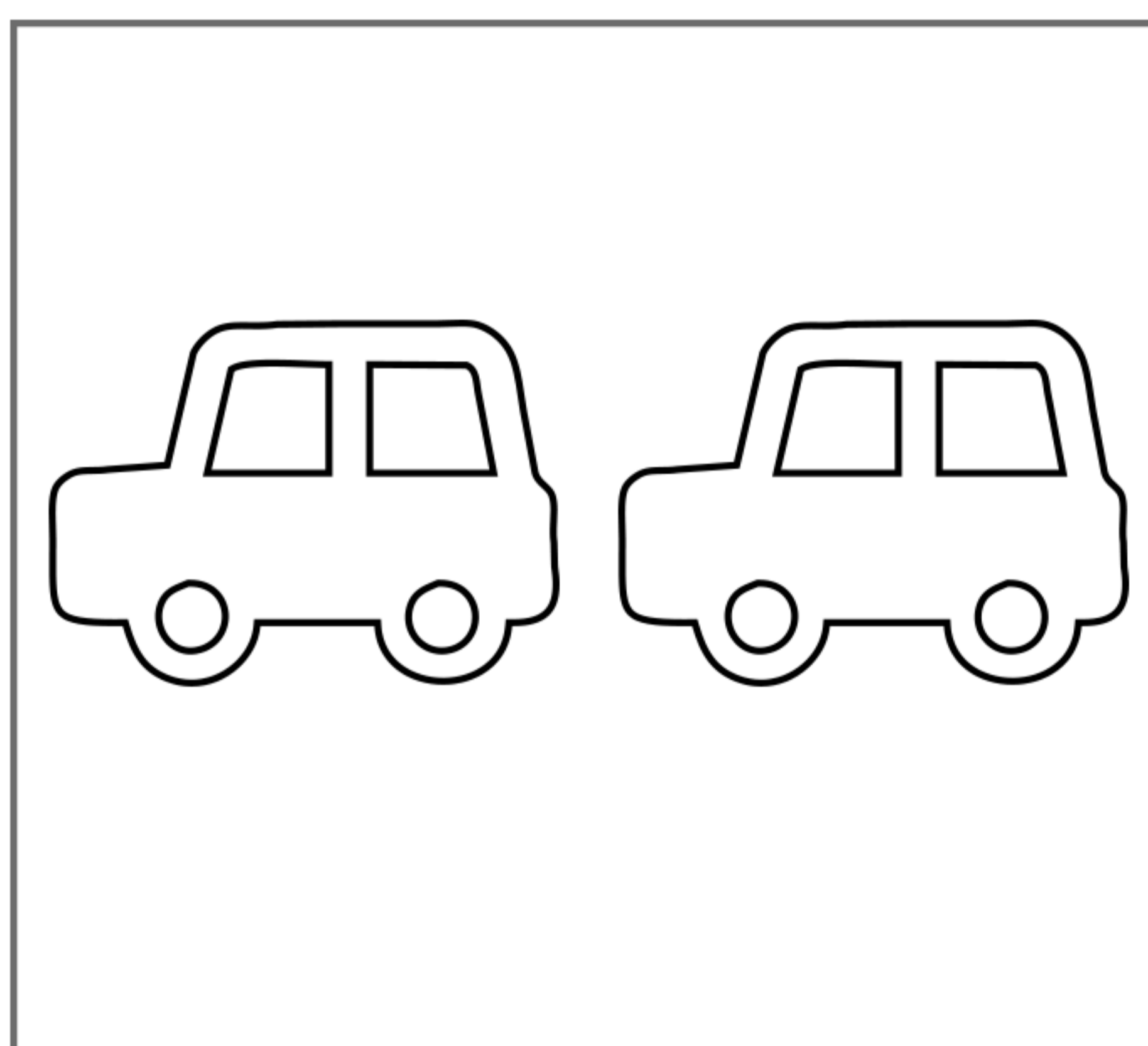

=

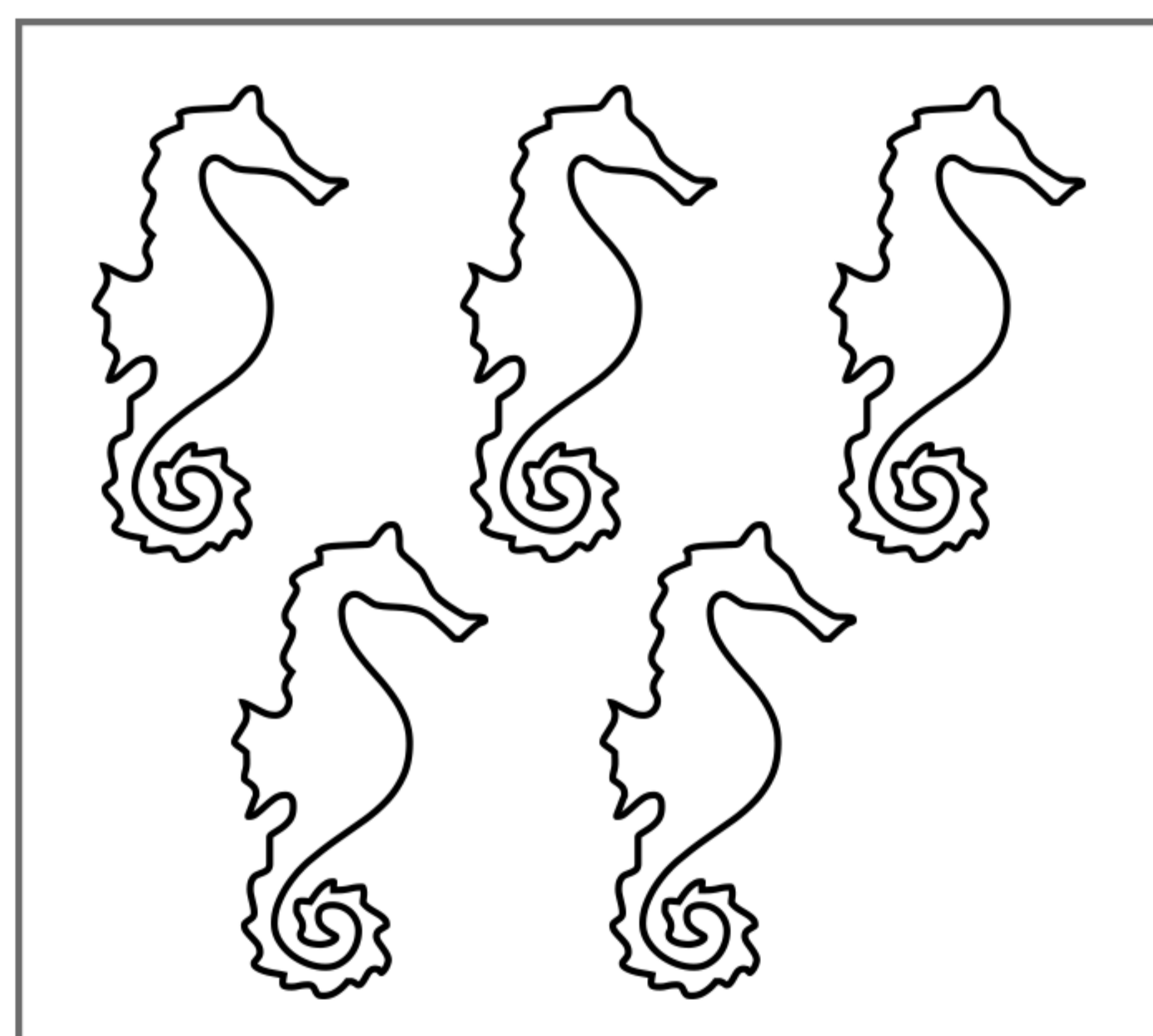
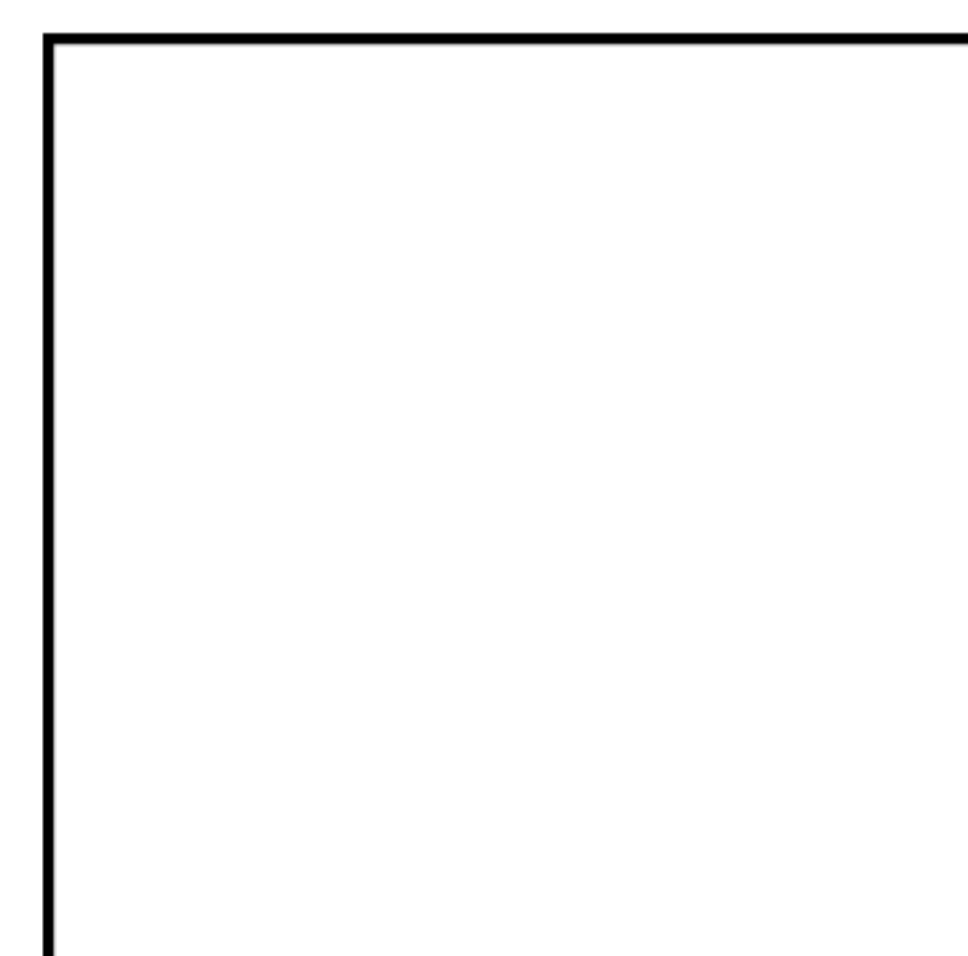

-

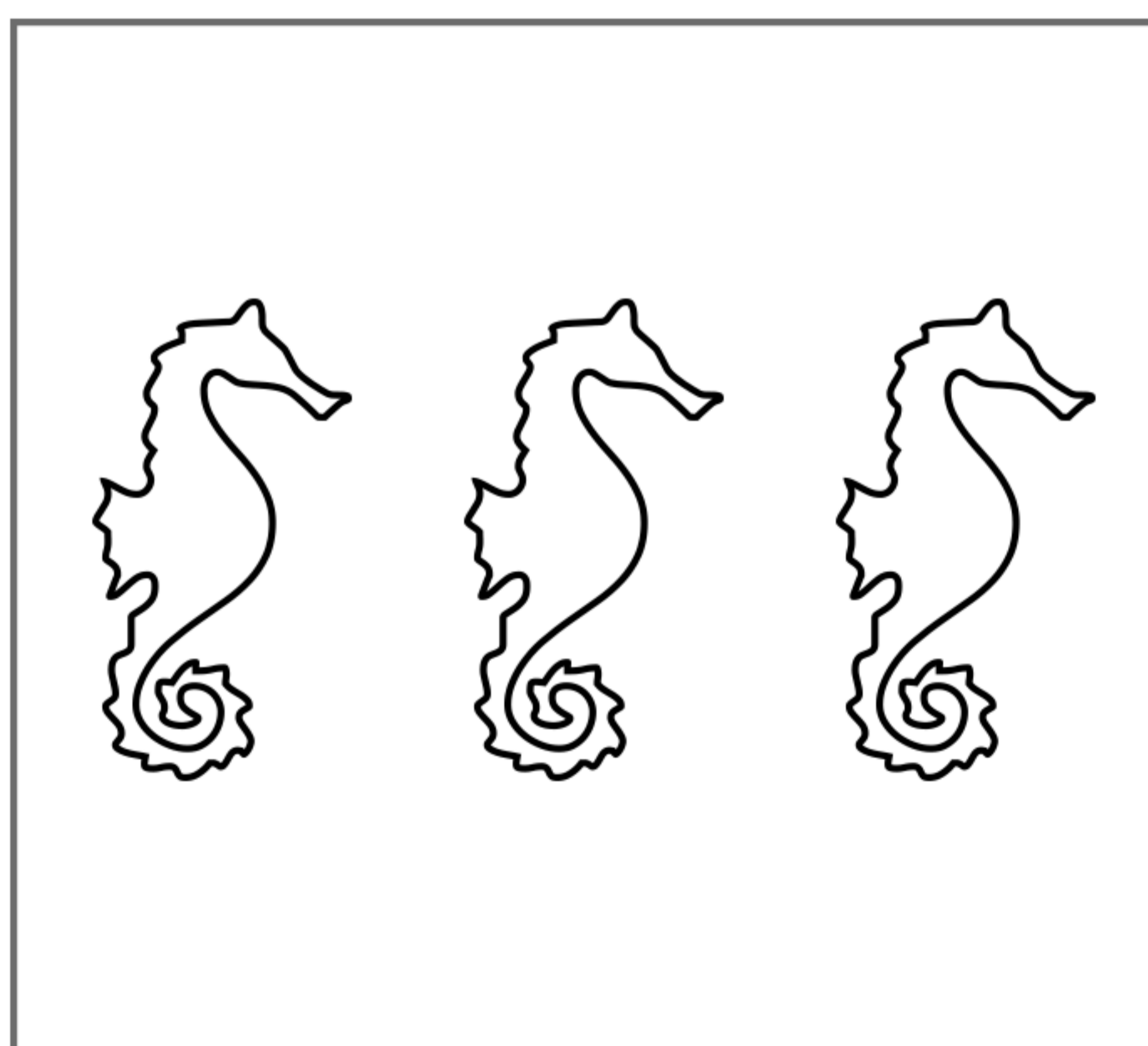

=

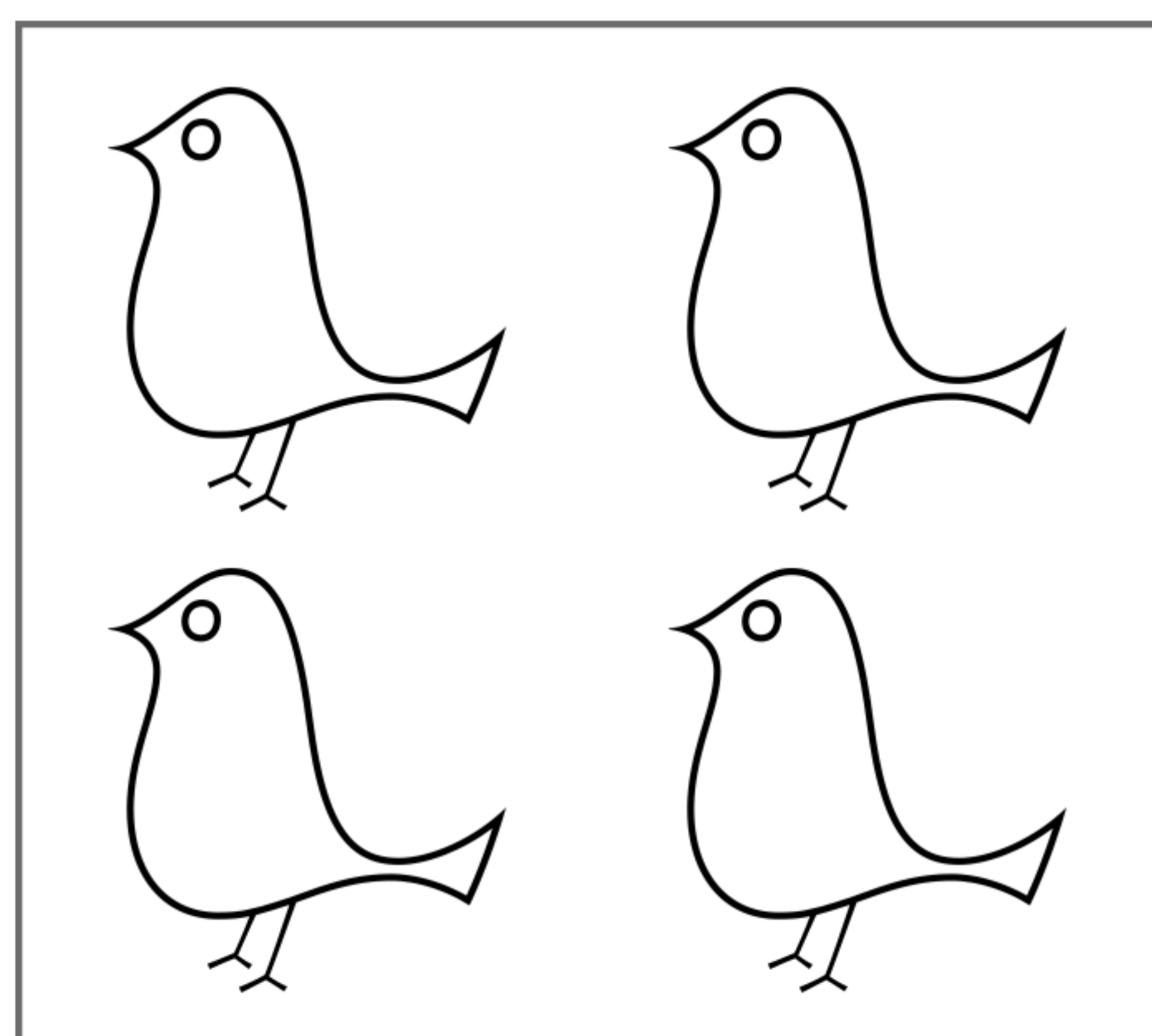
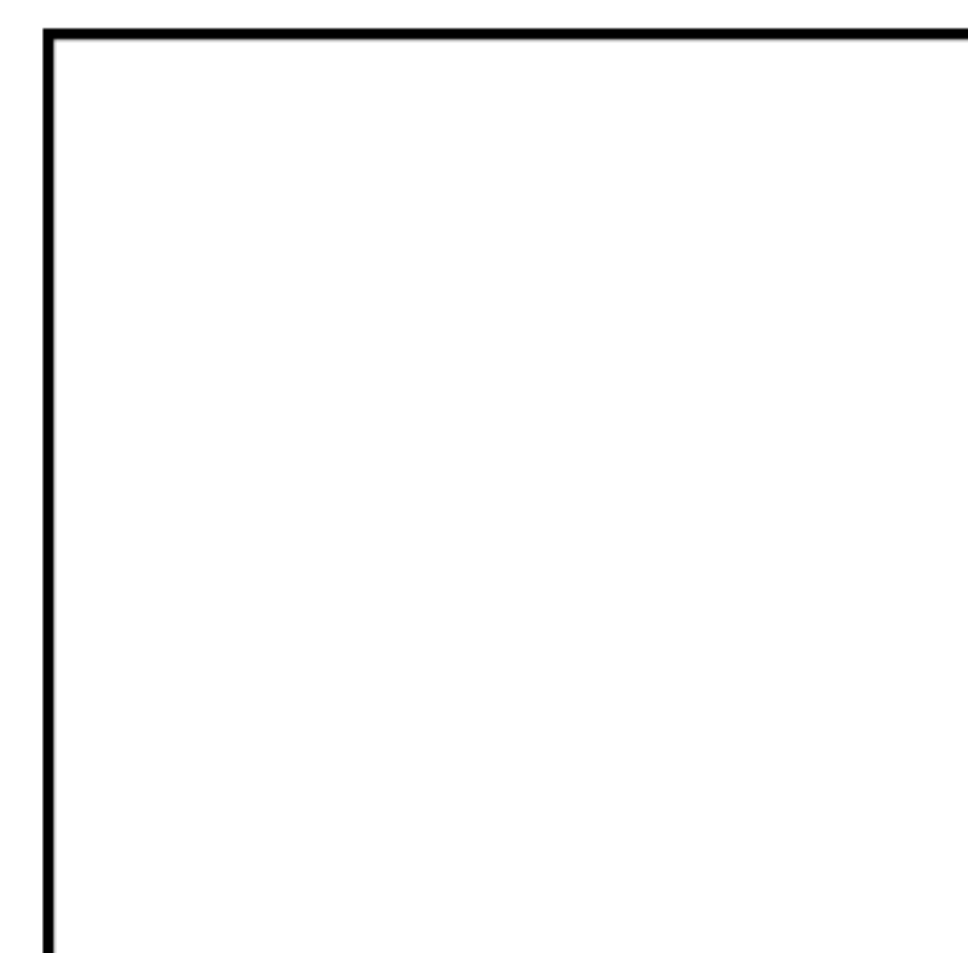

-

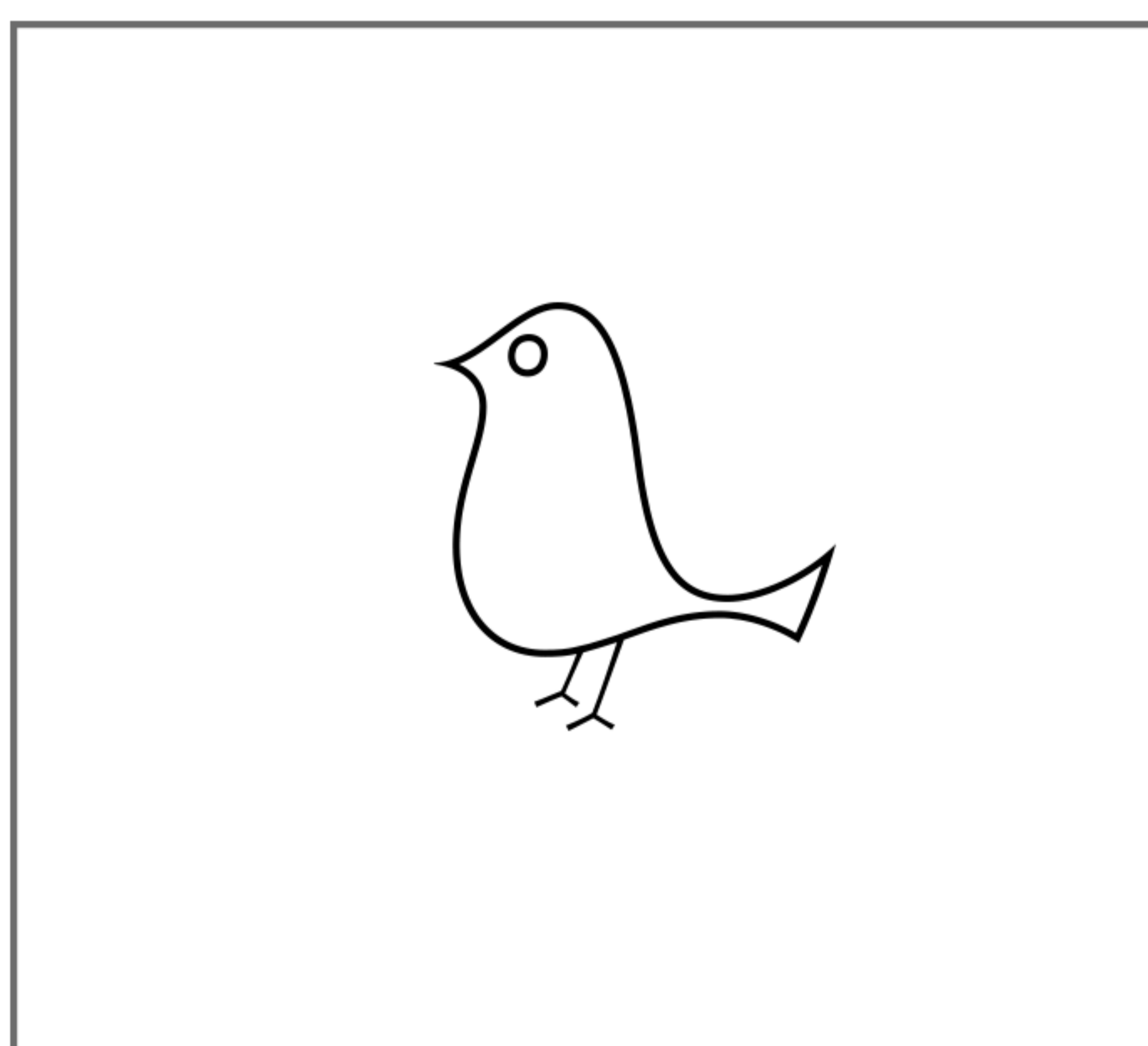

=



Sottrazioni con i disegni

- Conta, sottrai e scrivi il risultato nel riquadro di destra.

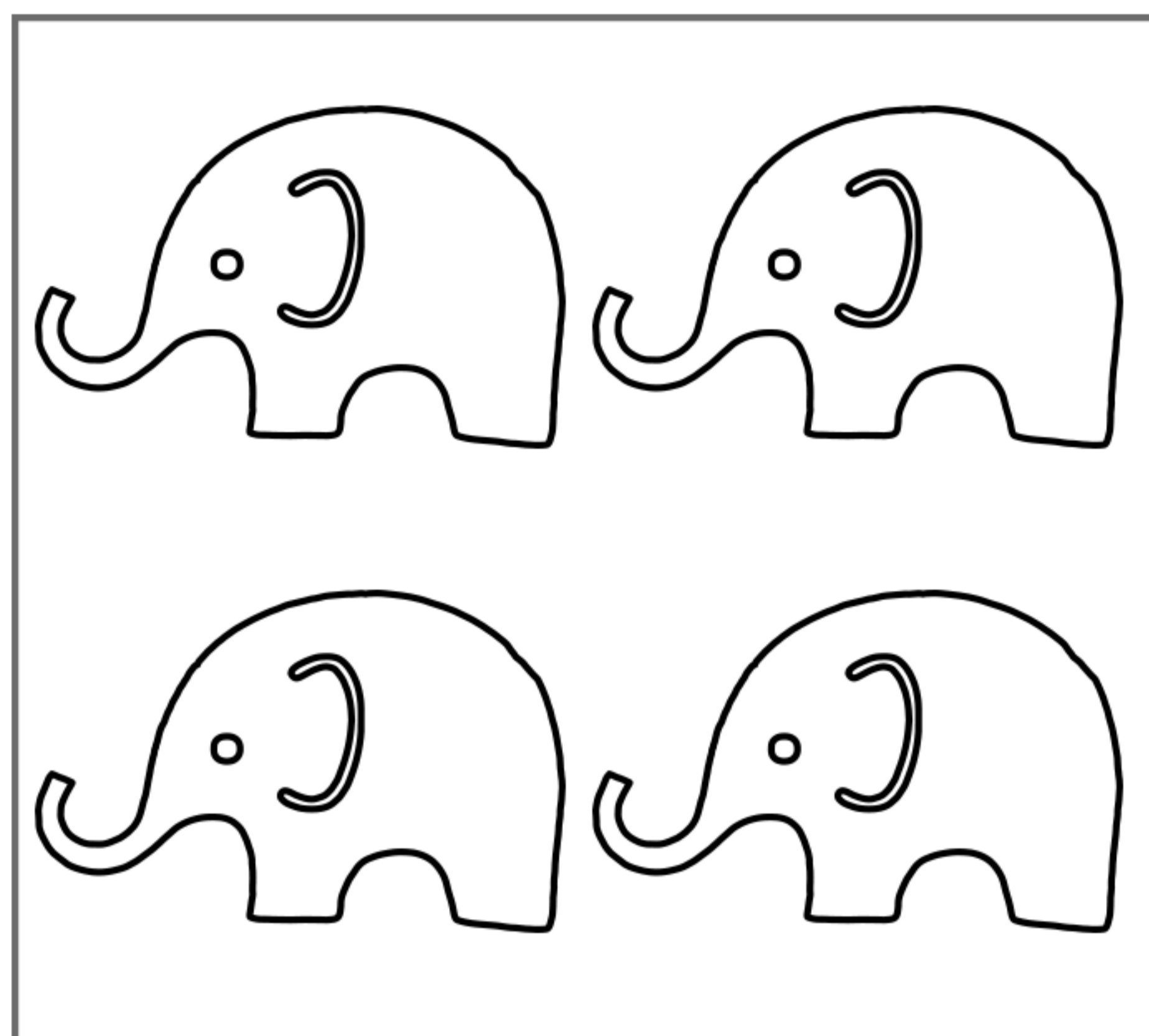

-

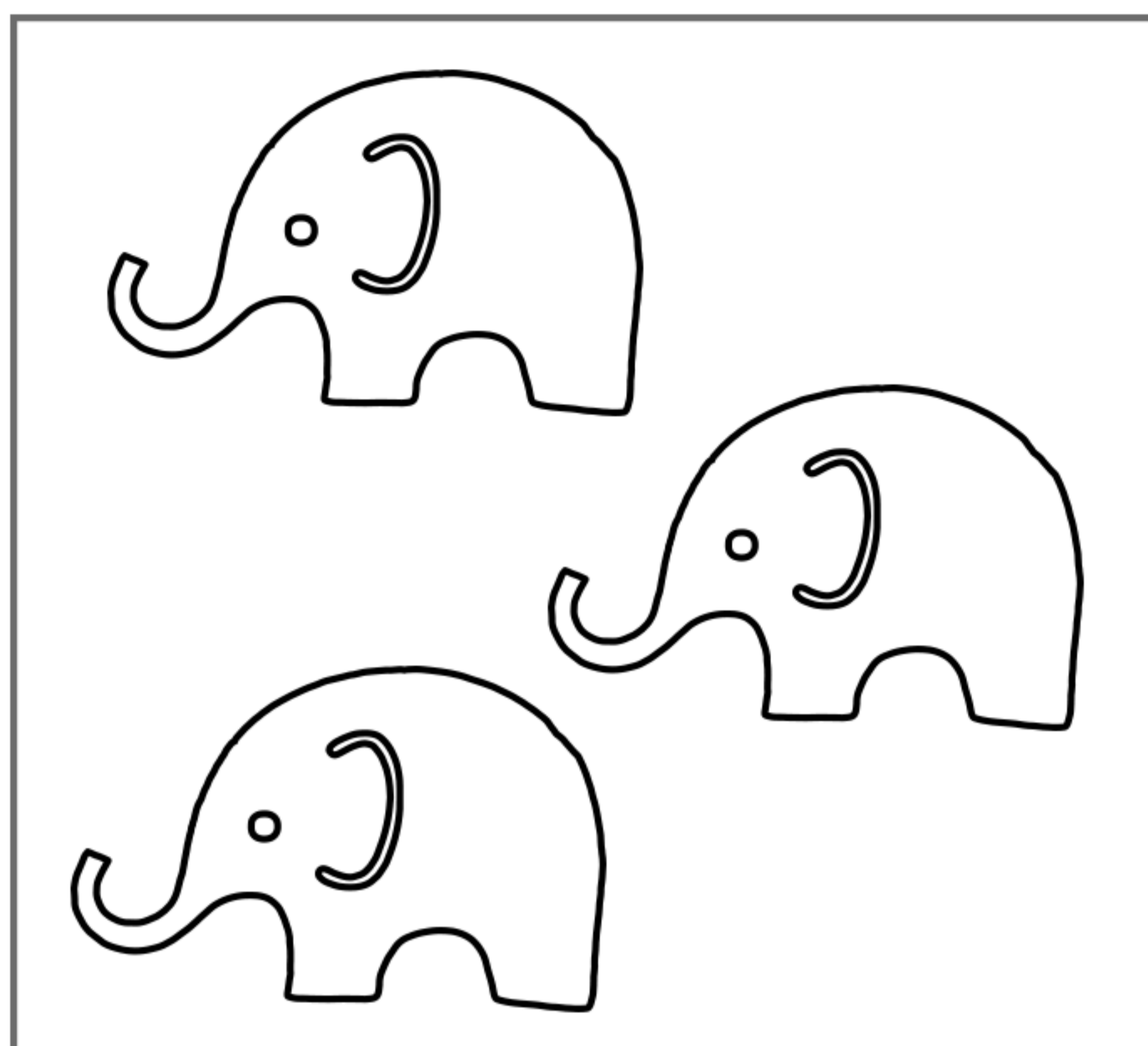

=

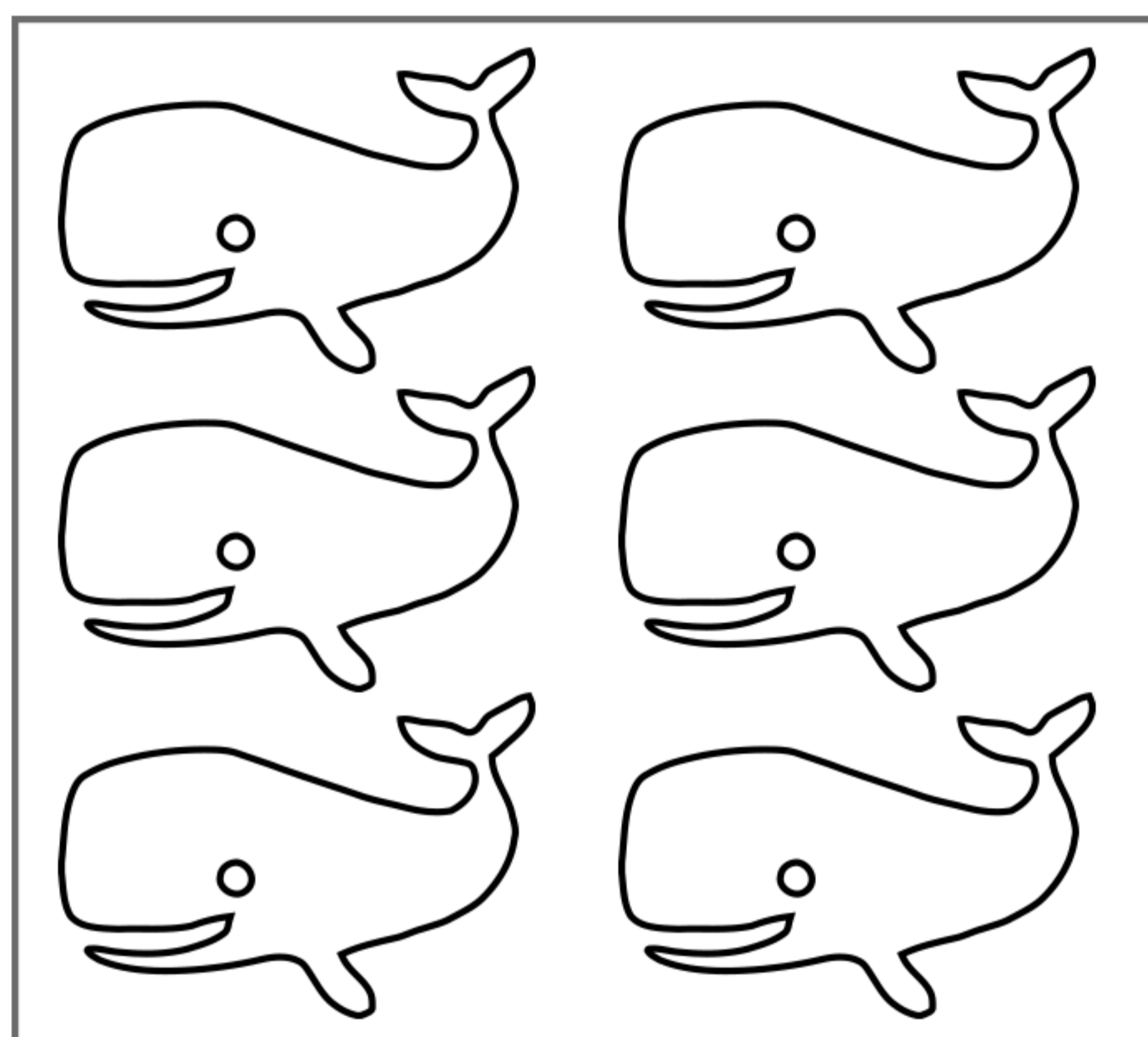
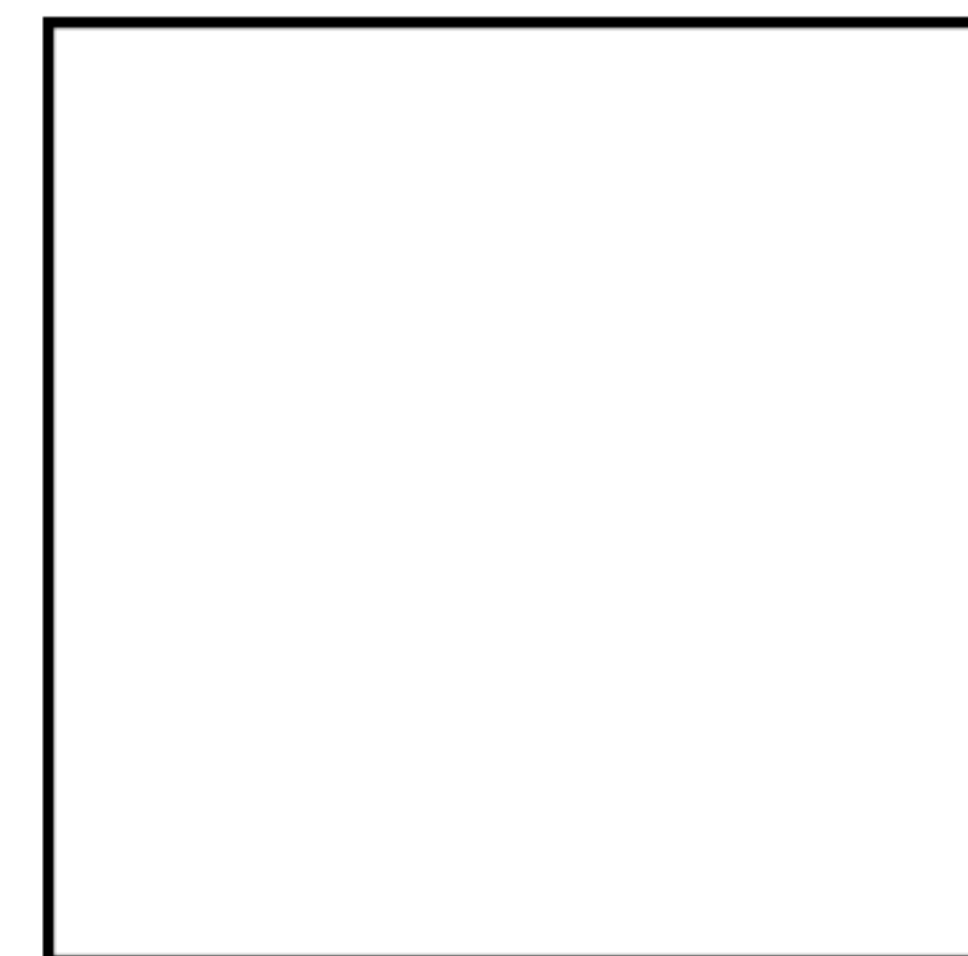

-

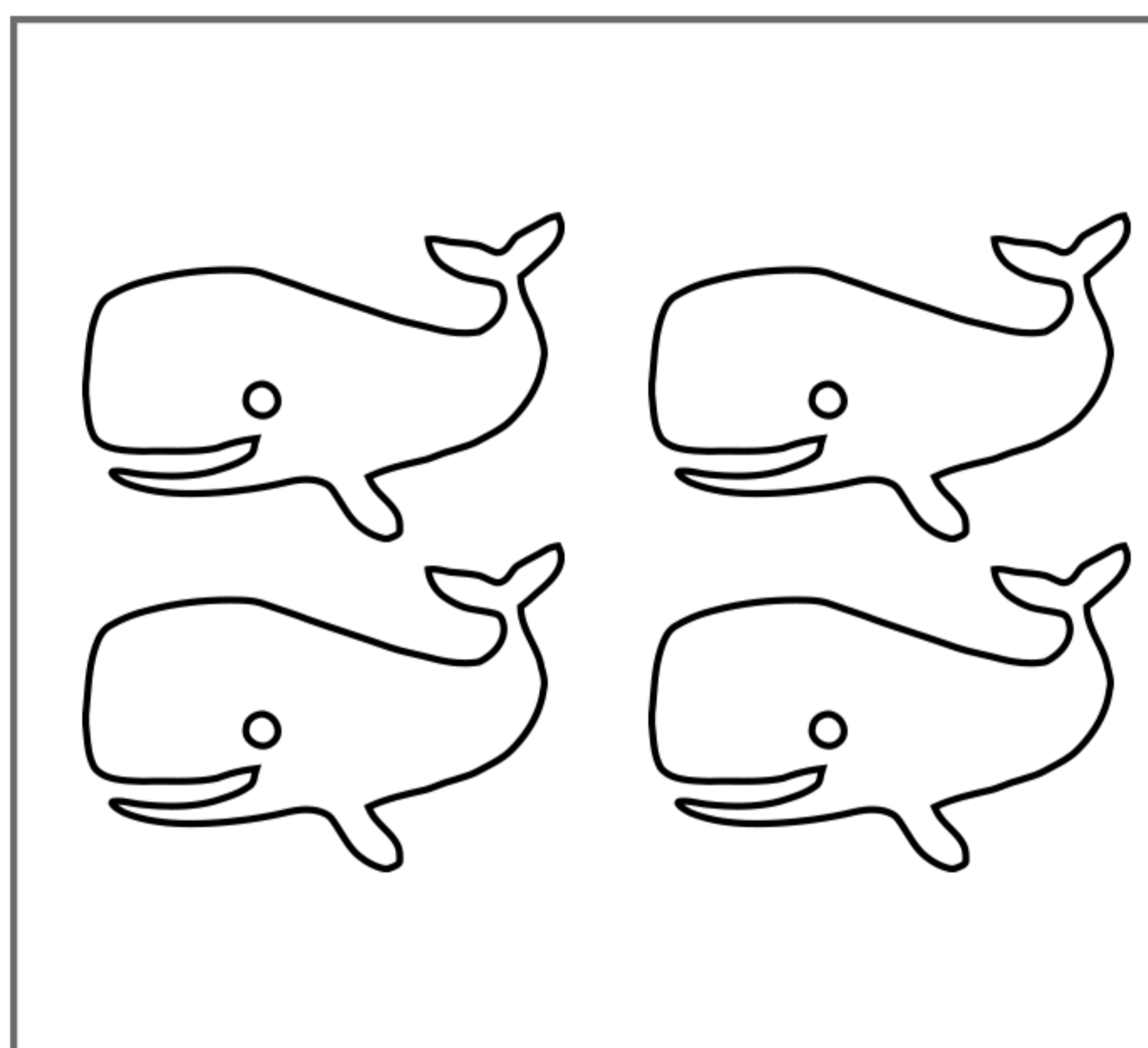

=

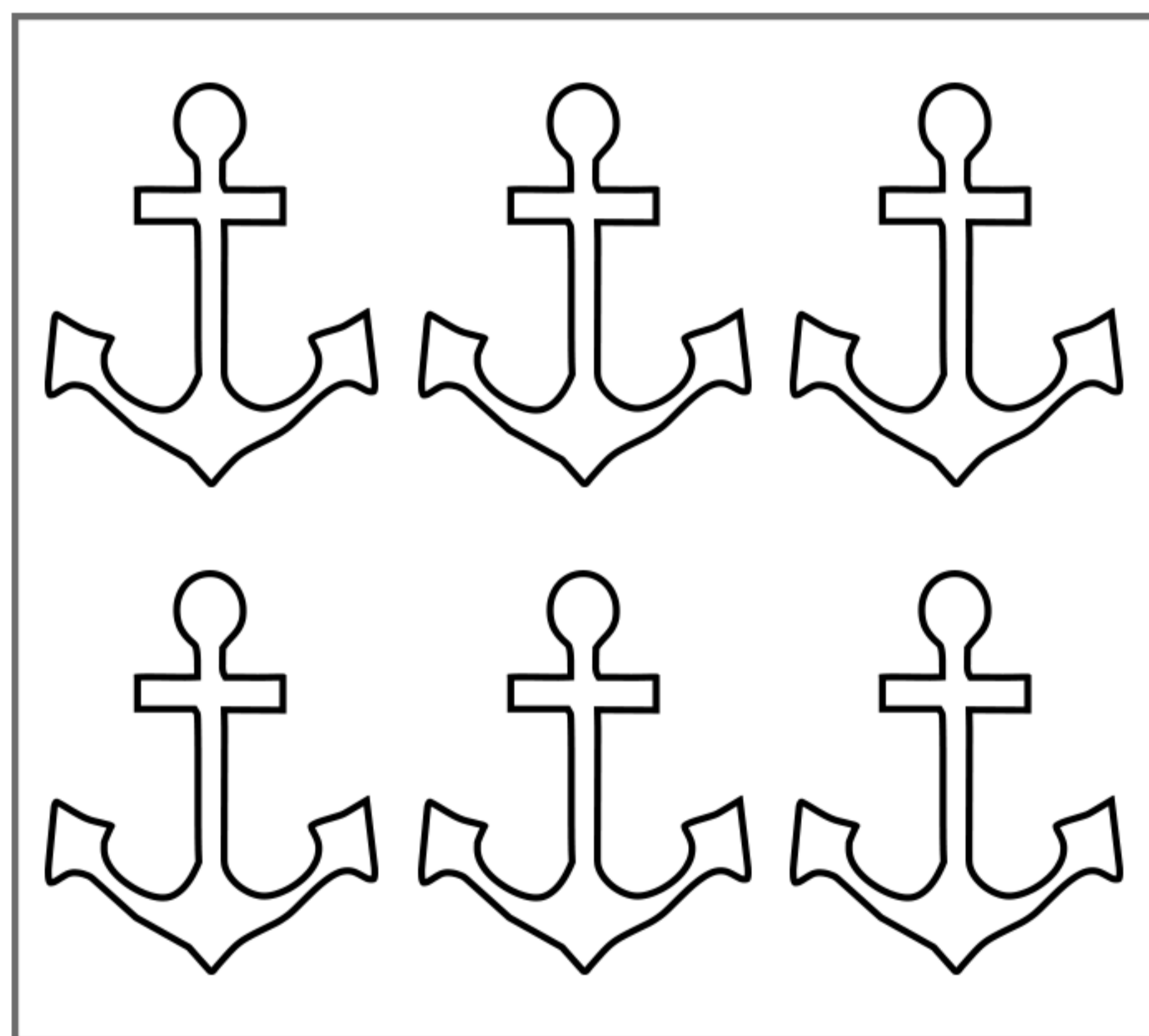
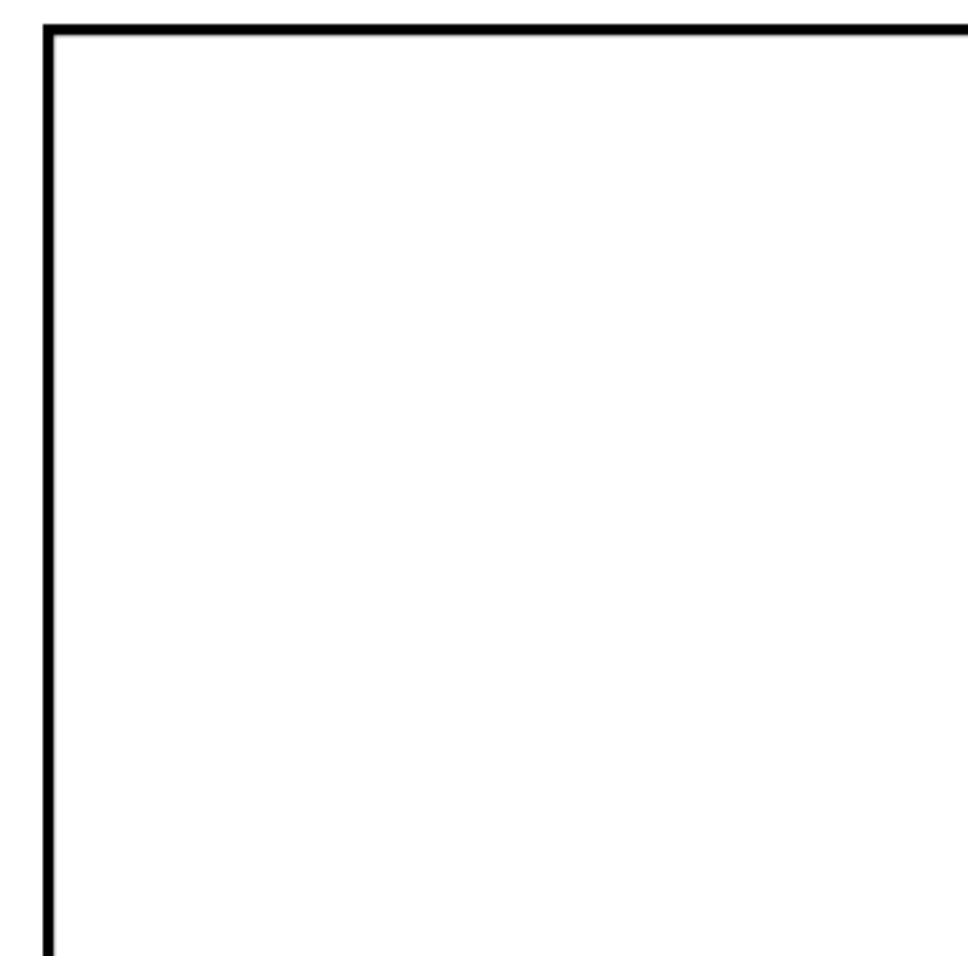

-

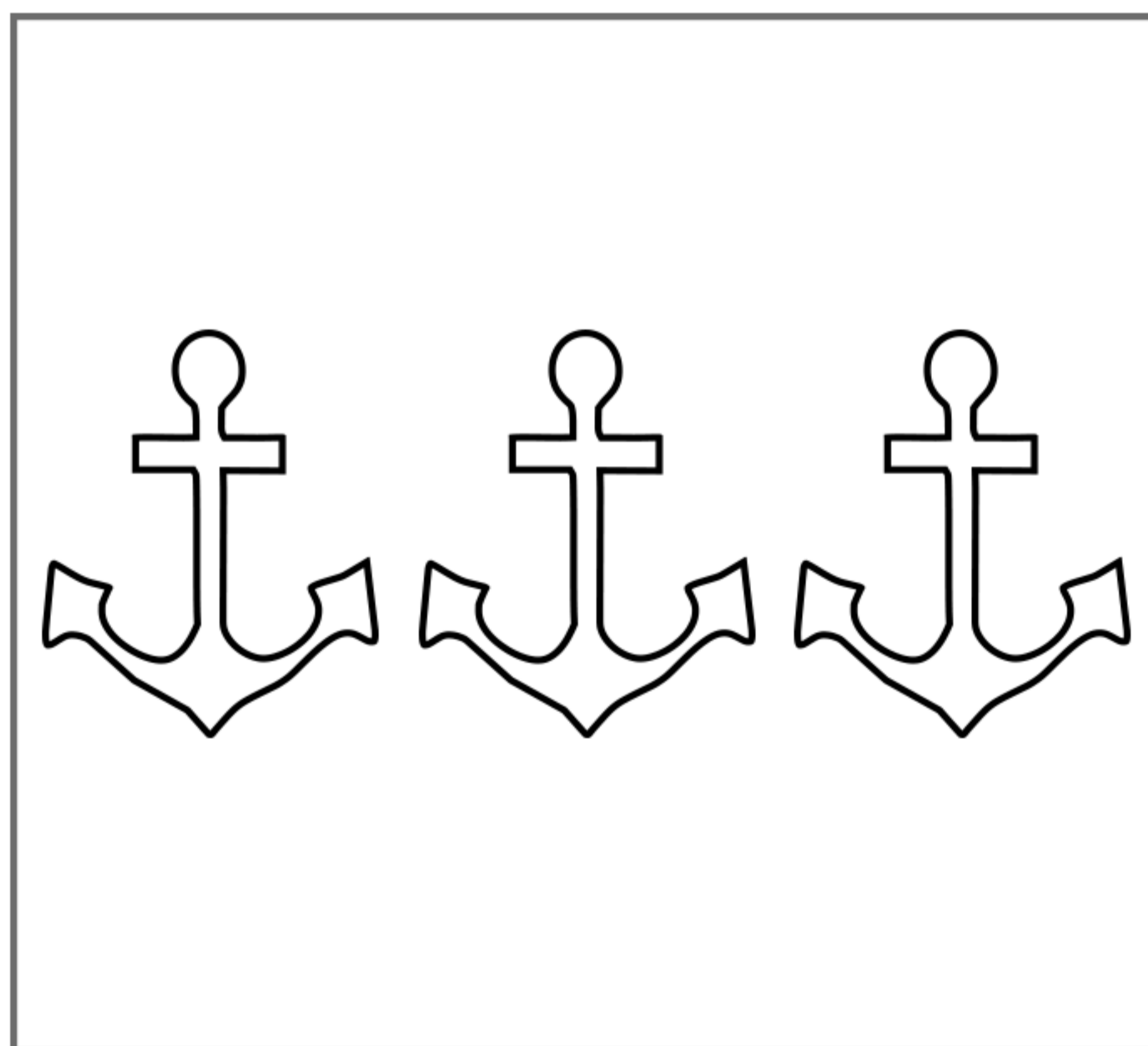

=

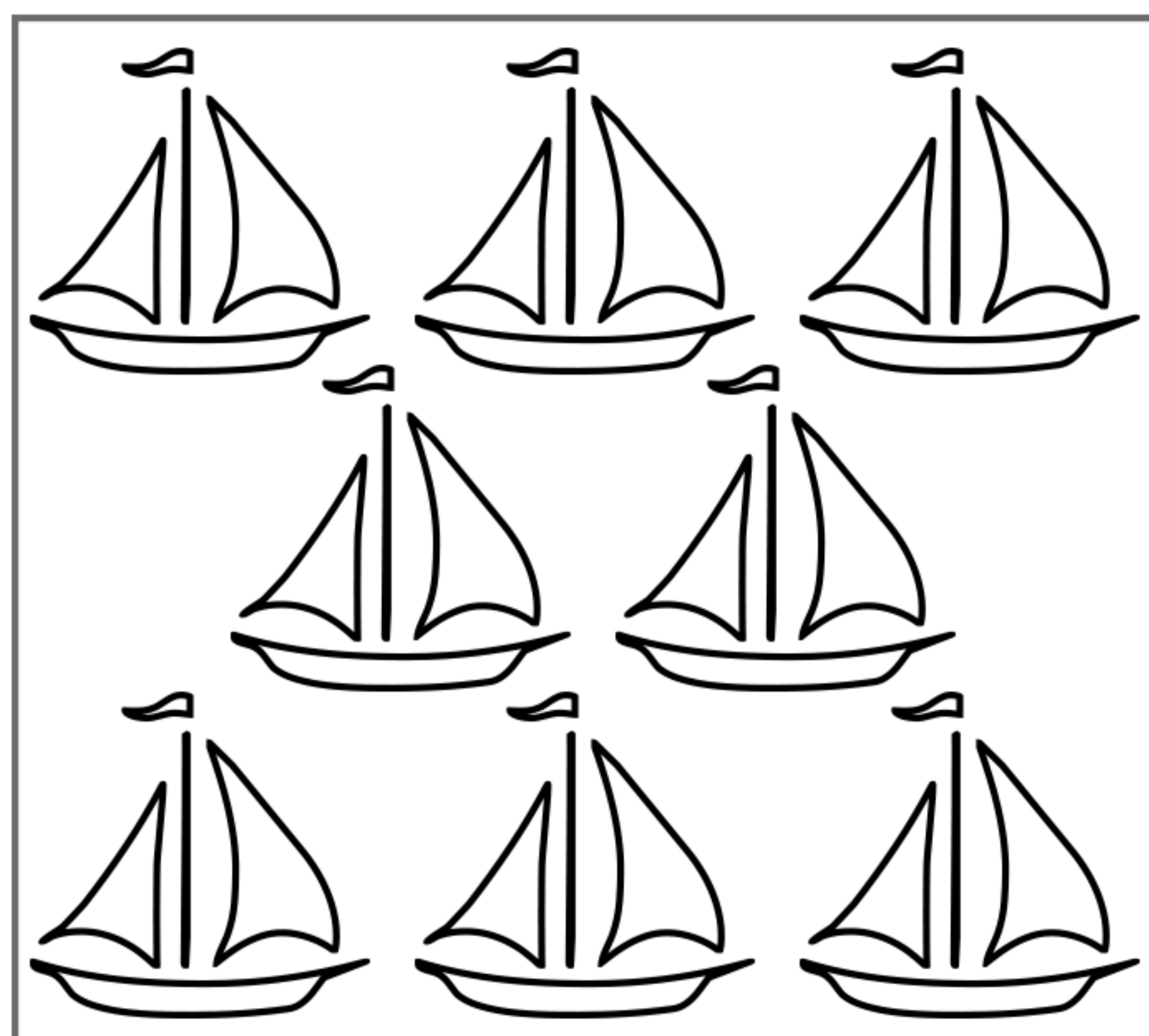
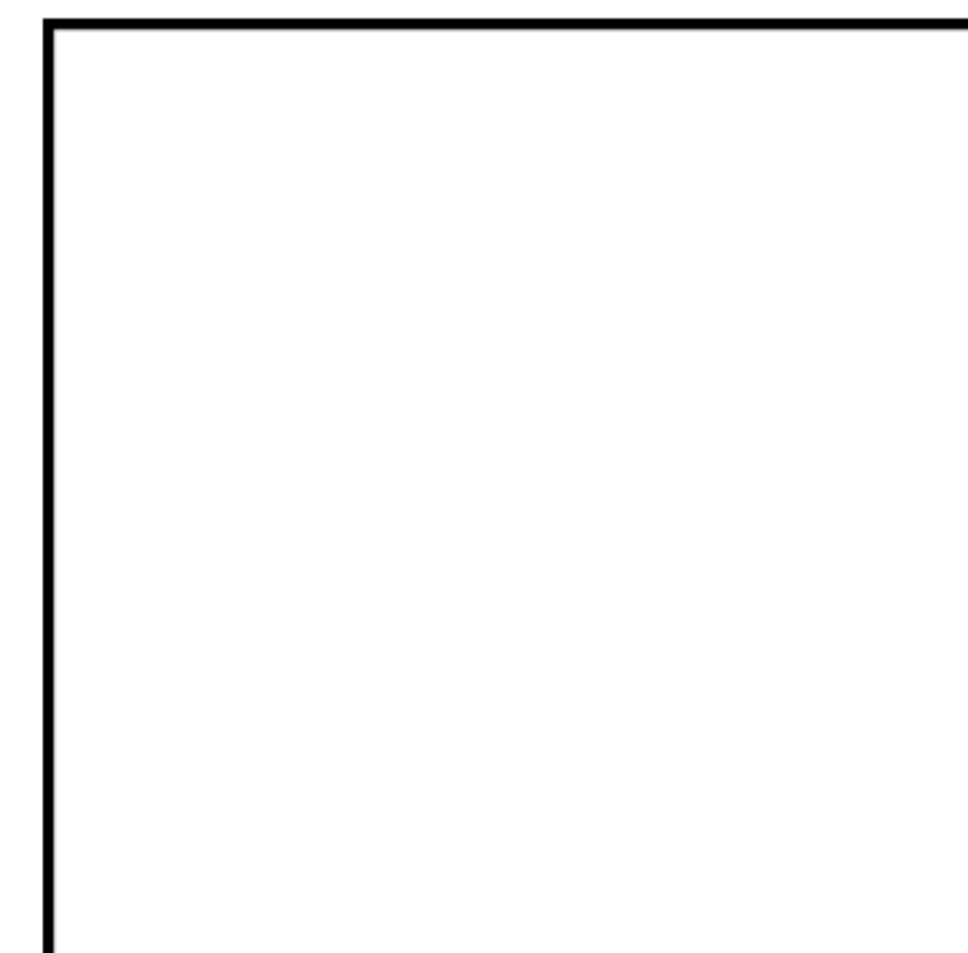

-

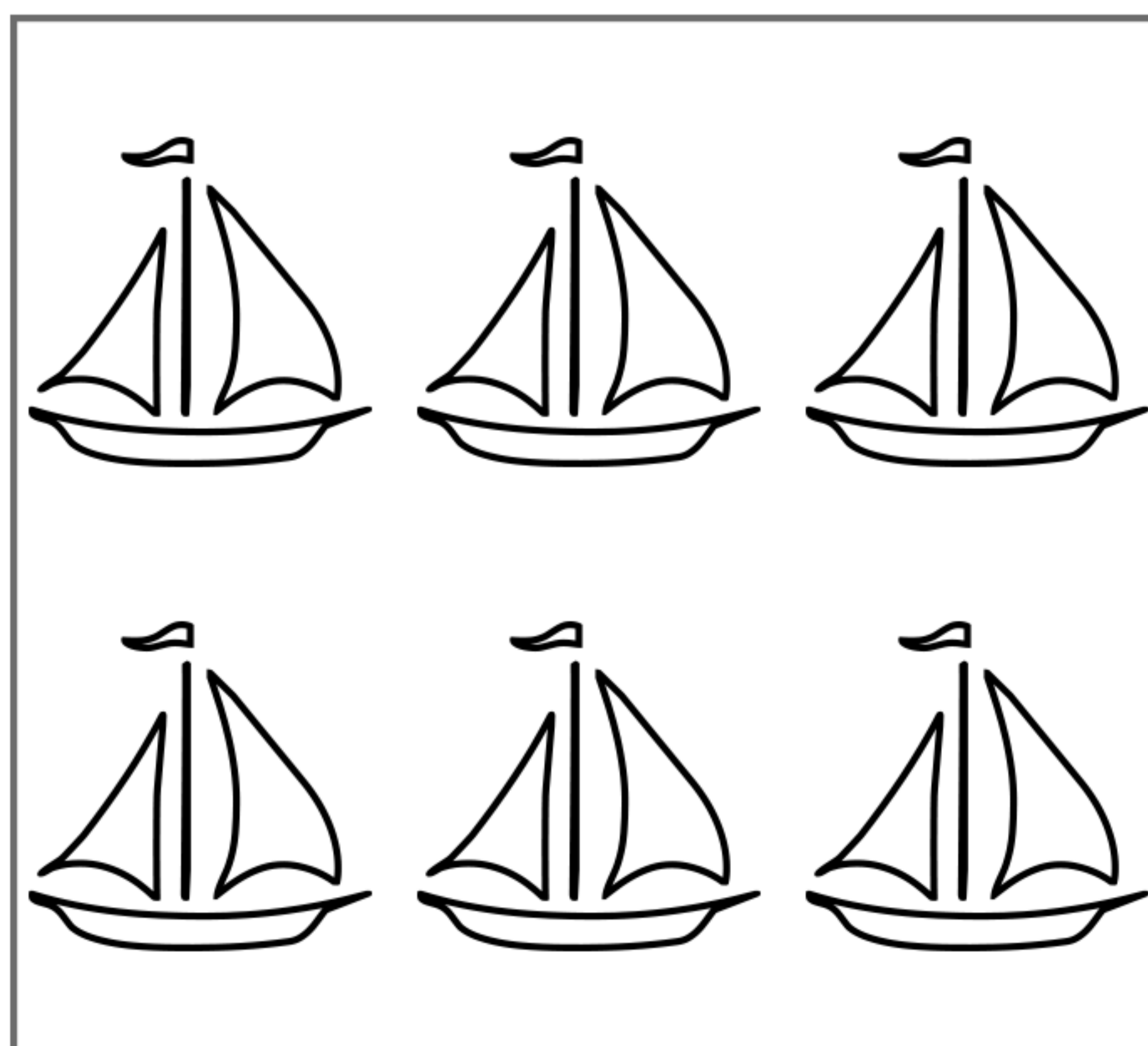

=

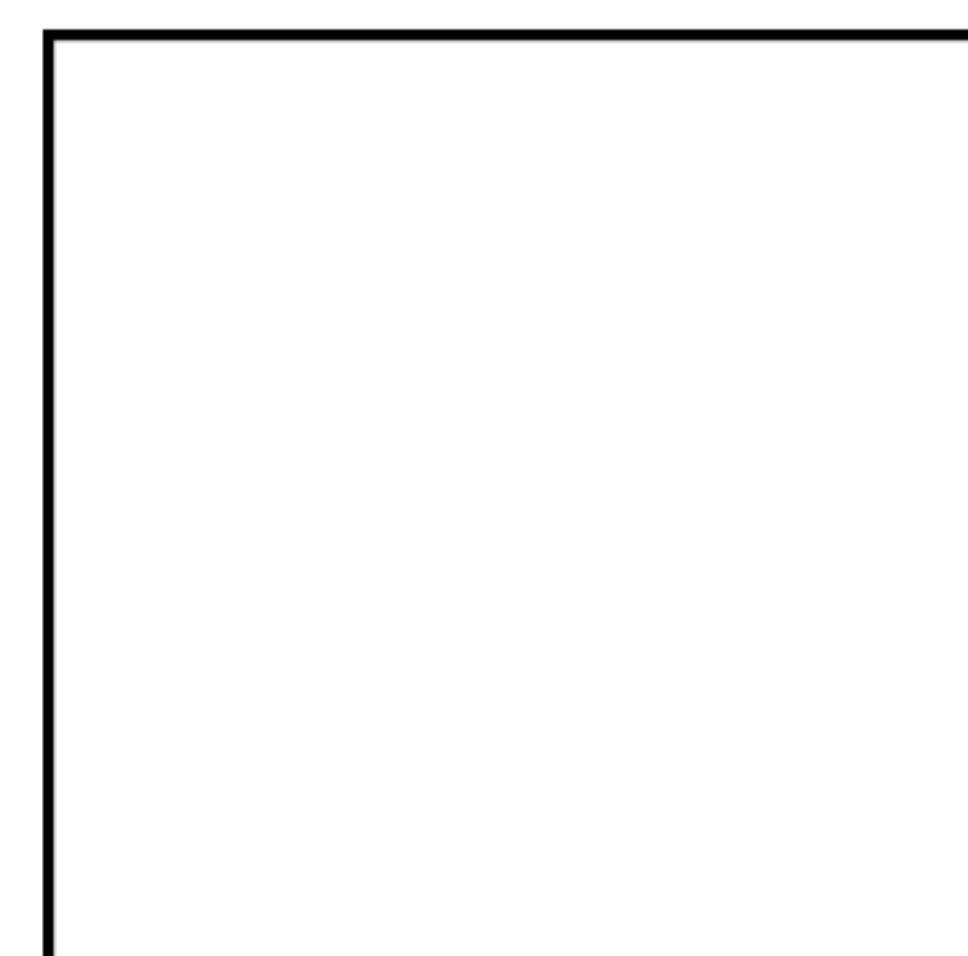

Sottrazioni con i disegni

- Conta, sottrai e scrivi il risultato nel riquadro di destra.

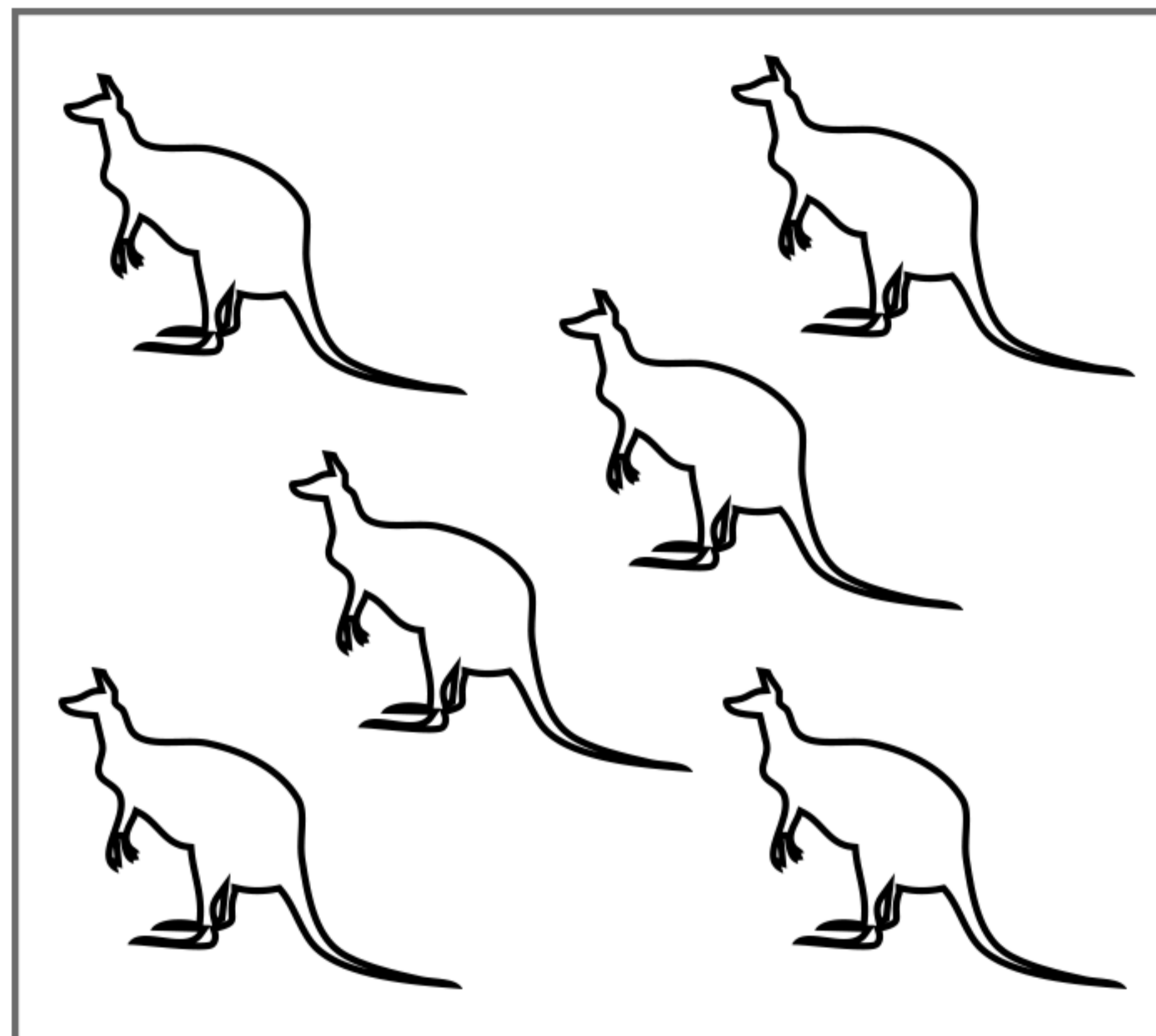

-

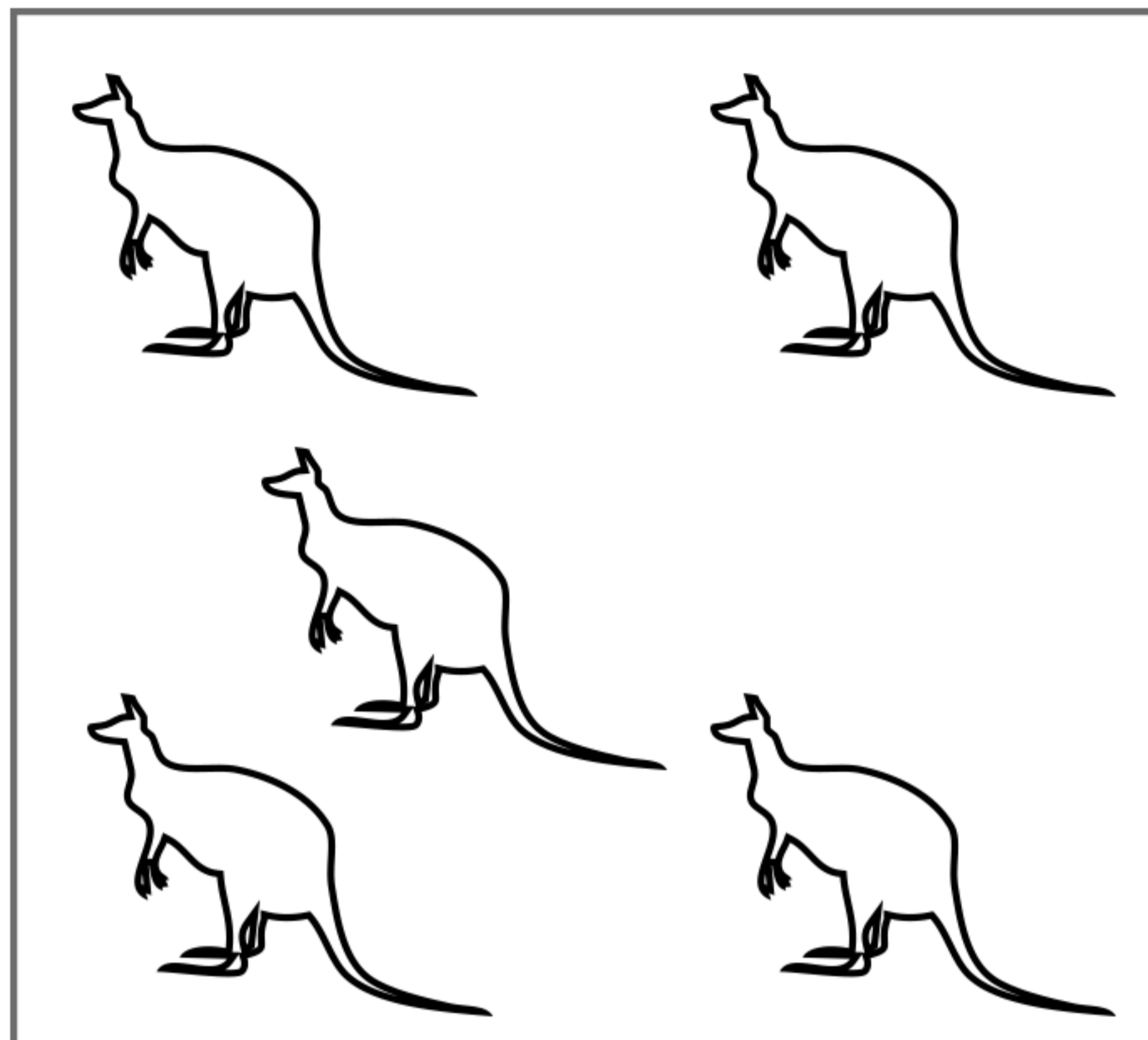

=

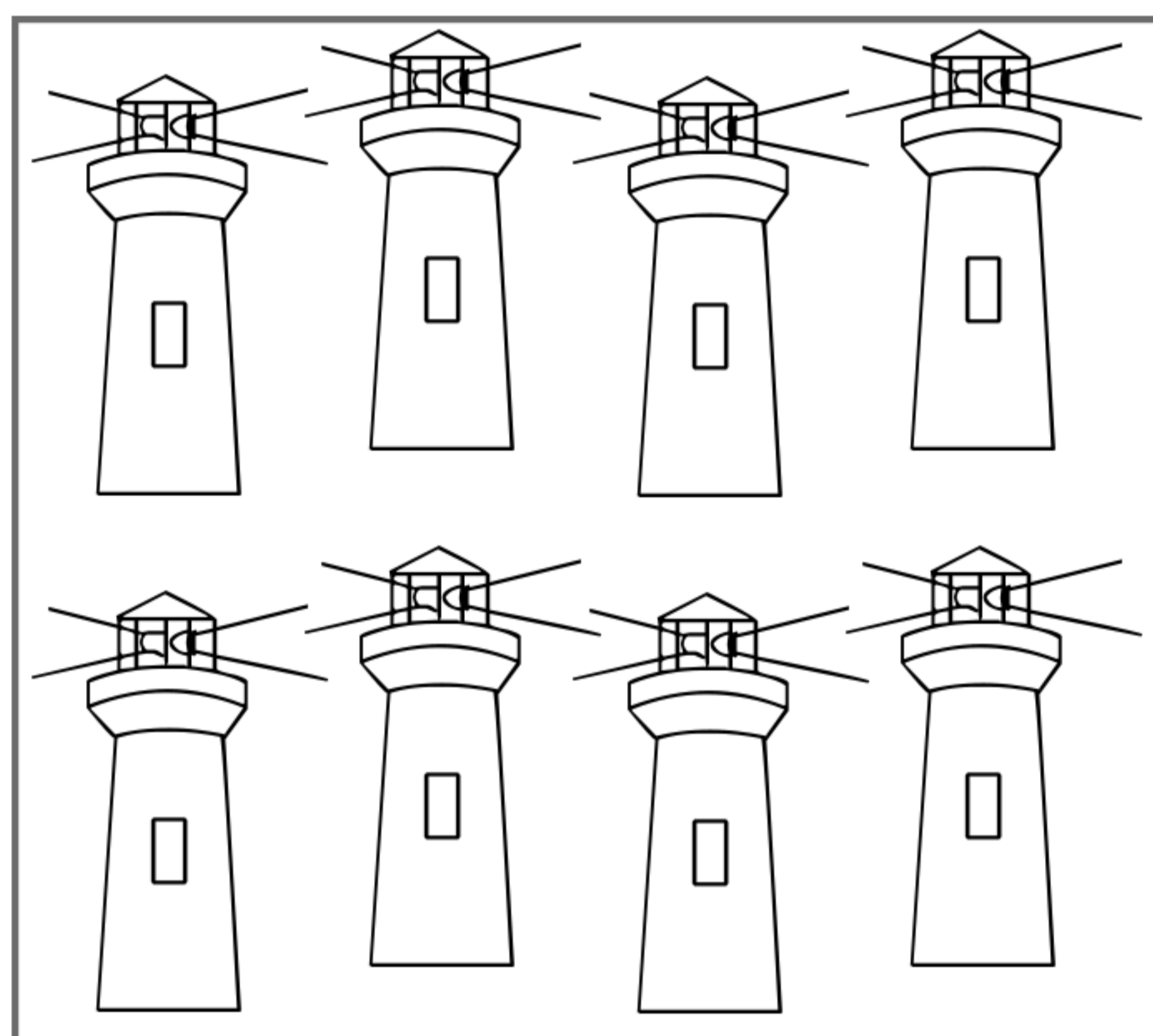
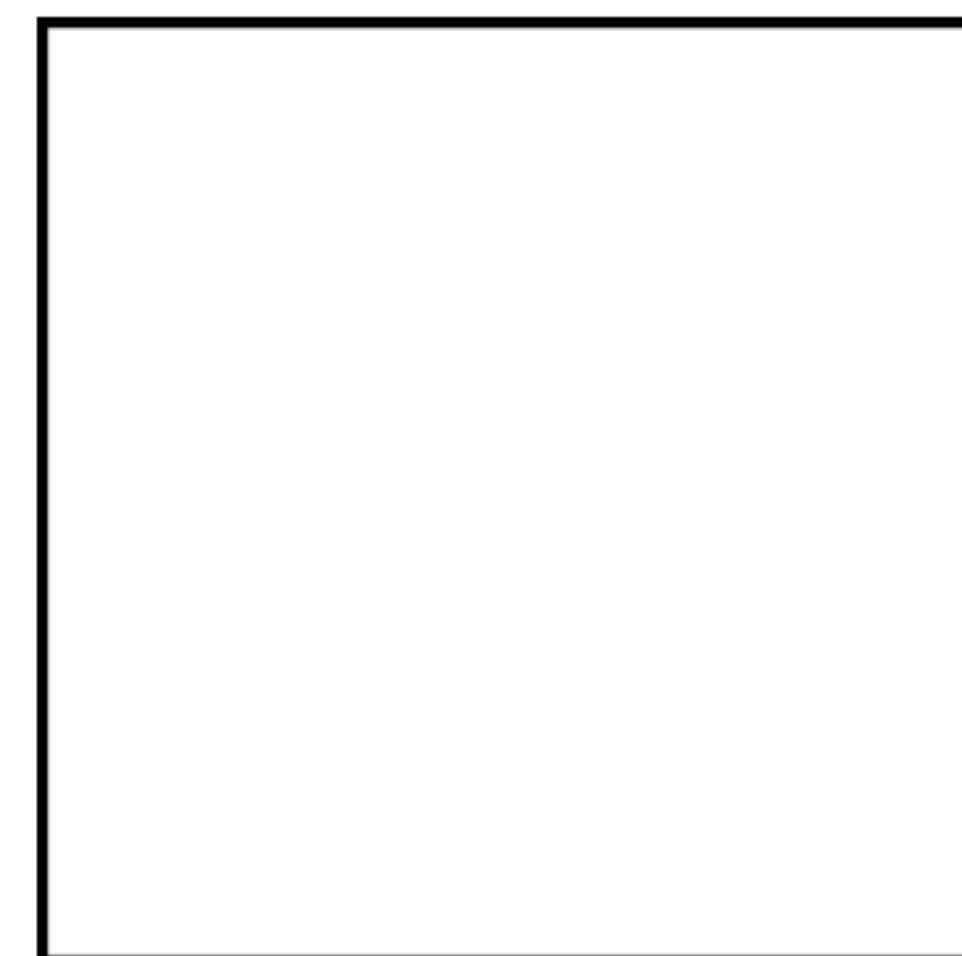

-

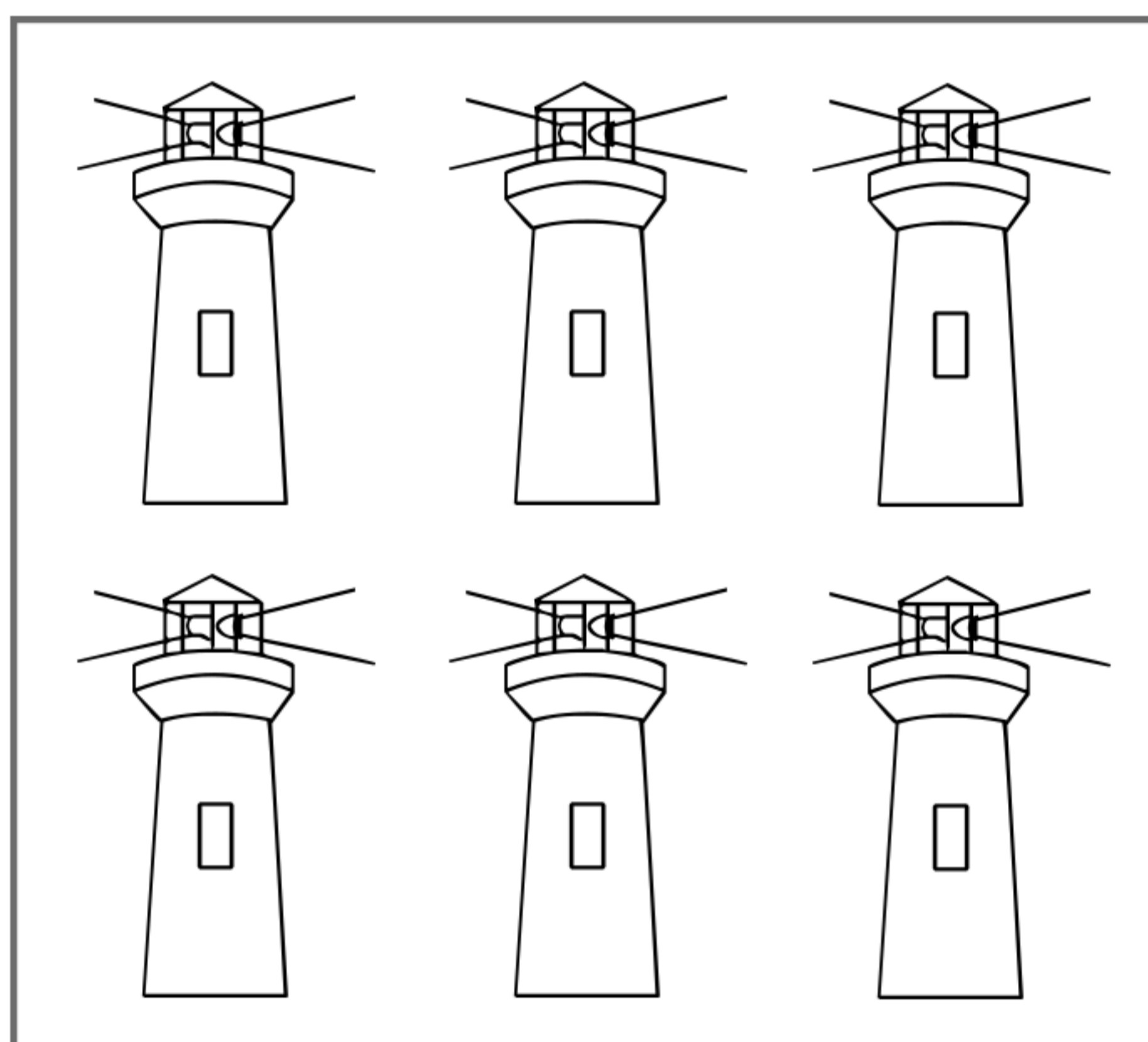

=

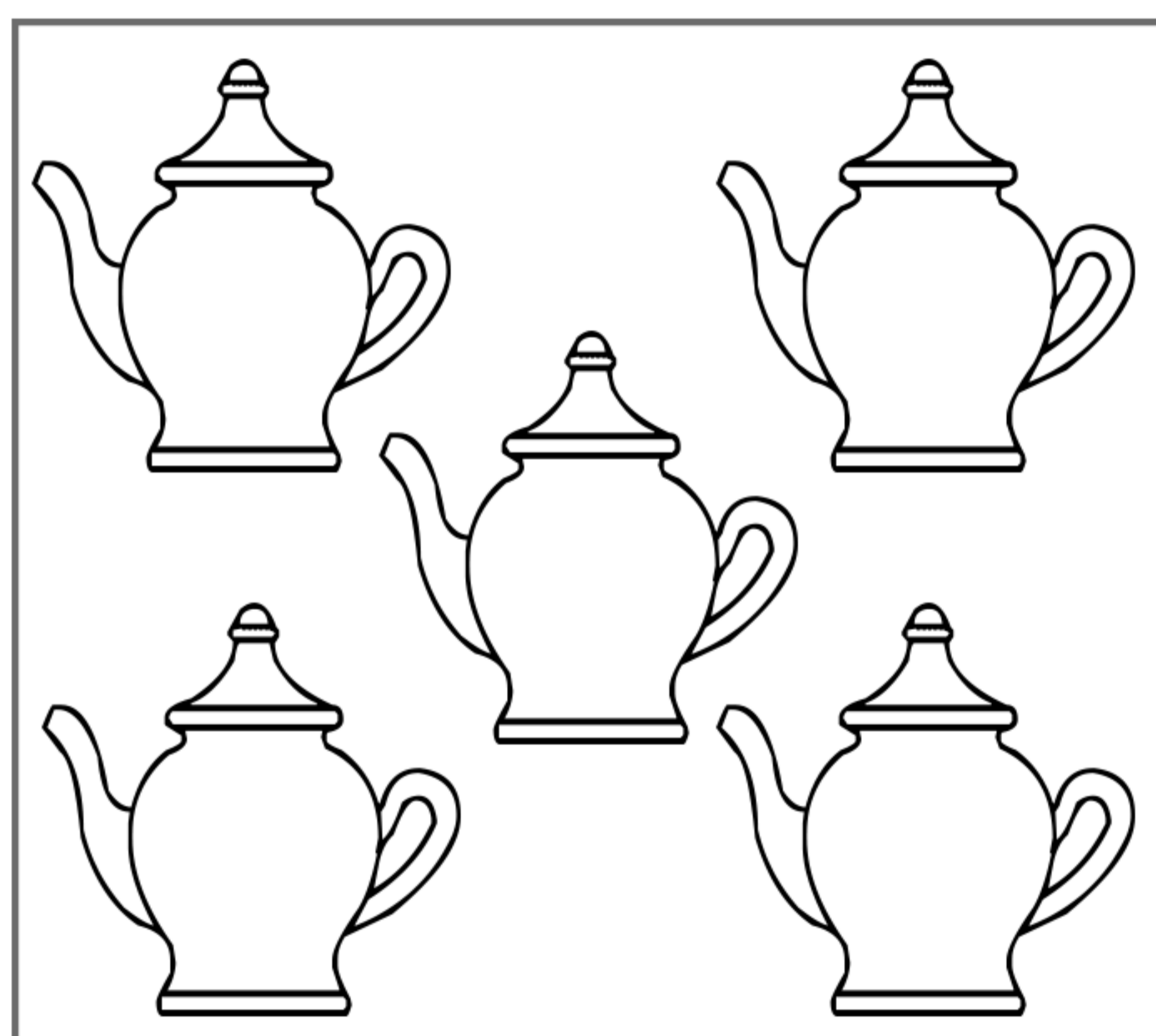
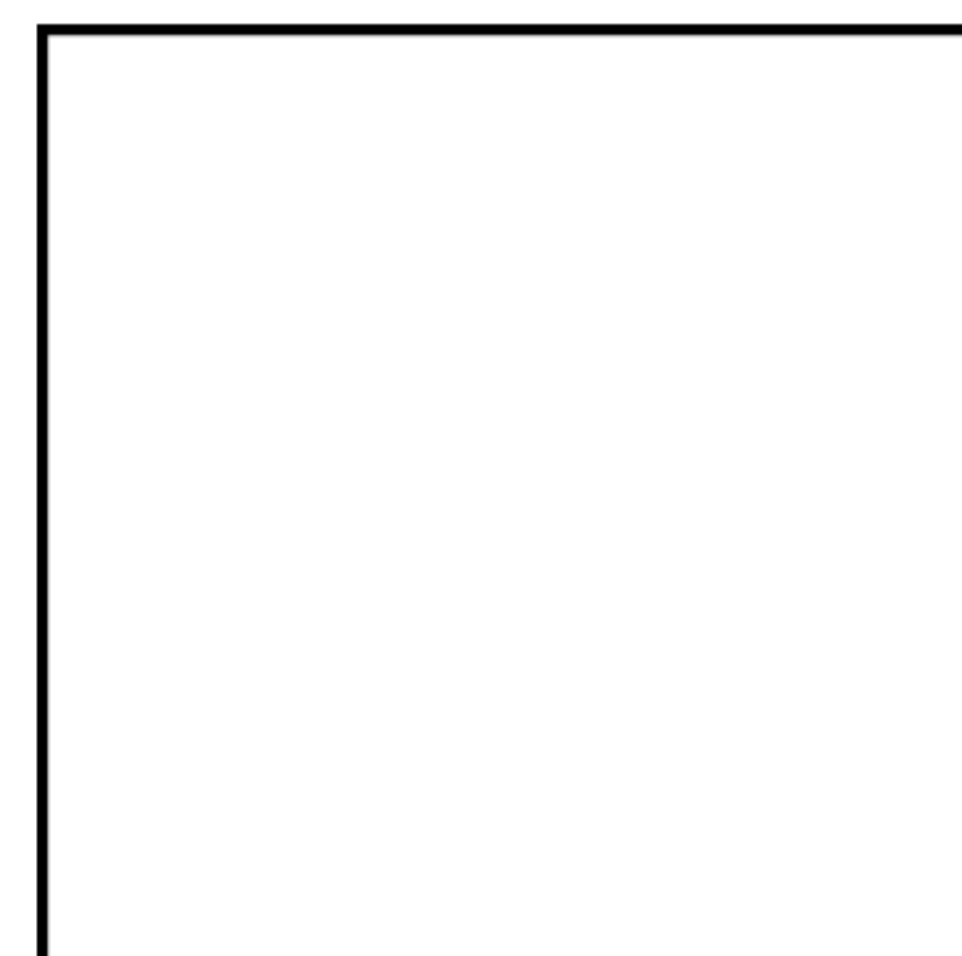

-

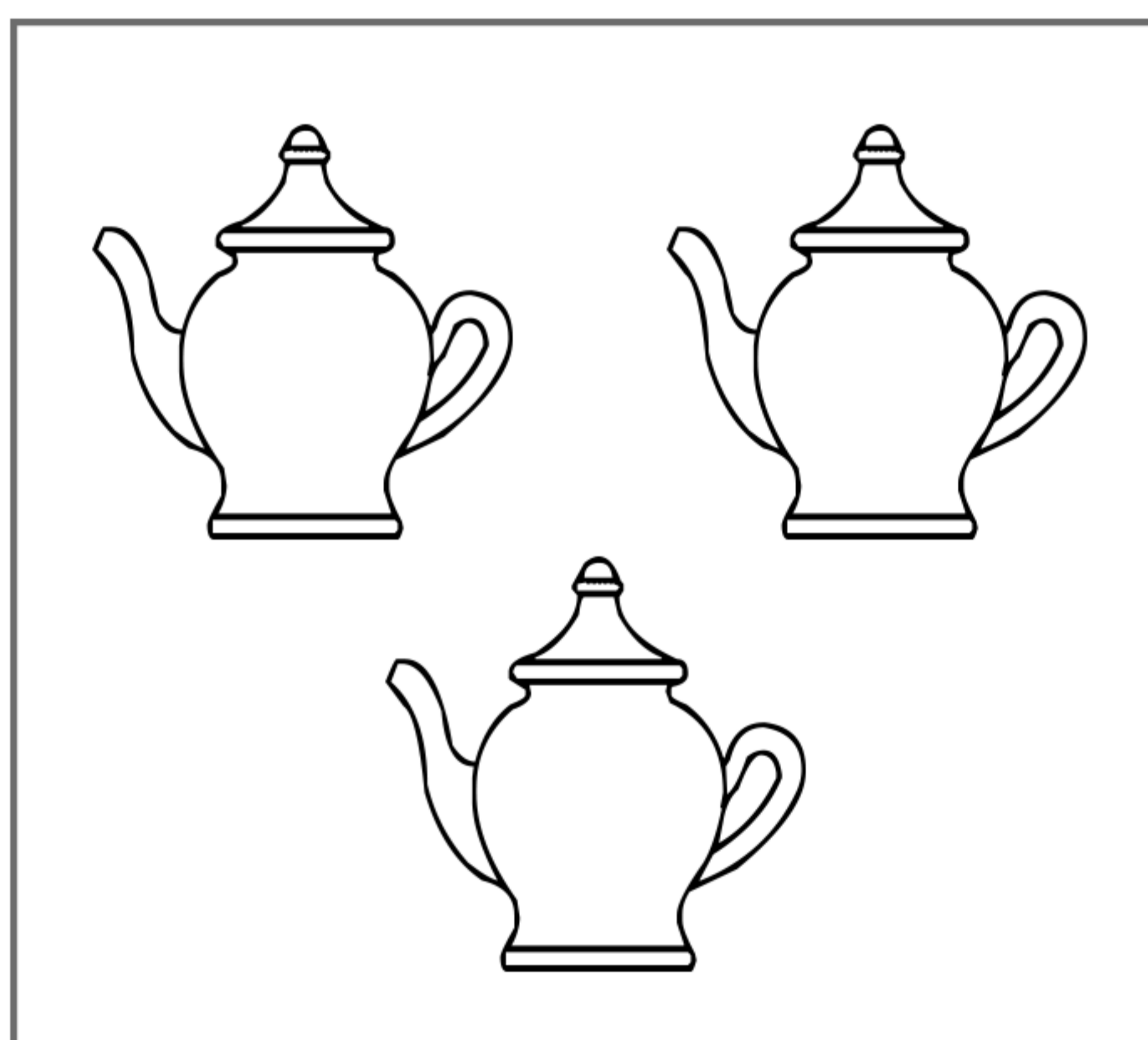

=

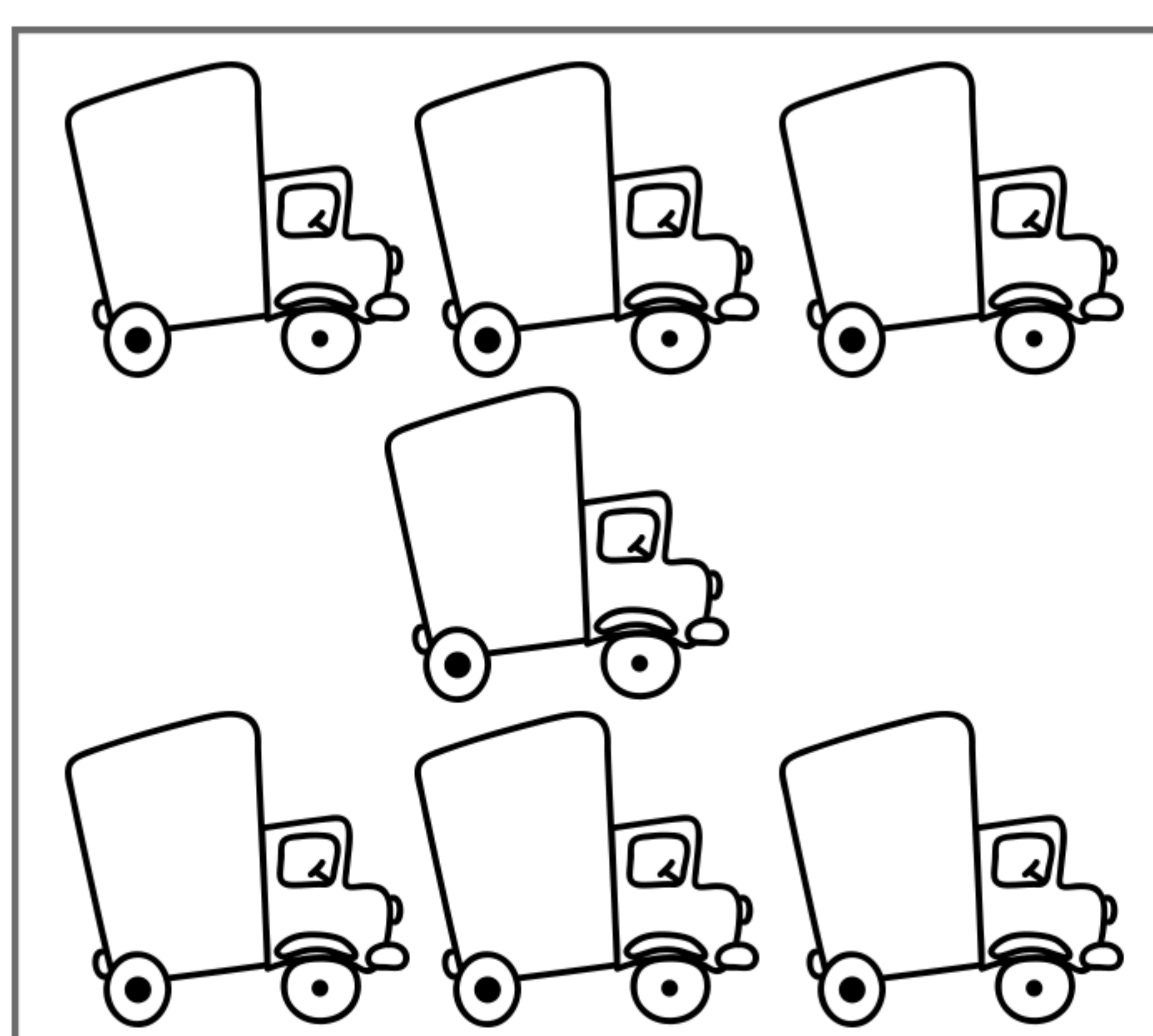
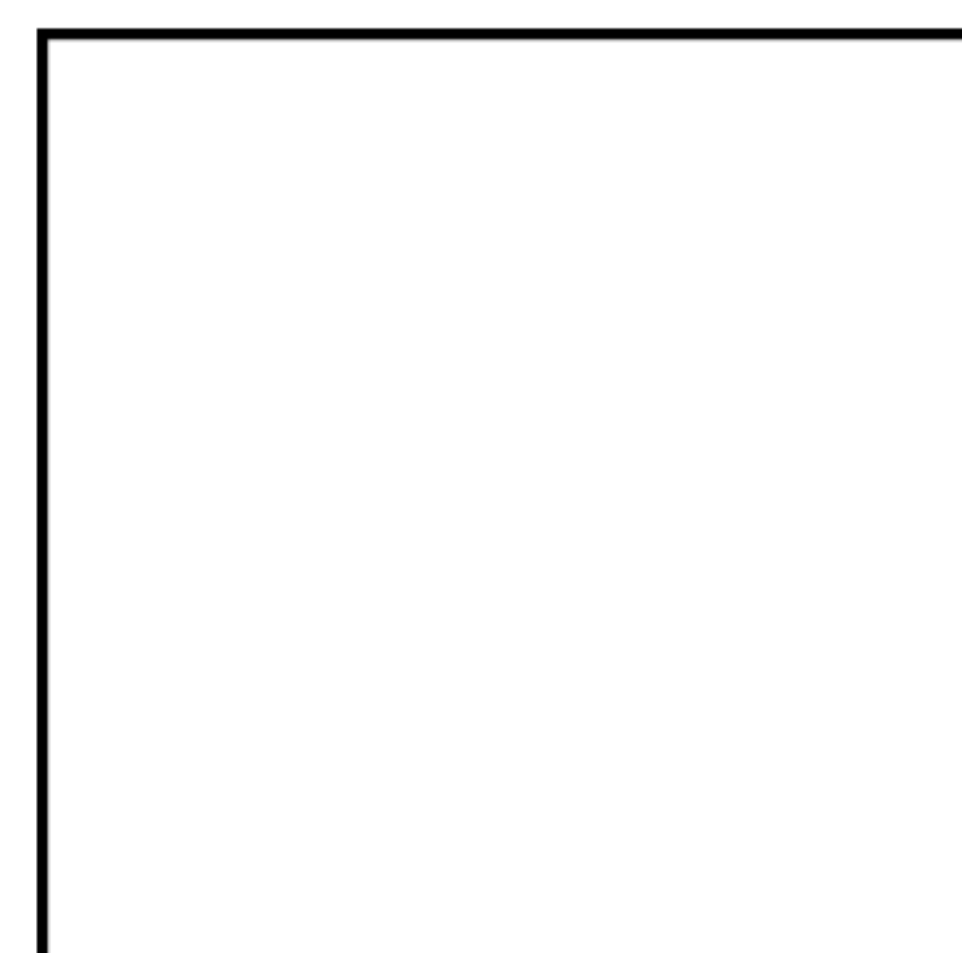

-

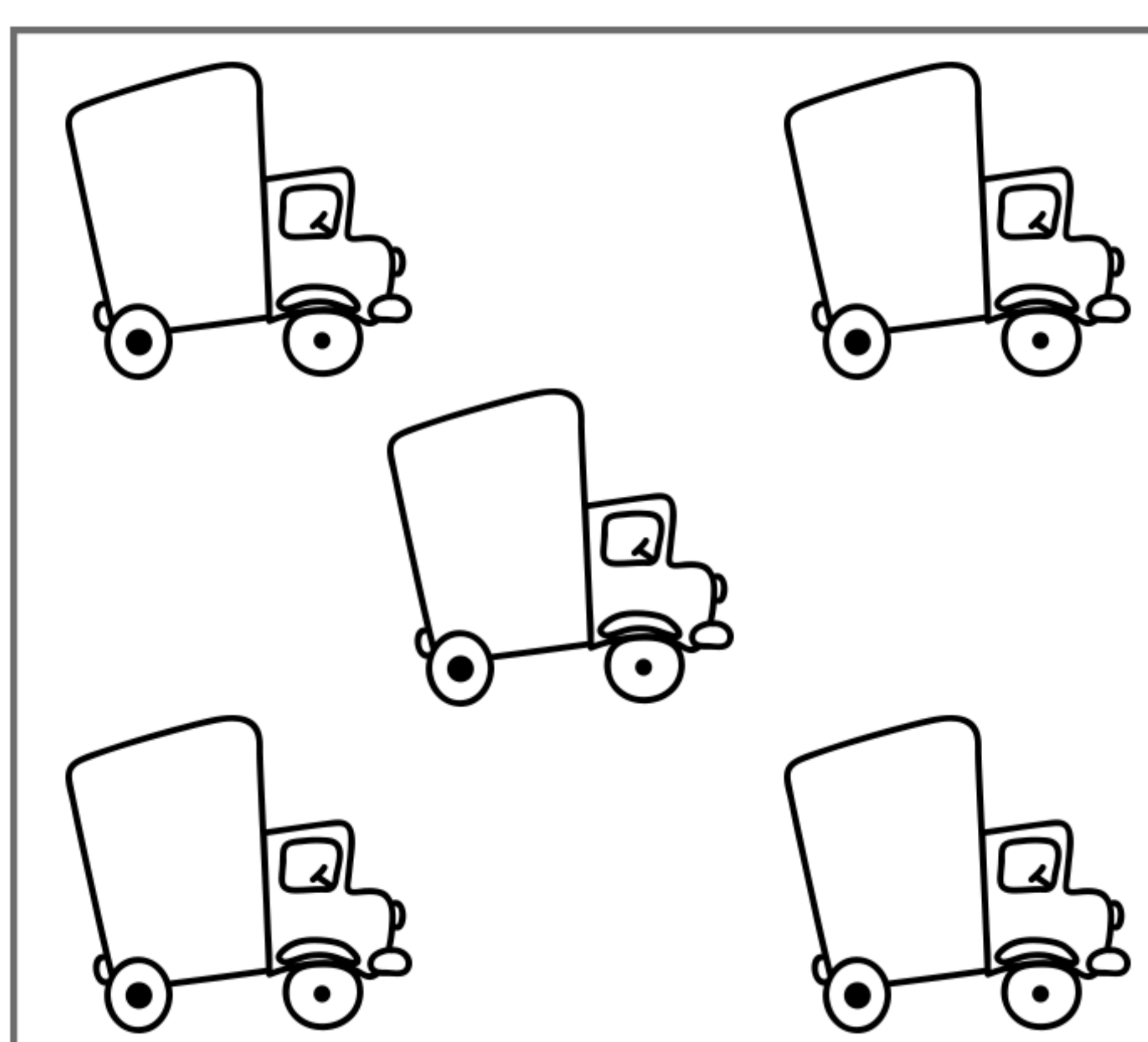

=



Sottrazioni con i disegni

- Conta, sottrai e scrivi il risultato nel riquadro di destra.

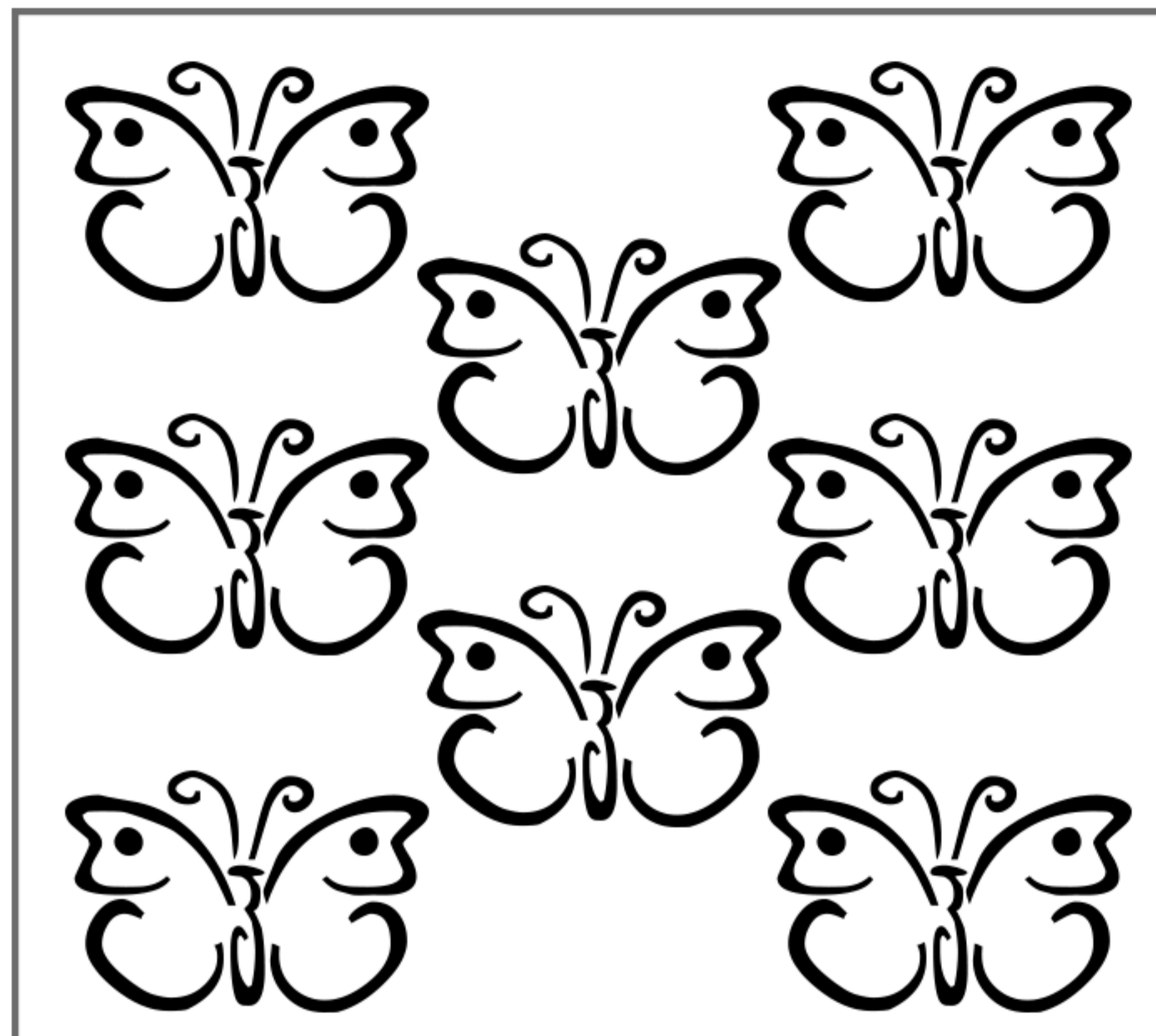

-

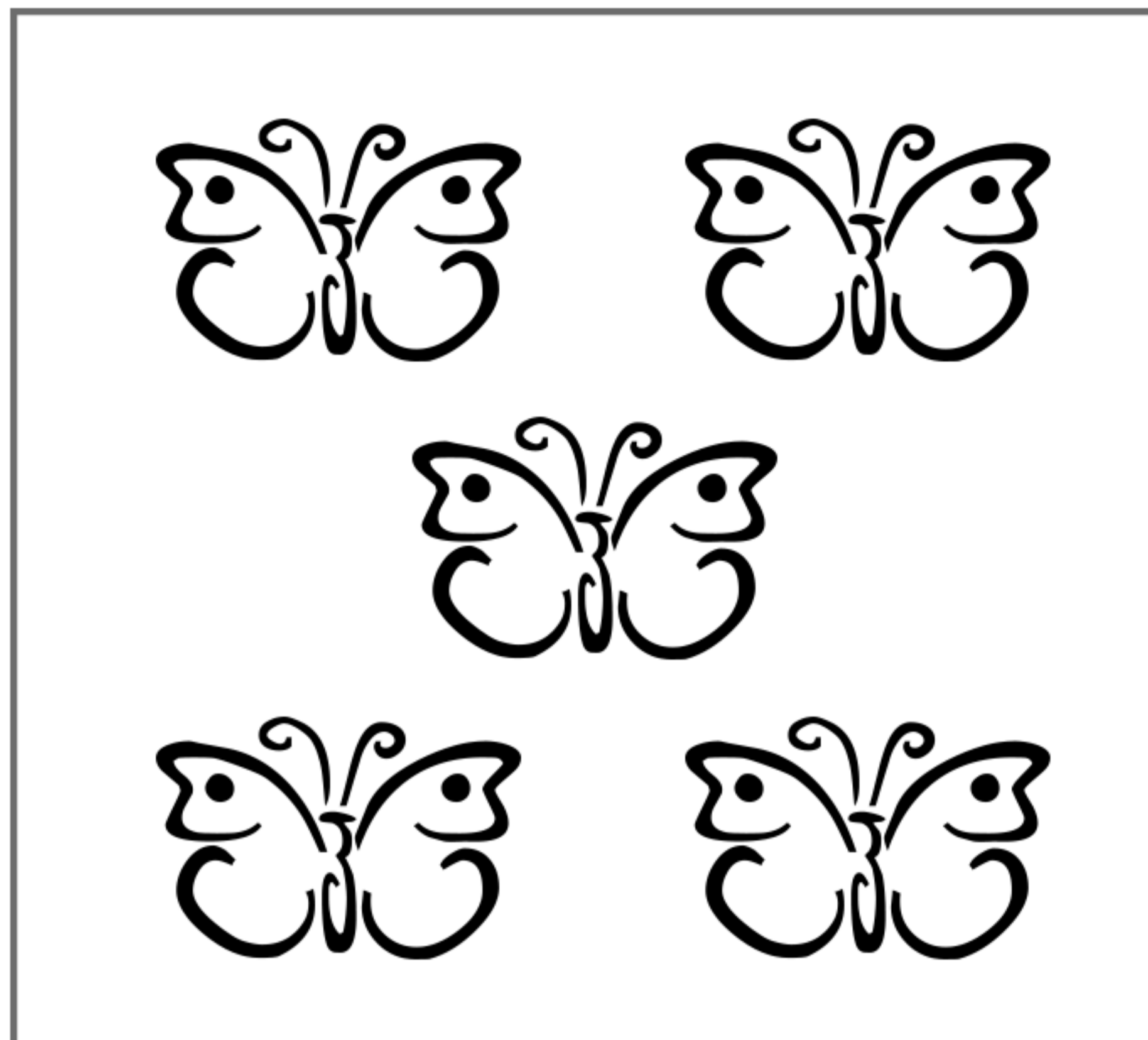

=

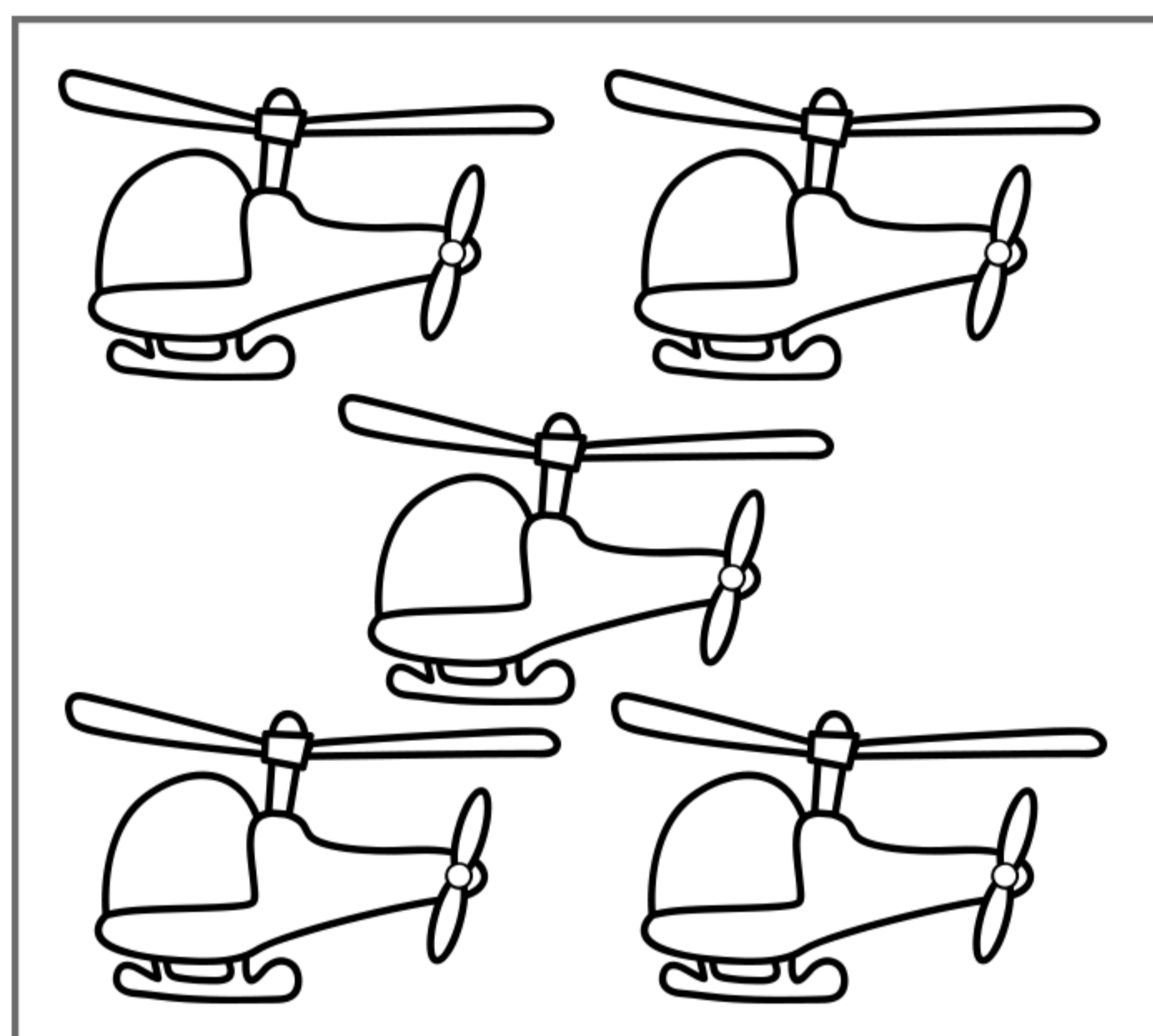
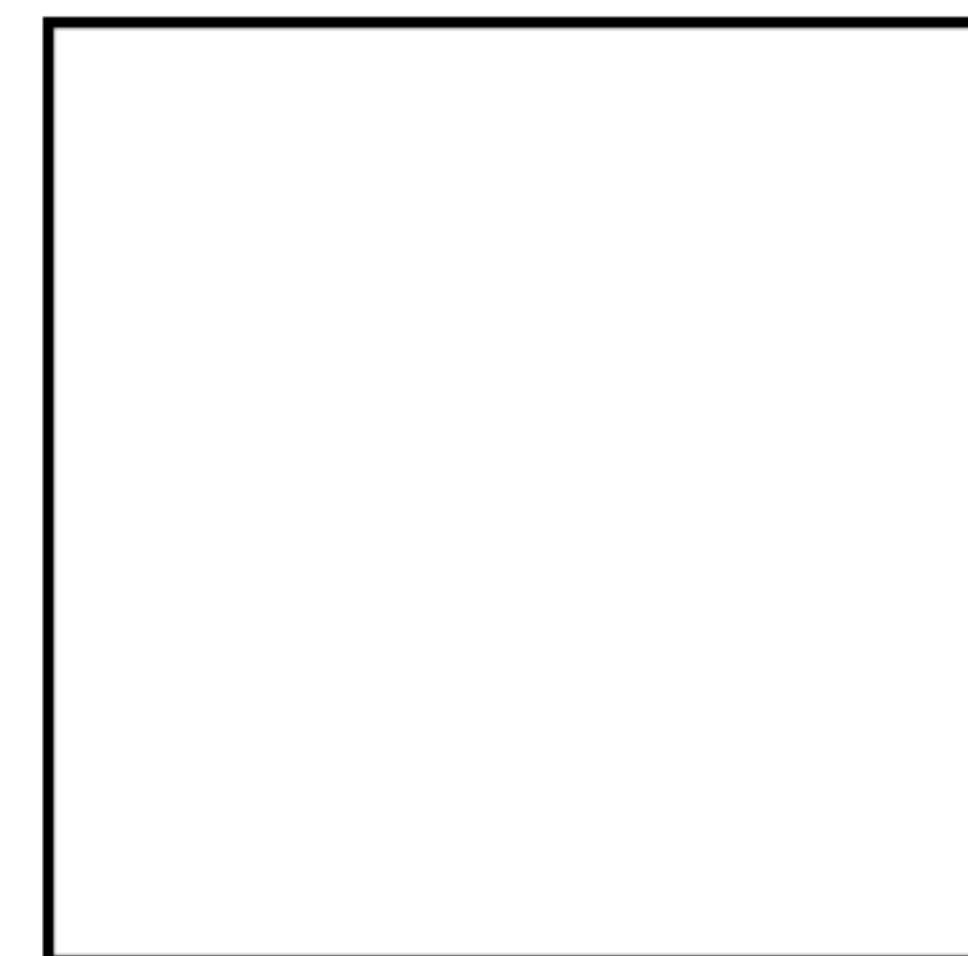

-

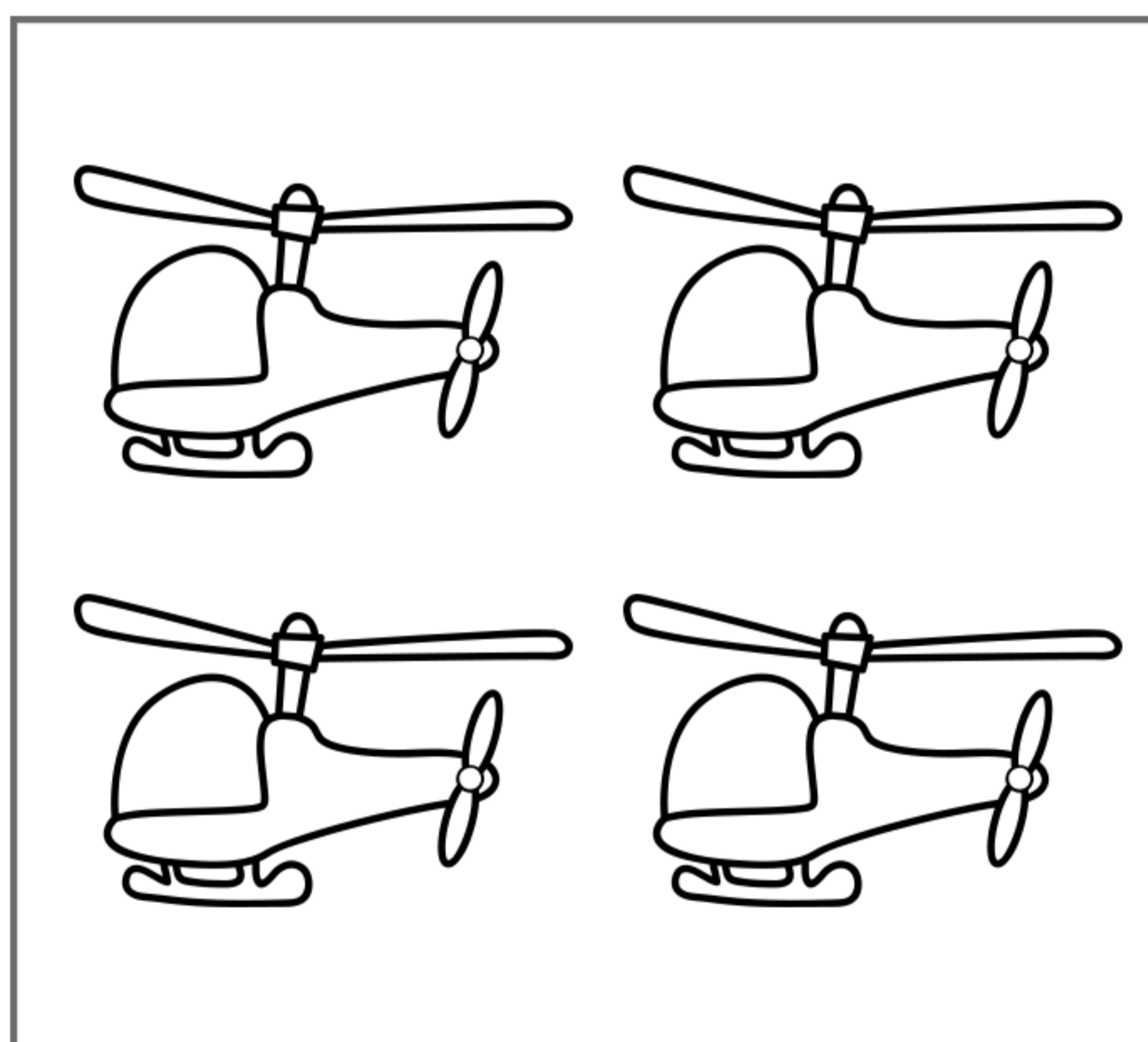

=

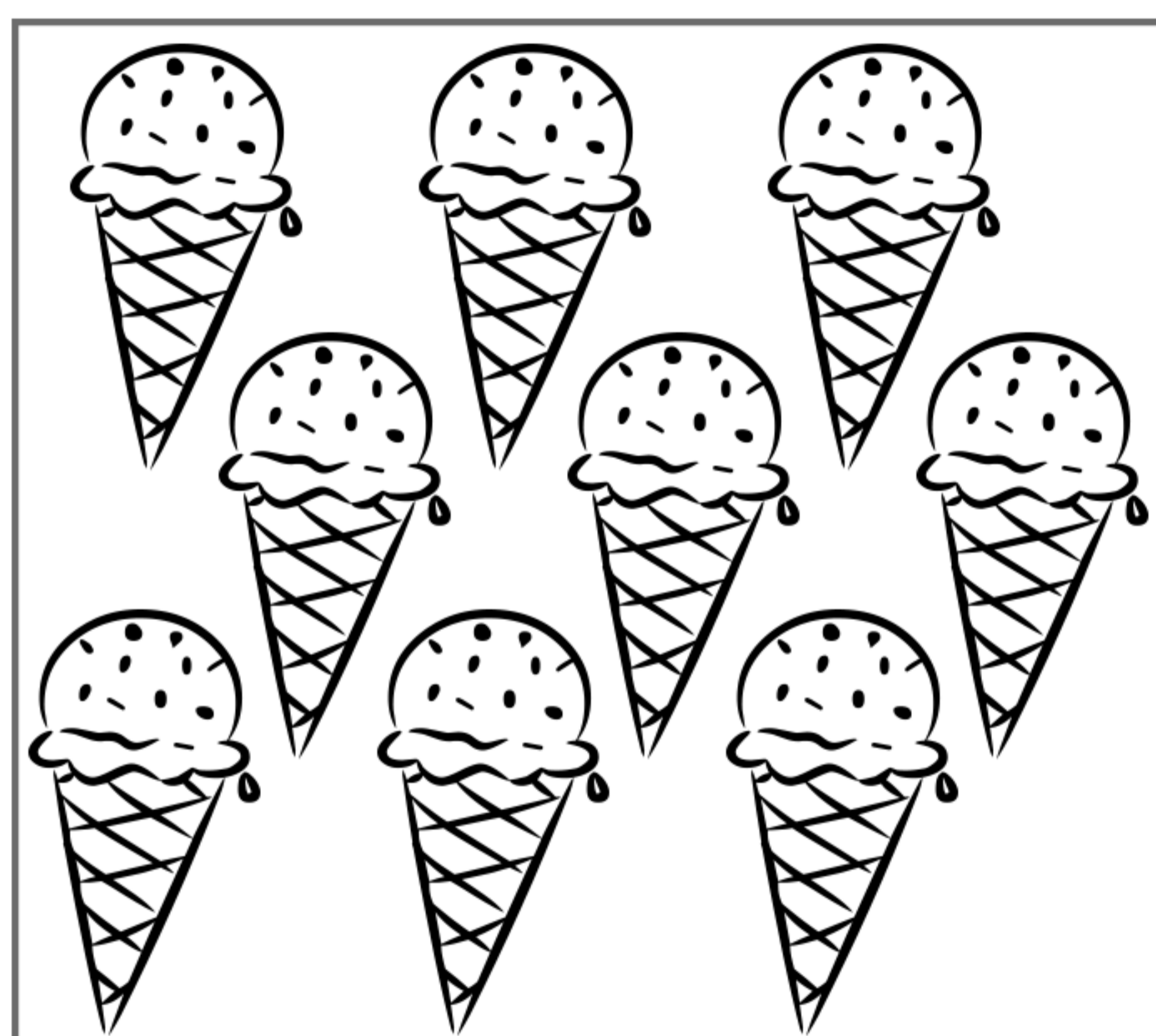
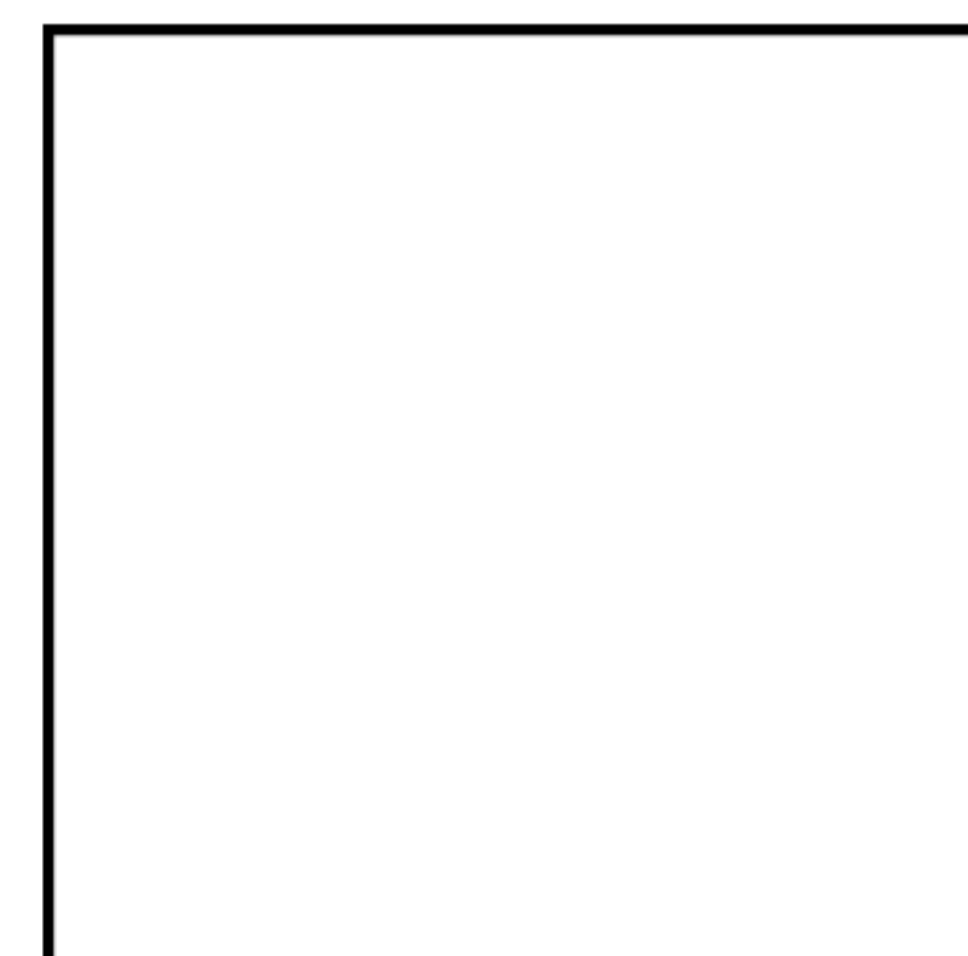

-

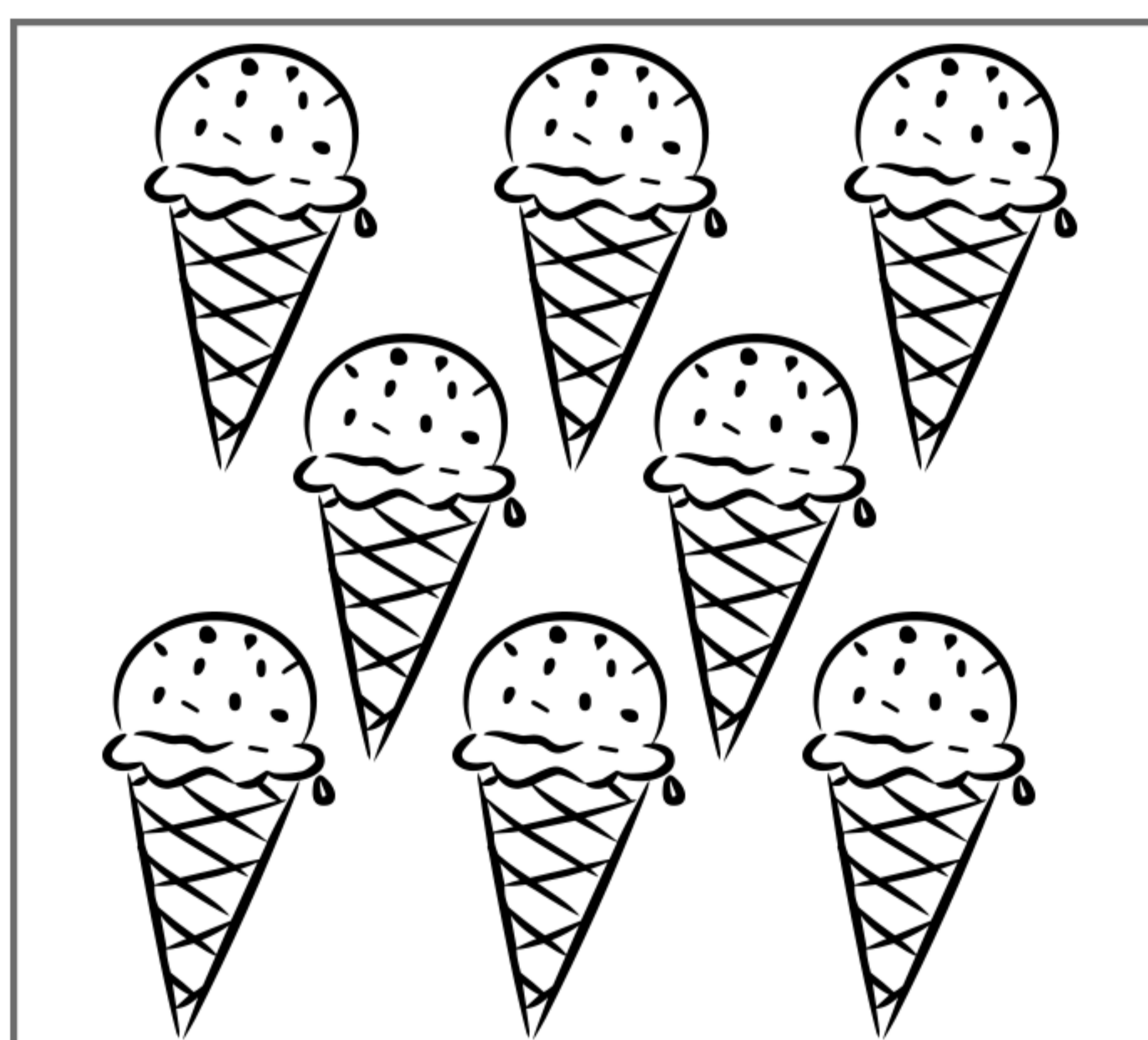

=

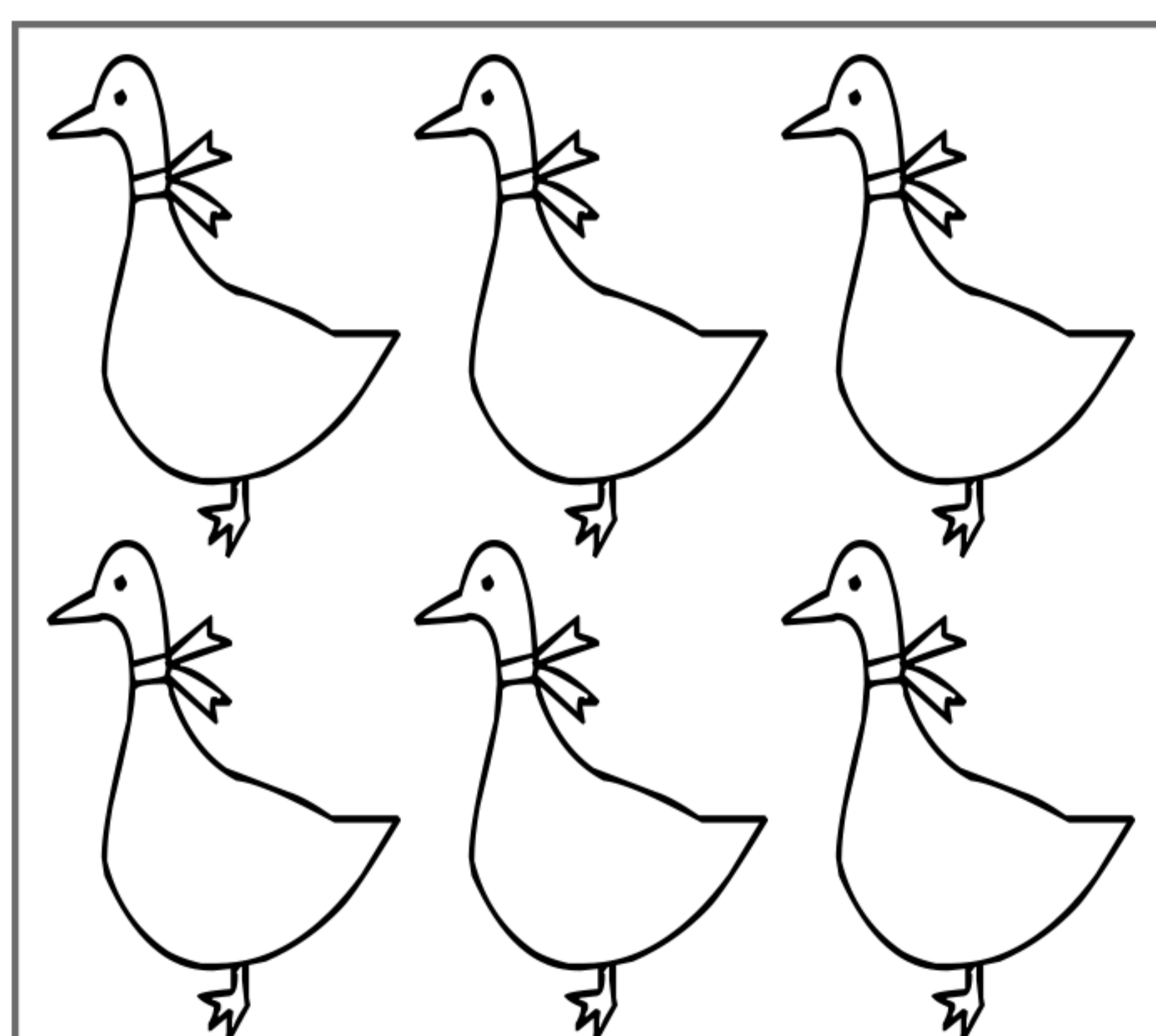
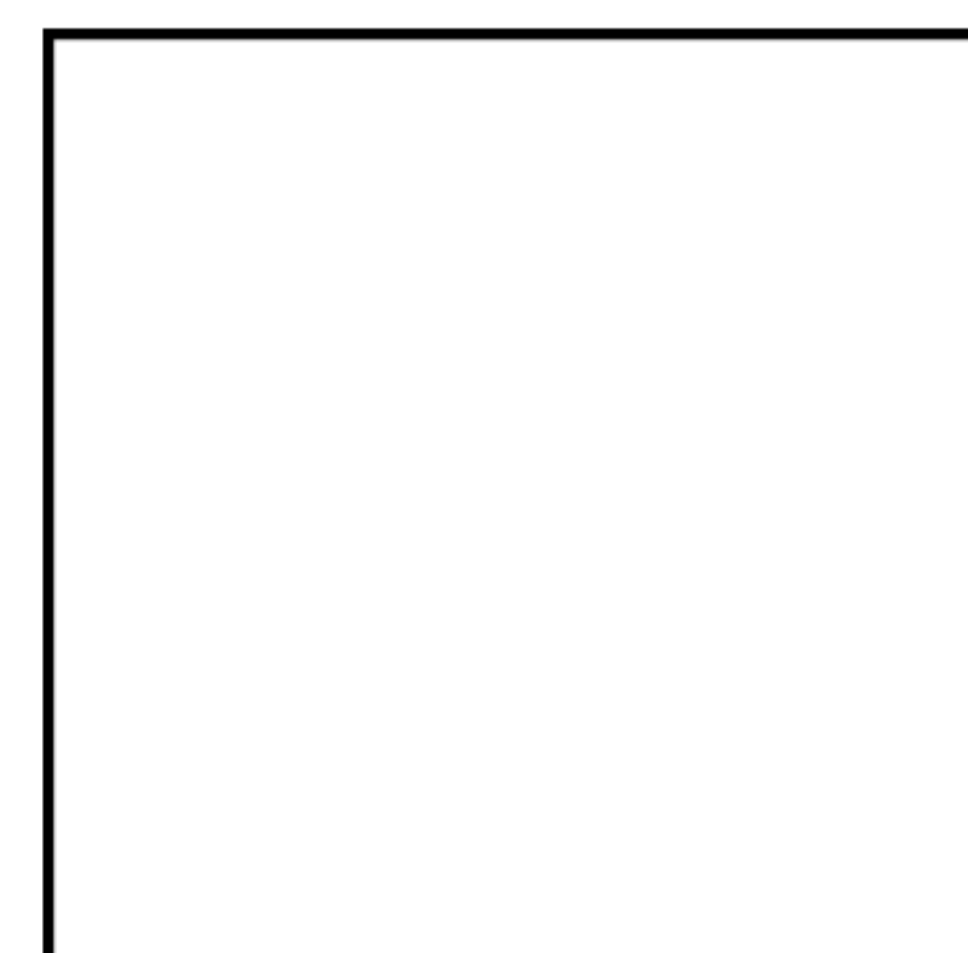

-

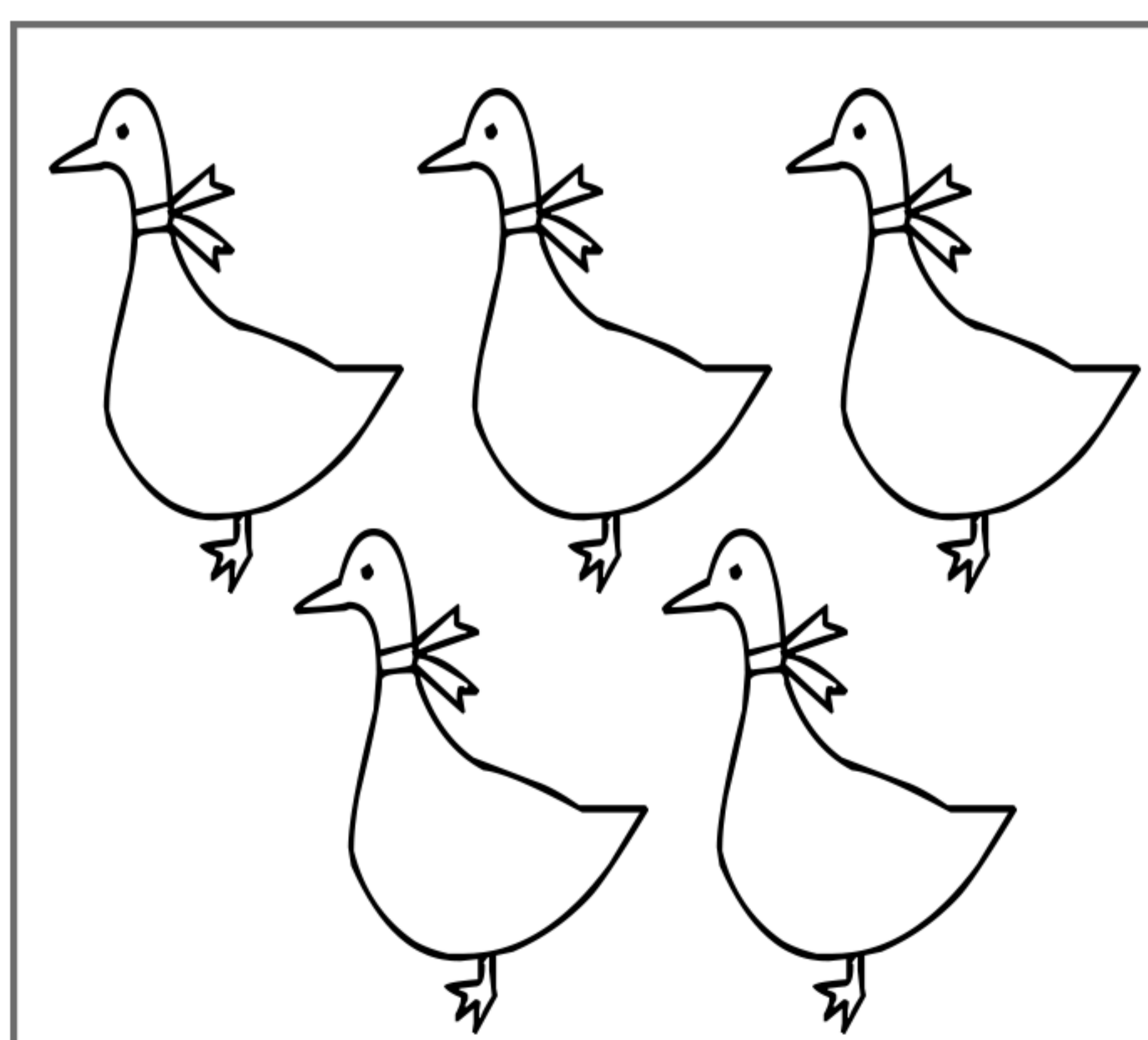

=

