

BILANCIA ANALITICA

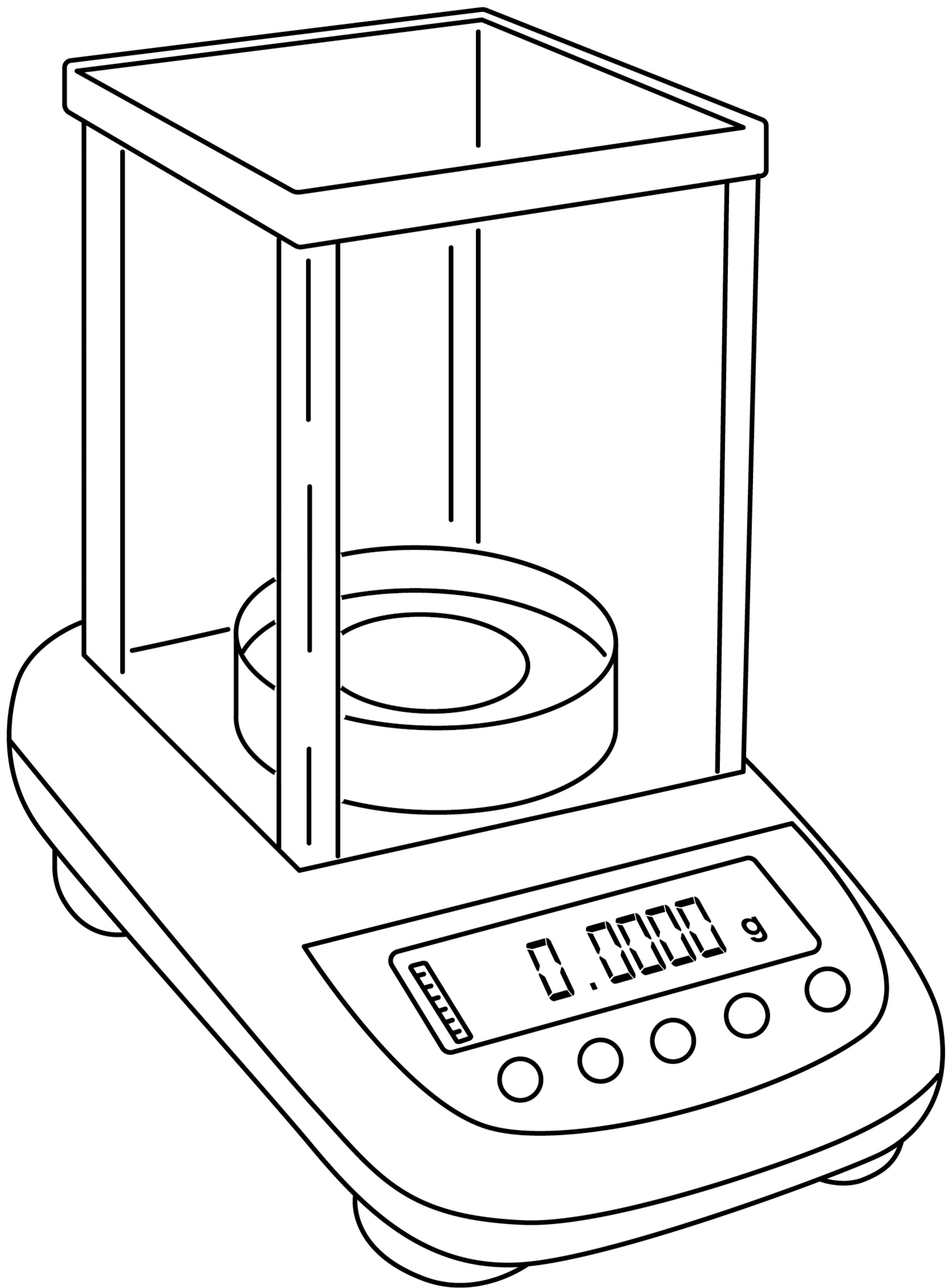

BINOCOLO

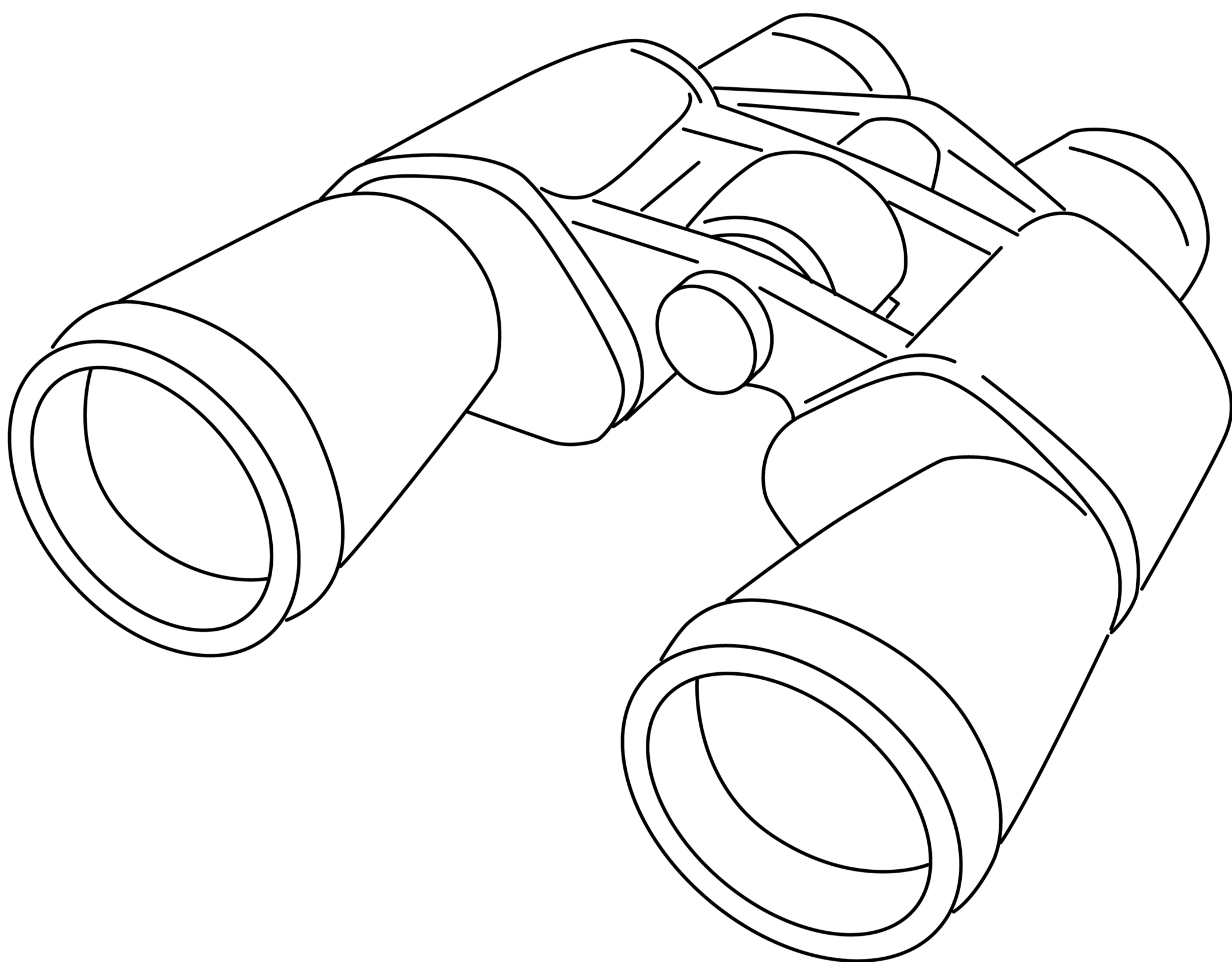

COMPUTER

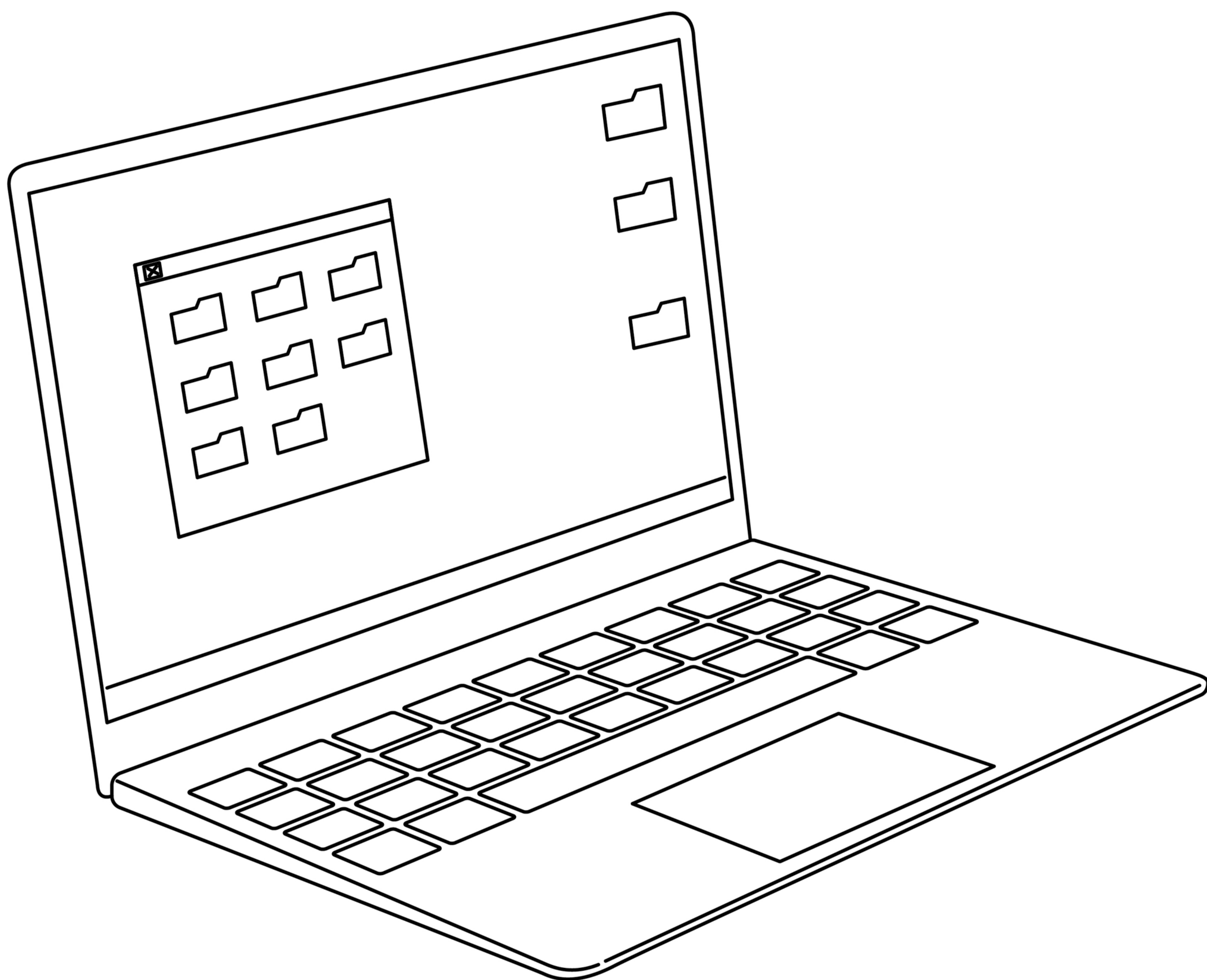

CRONOMETRO

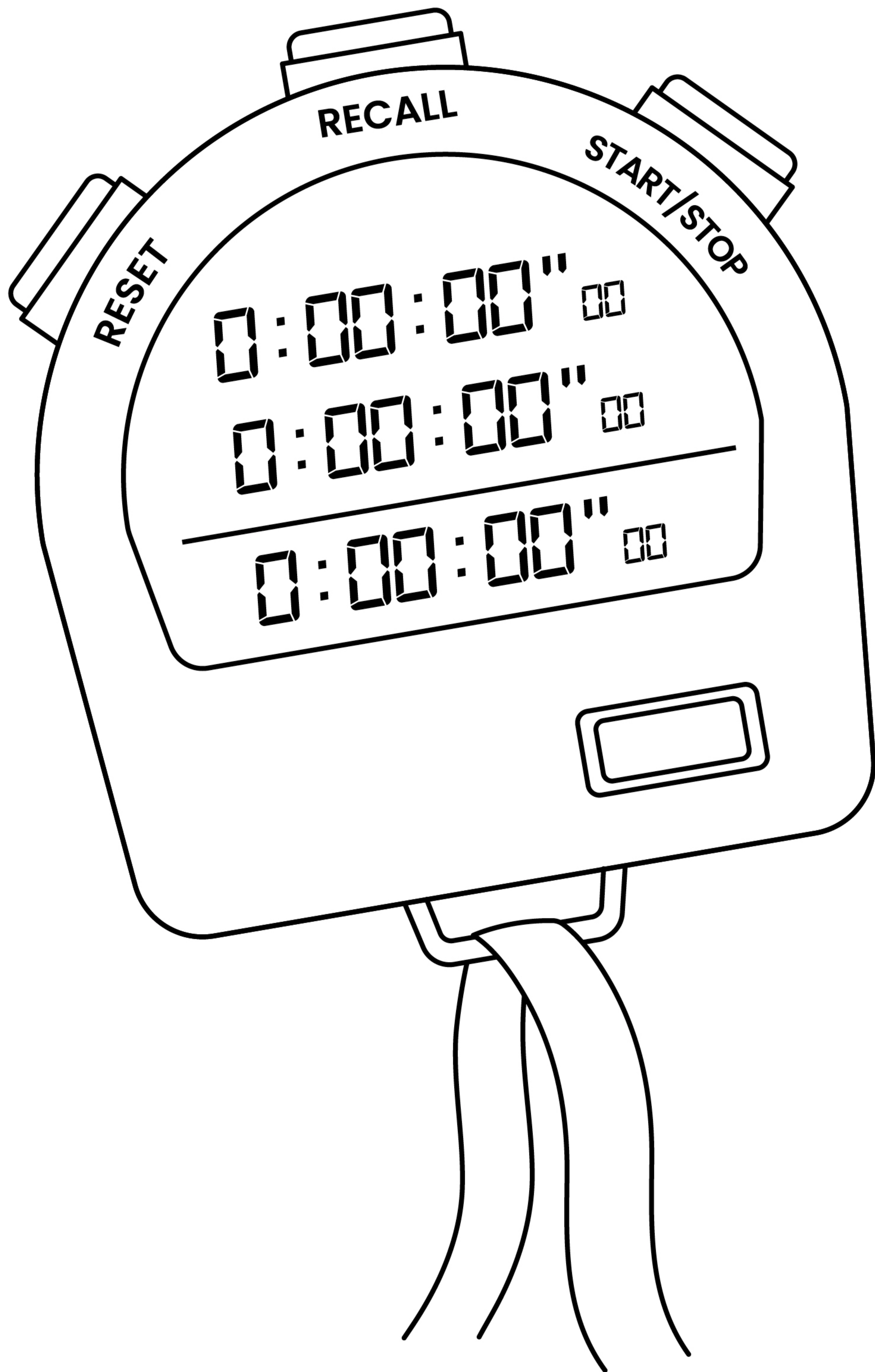

GUANTI E OCCHIALI PROTETTIVI

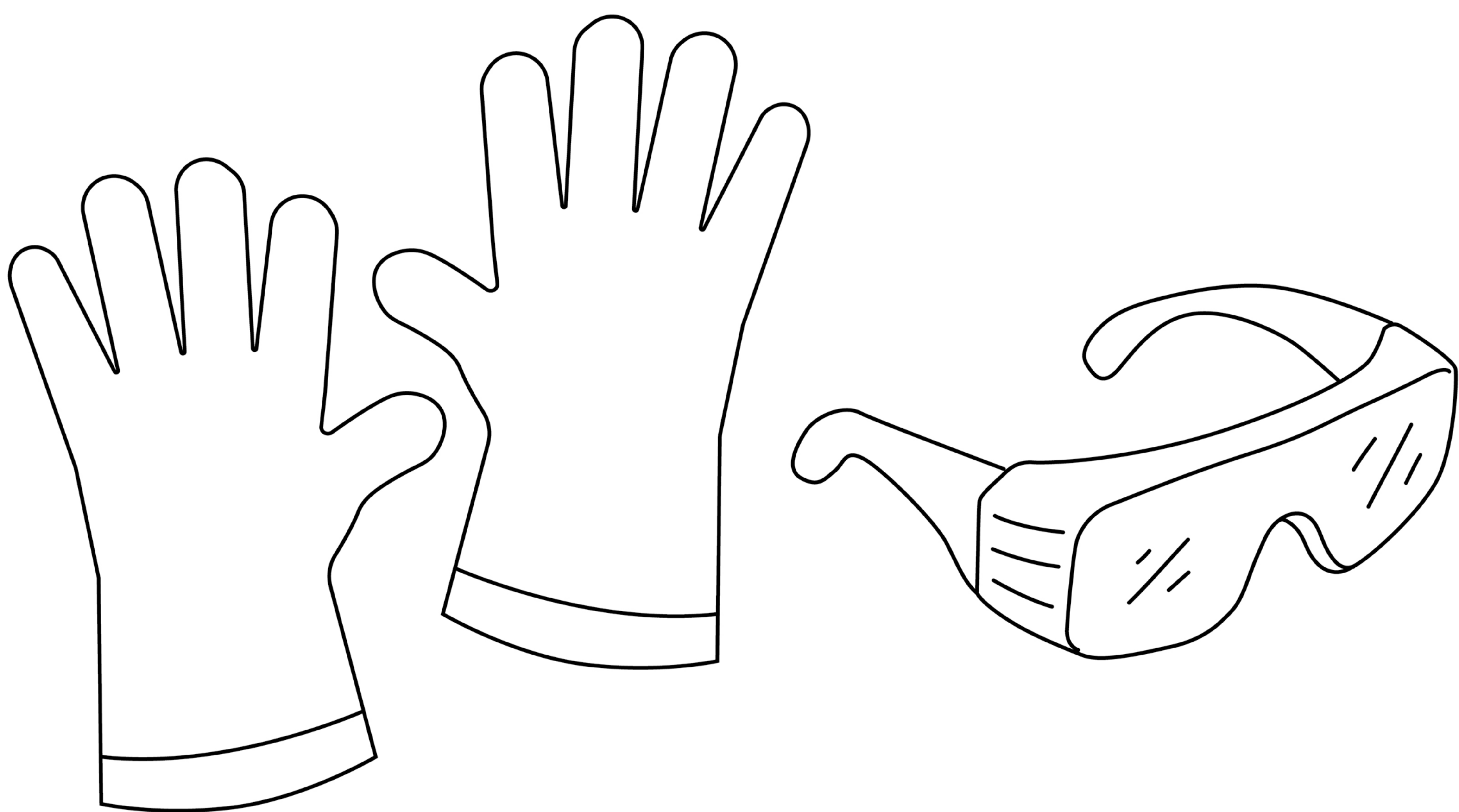

MICROSCOPIO

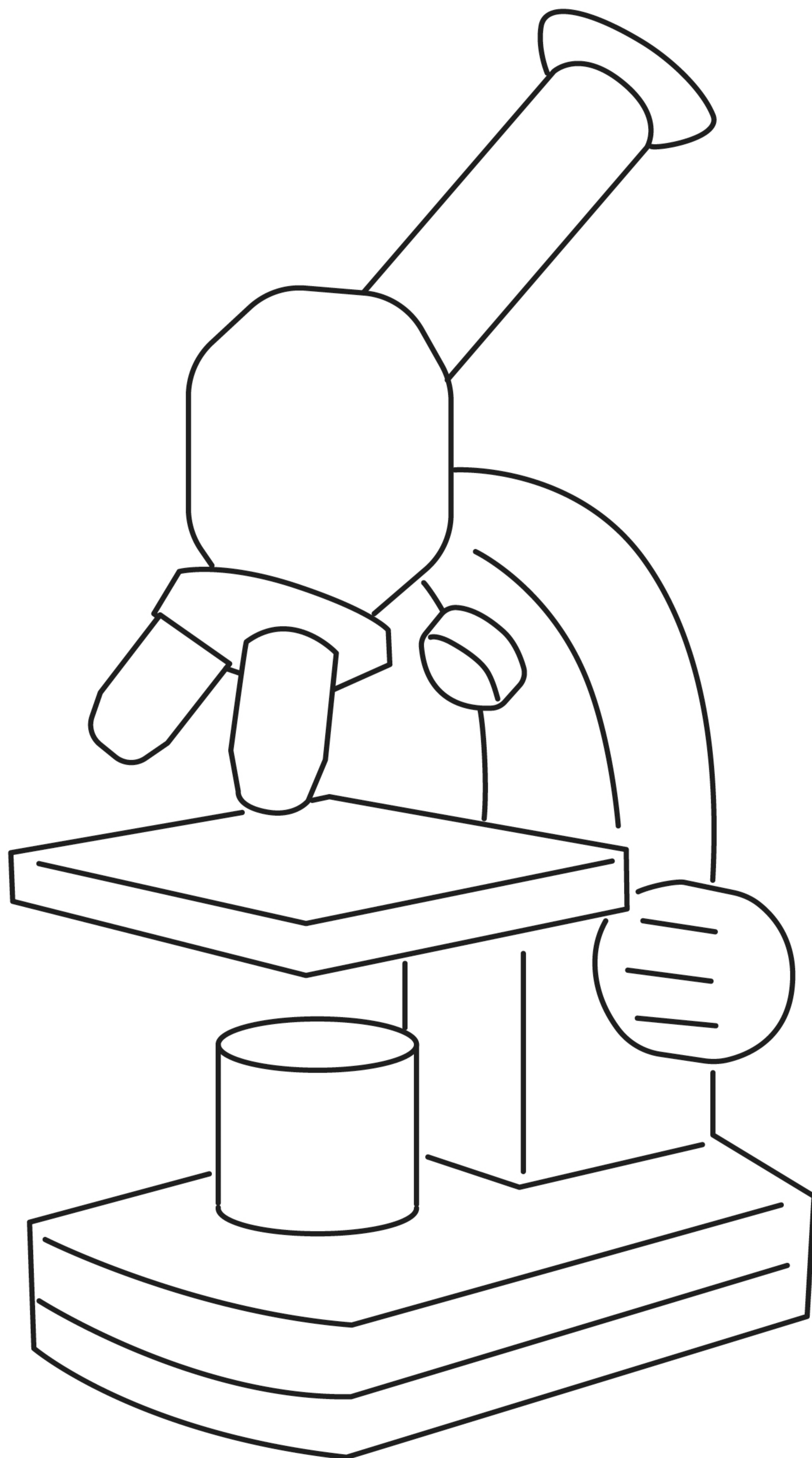

PROVETTE E CONTENITORI GRADUATI

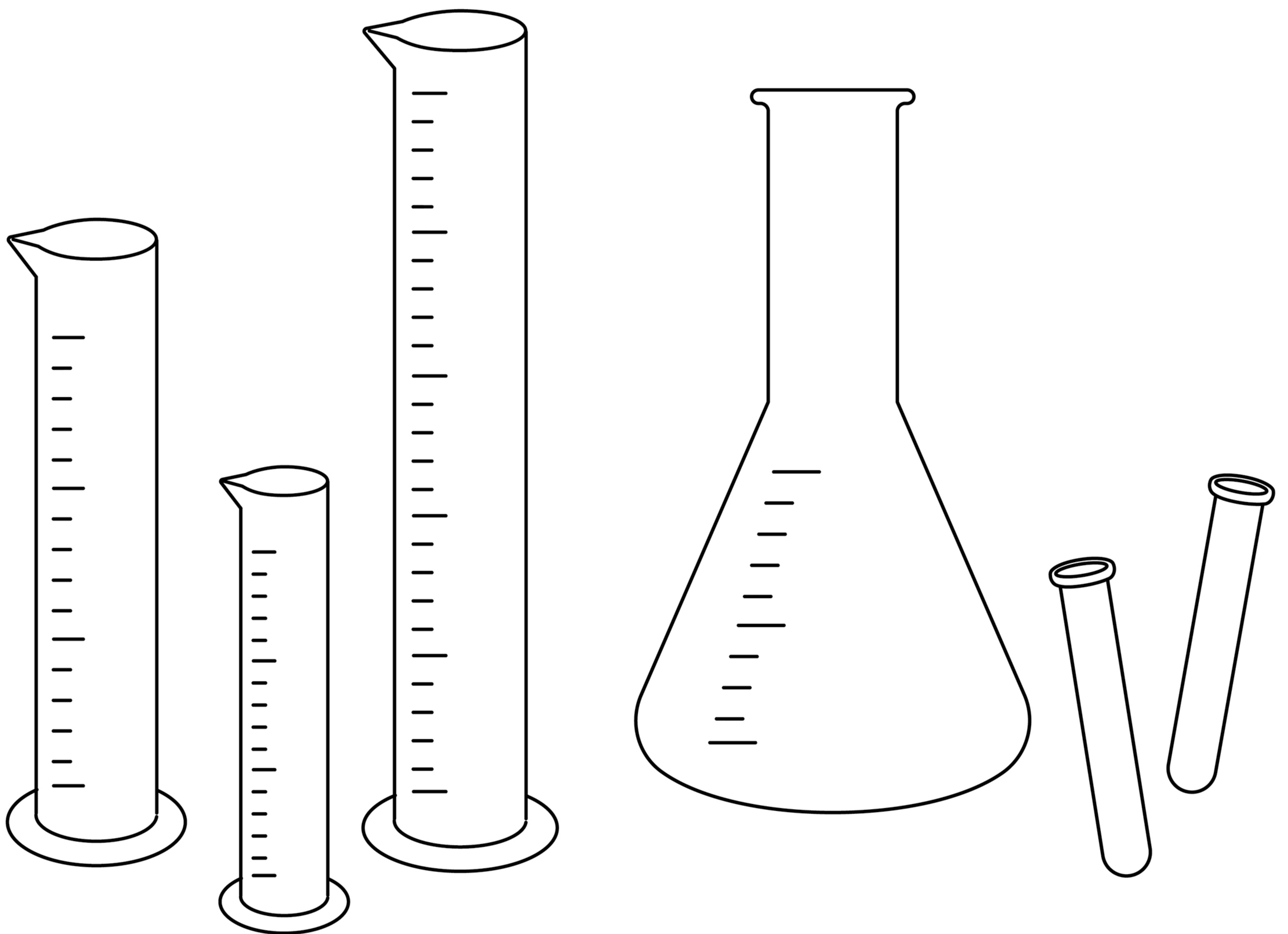

TELESCOPIO

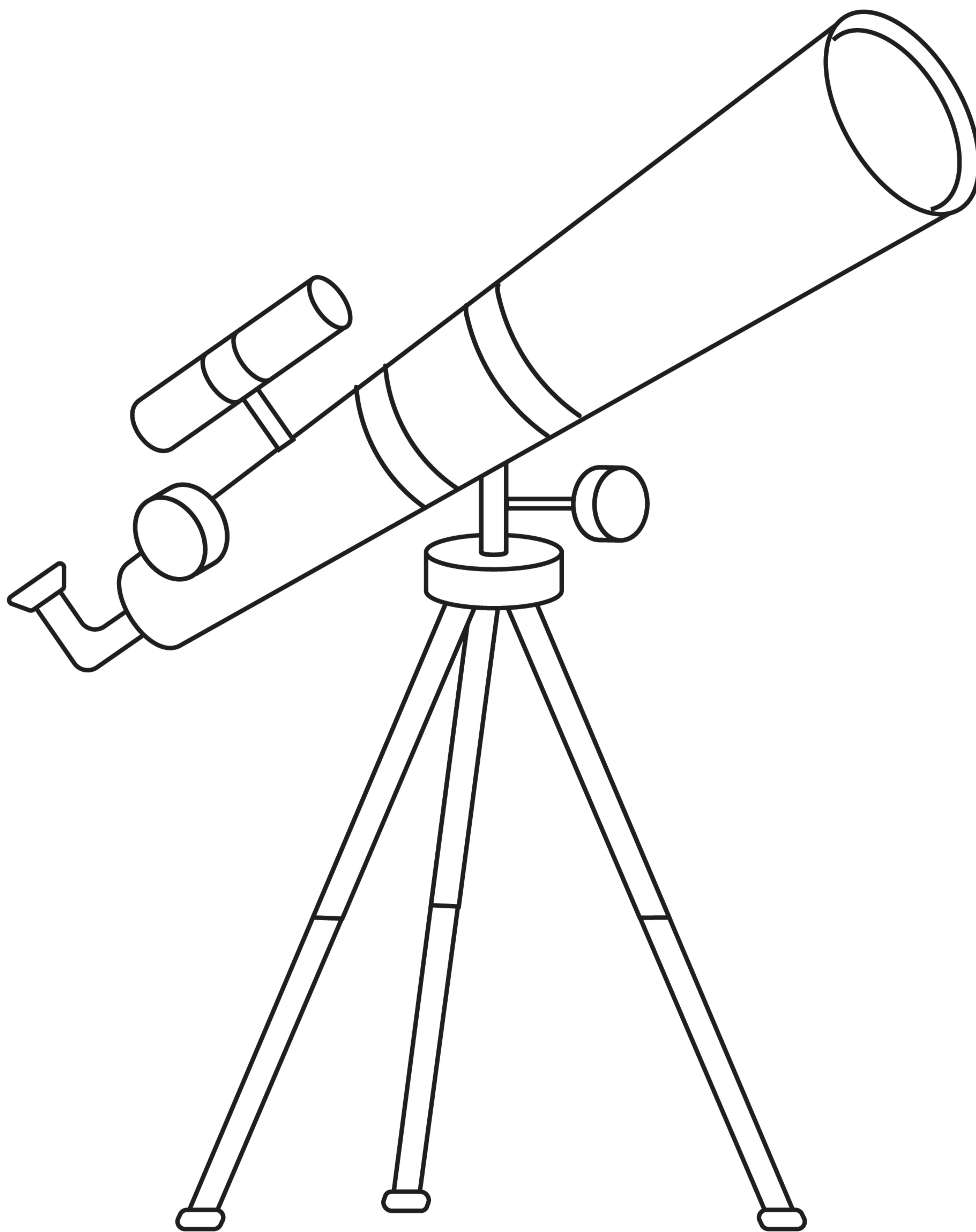

TERMOMETRO

