

Italiano 1^a

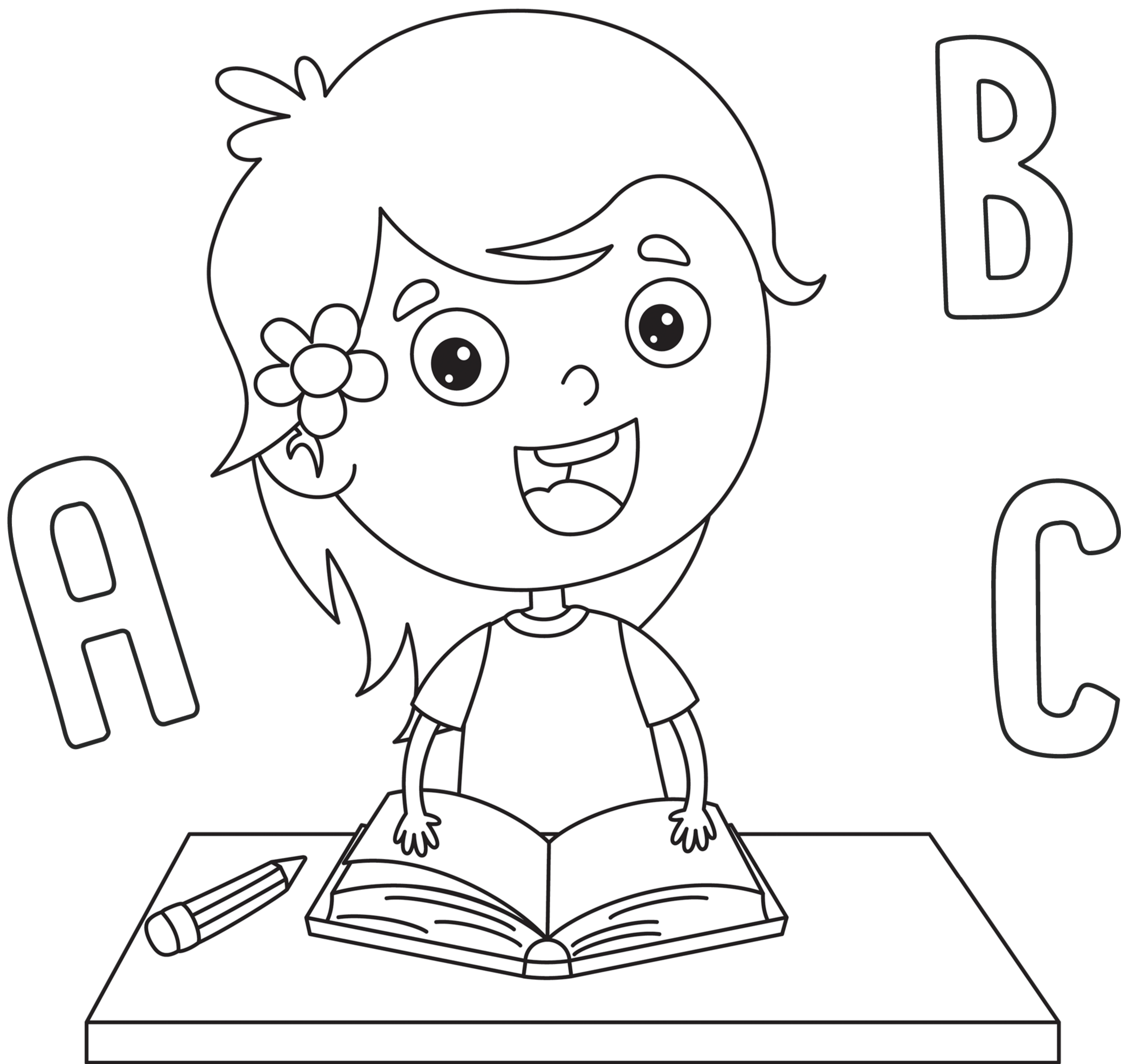

Schede didattiche di
italiano per la classe prima

Indice

A B C

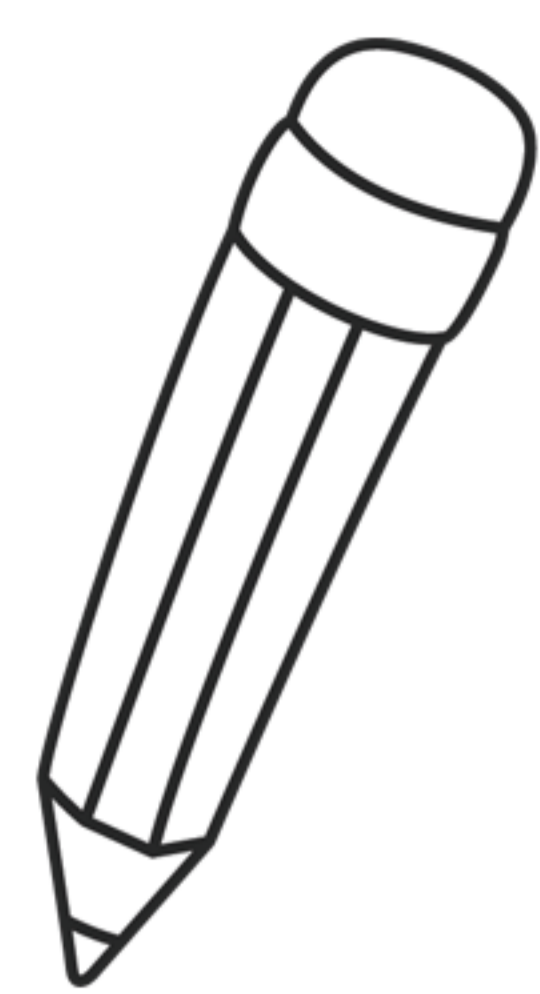

Ortografia

Suoni simili F - V	2-3
Suoni simili B - P	4-5
Suoni simili D - T	6-7
Suoni simili L - R	8-9
Suoni simili M - N	10-11
Suoni simili S - Z	12-13
CA - CO - CU	14
GA - GO - GU	15
CIA - CIO - CIU	16
GIA - GIO - GIU	17
CE - CI	18
GE - GI	19
CHE - CHI	20
GHE - GHI	21
SCA - SCO - SCU	22
SCHE - SCHI	23
SCE - SCI	24
SCIA - SCIO - SCIU	25
GLI	26
GN	27
CU - QU	28
CU - QU - CQU	29
MB - MP	30-31
Suoni difficili	32-34

Lettere ponte L M N R	35-37
Lettere straniere J K W X Y	38-41
Le doppie	42
Le sillabe	43
L'apostrofo	44-45
L'accento	46-47
"E" che unisce	48
"È" che spiega	49
C'È - CI SONO	50
C'ERA - C'ERANO	51
HO - HAI	52
HA - HANNO	53
La punteggiatura	54

Morfologia

I nomi	55
I nomi comuni e propri	56
Gli articoli determinativi	57
Gli articoli indeterminativi	58
Nomi maschili e femminili	59-60
Nomi singolari e plurali	61-62

Sintassi

Le azioni	63-64
Le qualità	65-66
La frase	67-68

Suoni simili: F-V

- Completa le parole con F o V.

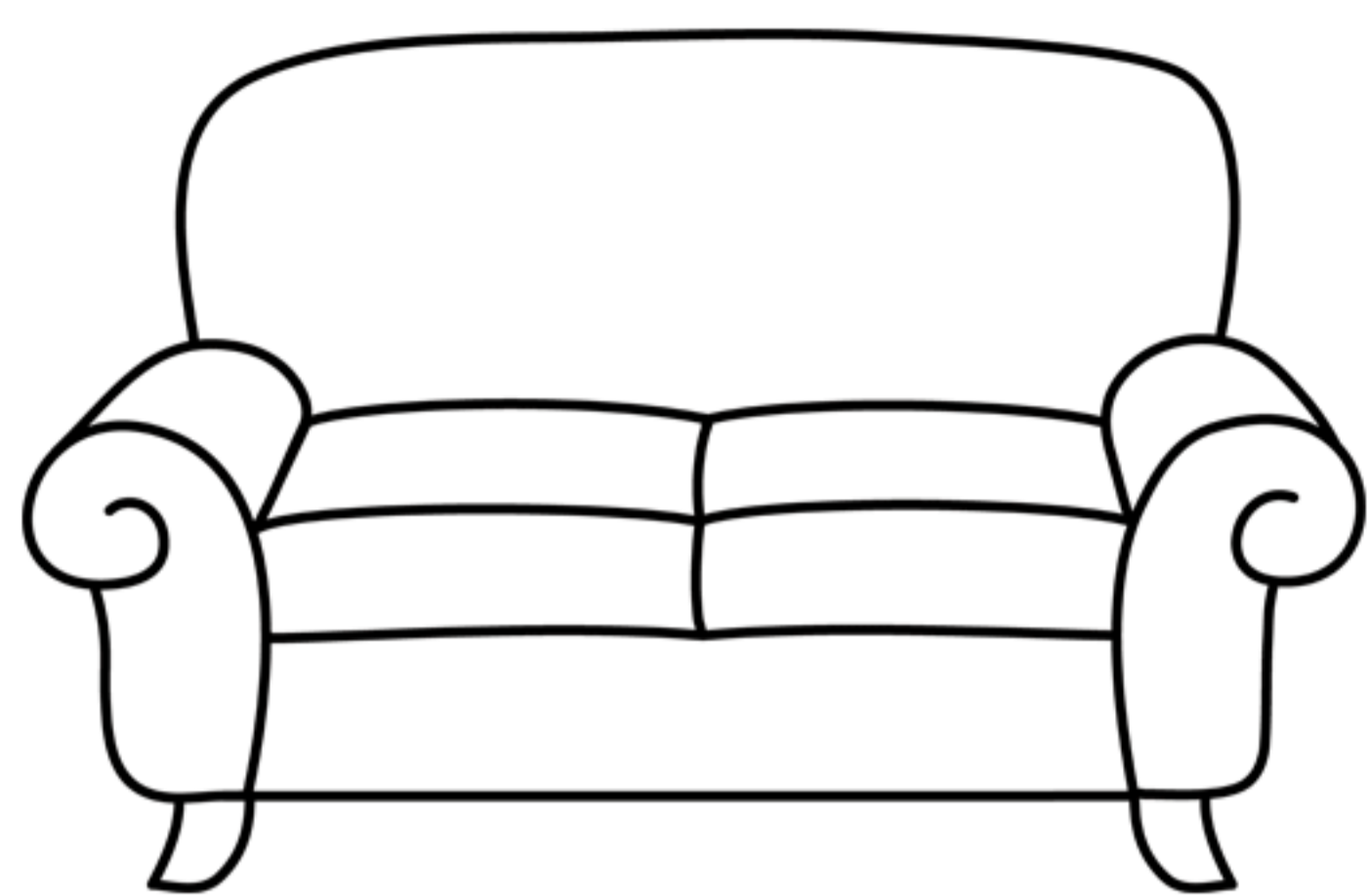

di ...

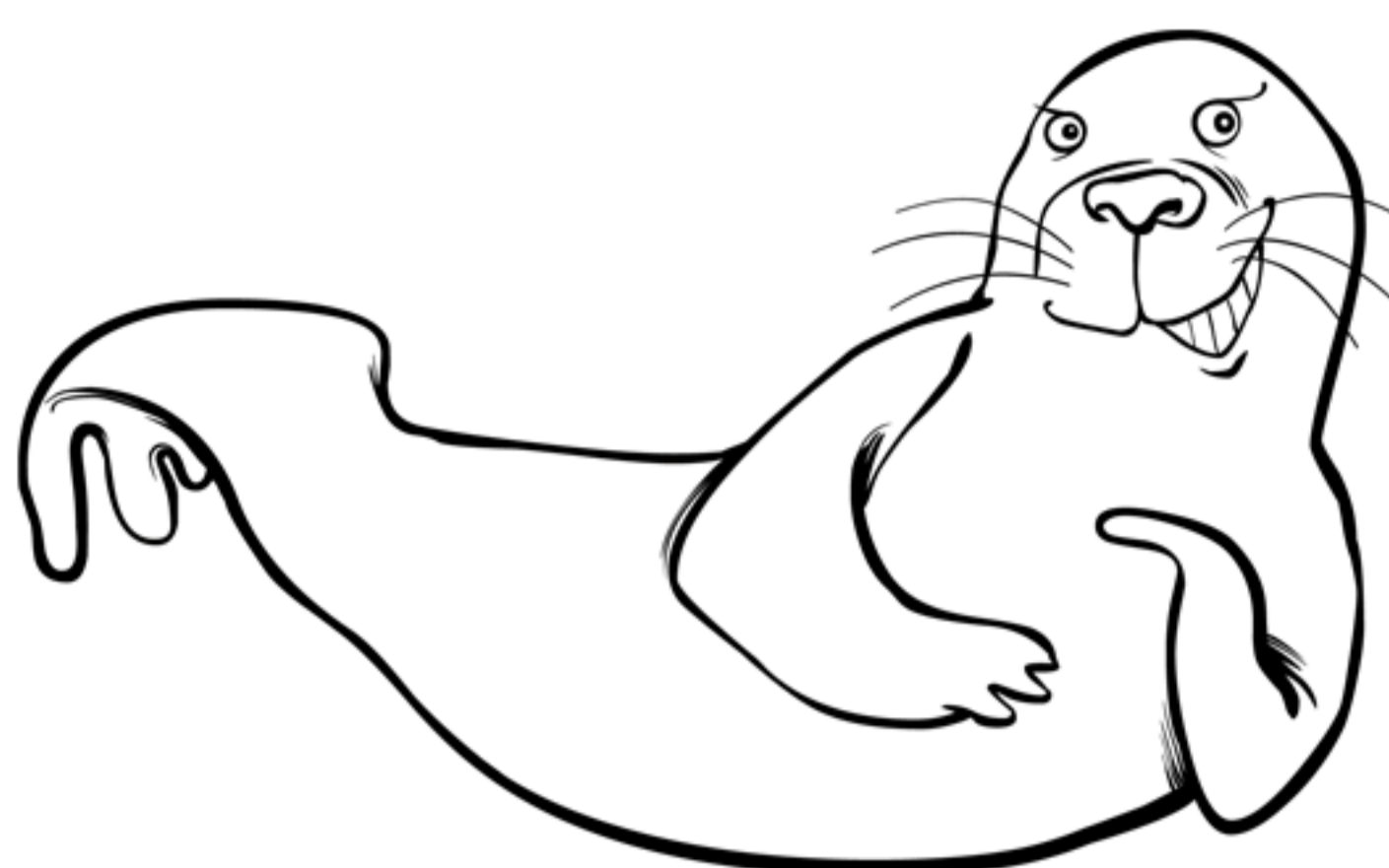

...a

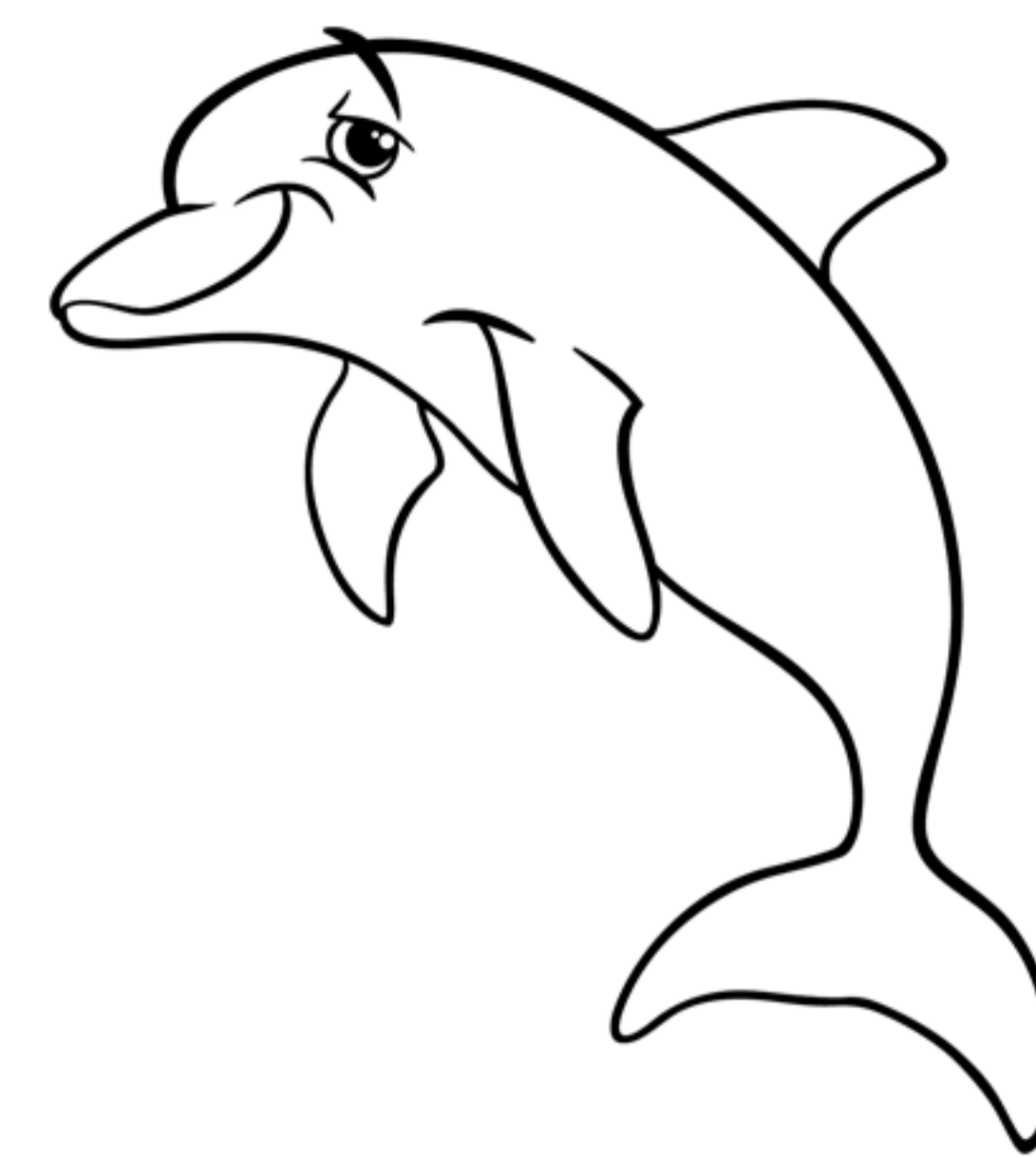

del ...

Questa è una copia
dimostrativa.

Tutti i nostri eBook possono
essere acquistati sul sito.

©Pianetabambini.it

... ipera

... antasma

... olpe



... iolino



ci ... etta

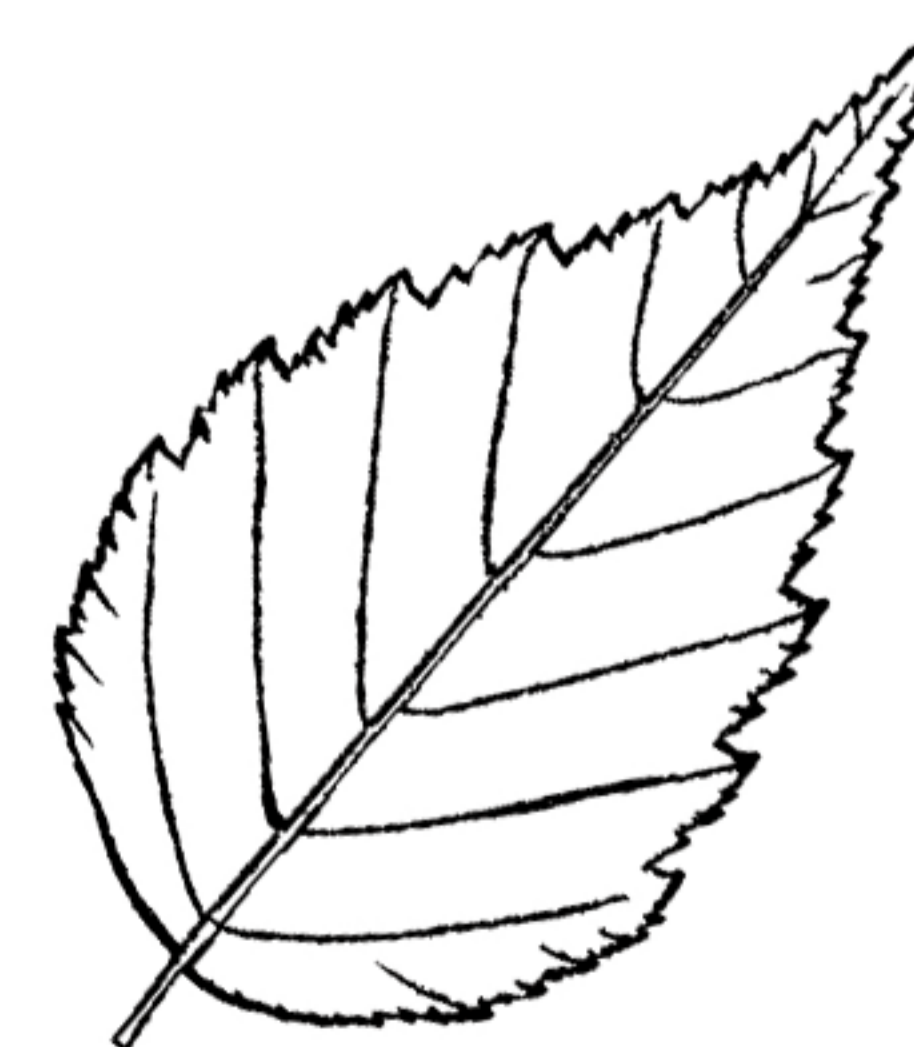

... oglia

Suoni simili: F-V

- Completa le frasi con le parole raffigurate.

- La  turchina ha le ali e una bacchetta magica.

- Il  ha una bellissima coda a ventaglio.

Questa è una copia
dimostrativa.

Tutti i nostri eBook possono
essere acquistati sul sito.

©Pianetabambini.it

- La  di mia sorella era pesantissima.

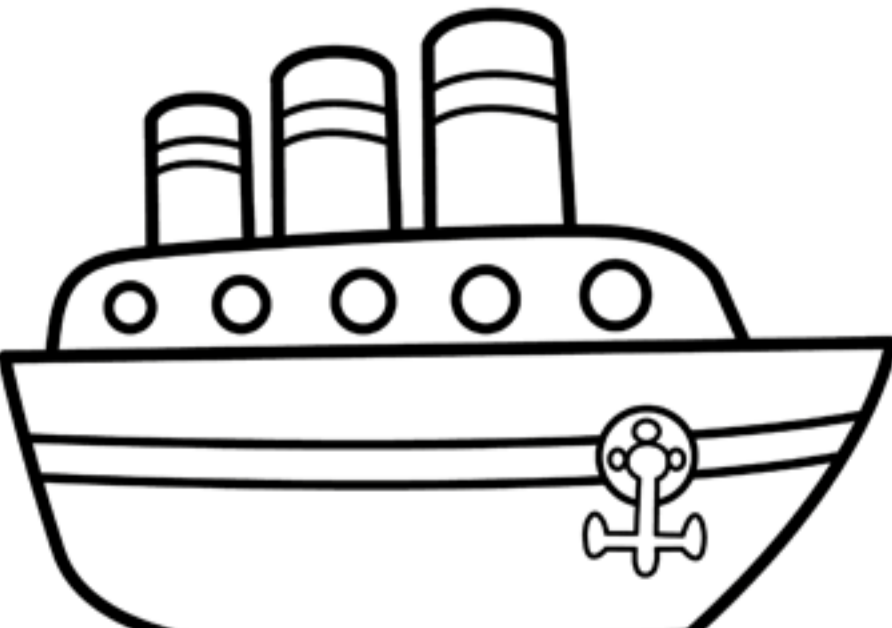
- I miei zii hanno preso la  per andare in Sardegna.

Suoni simili: B-P

- Completa le parole con B o P.

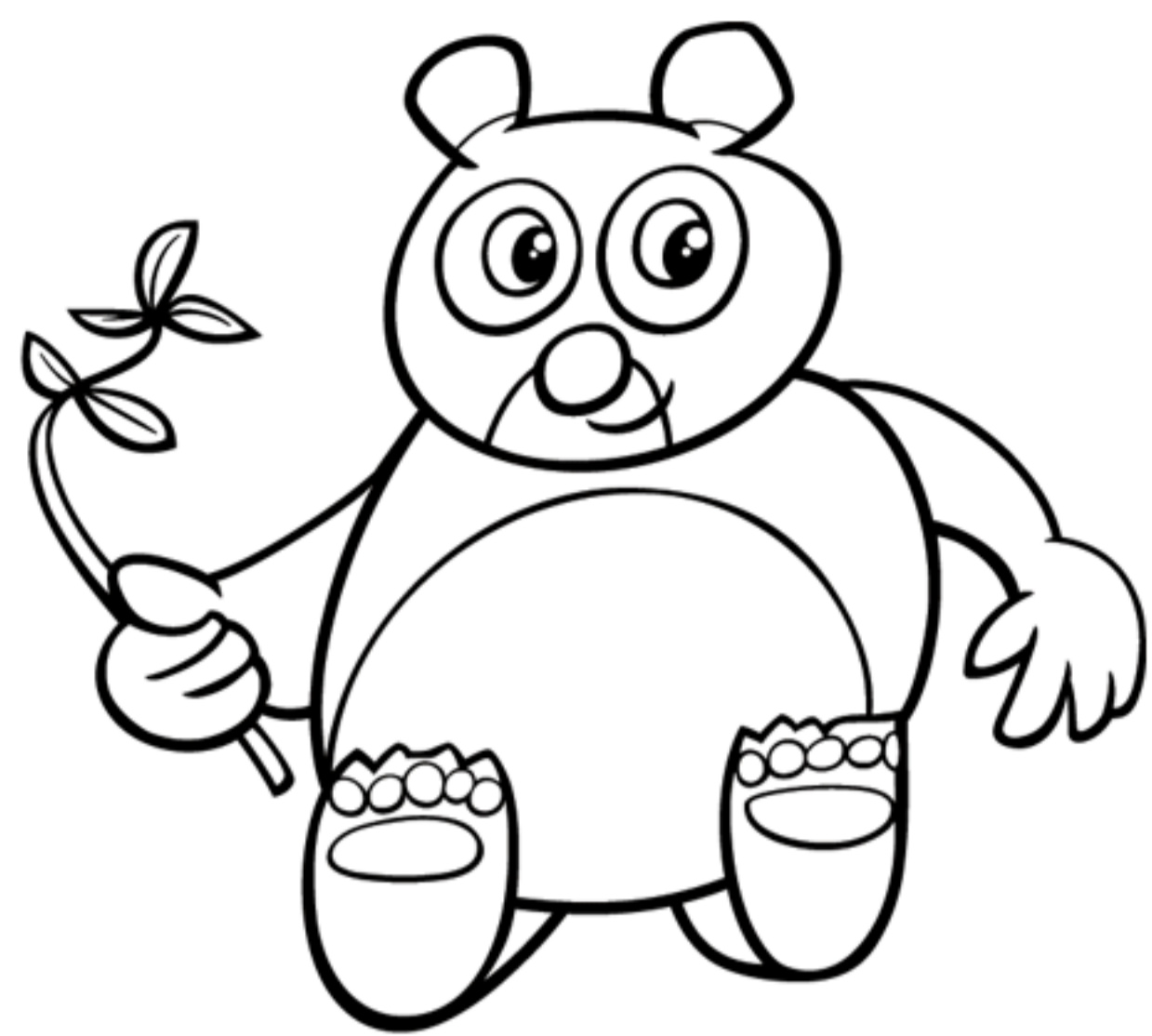

anda

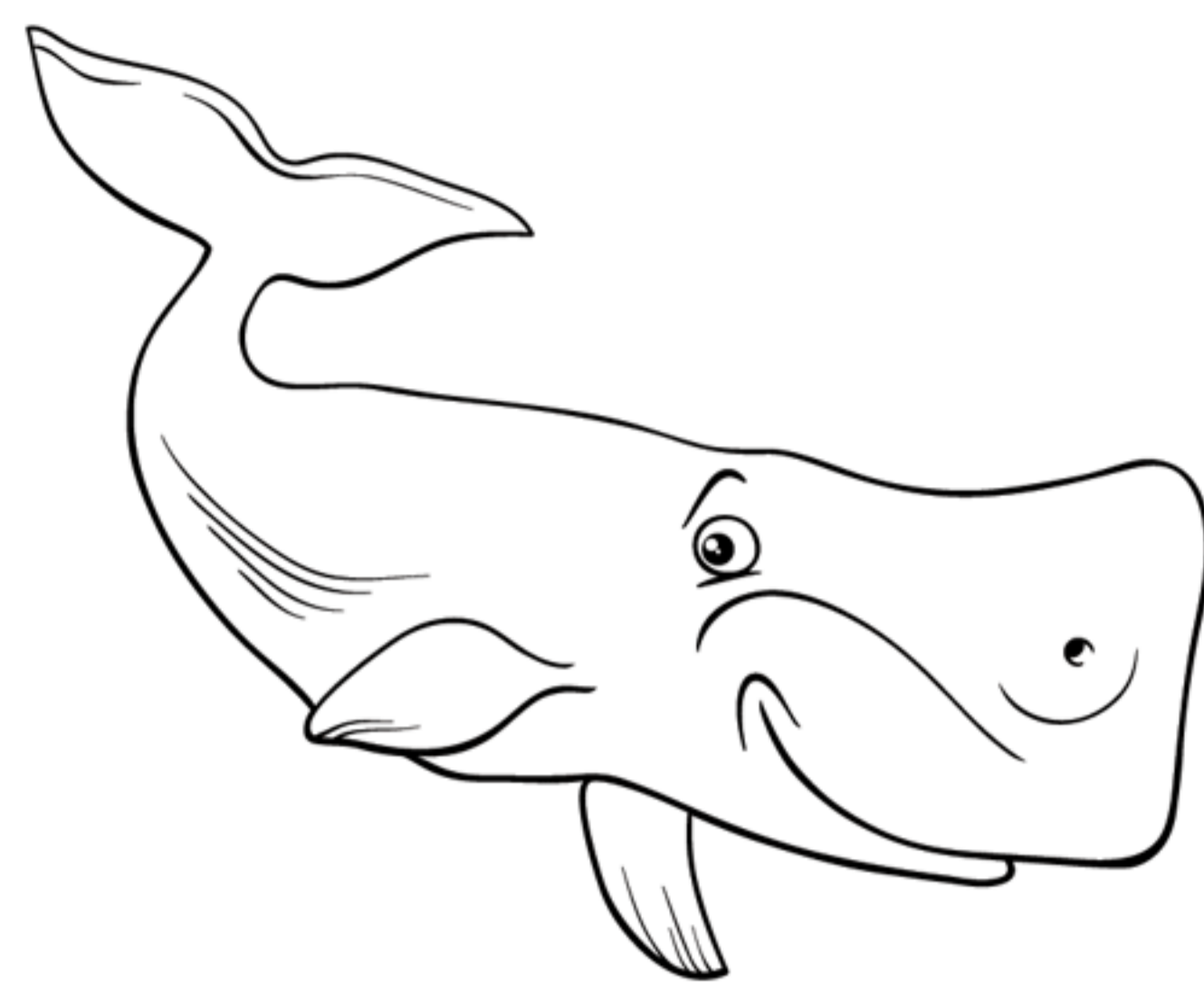

alona

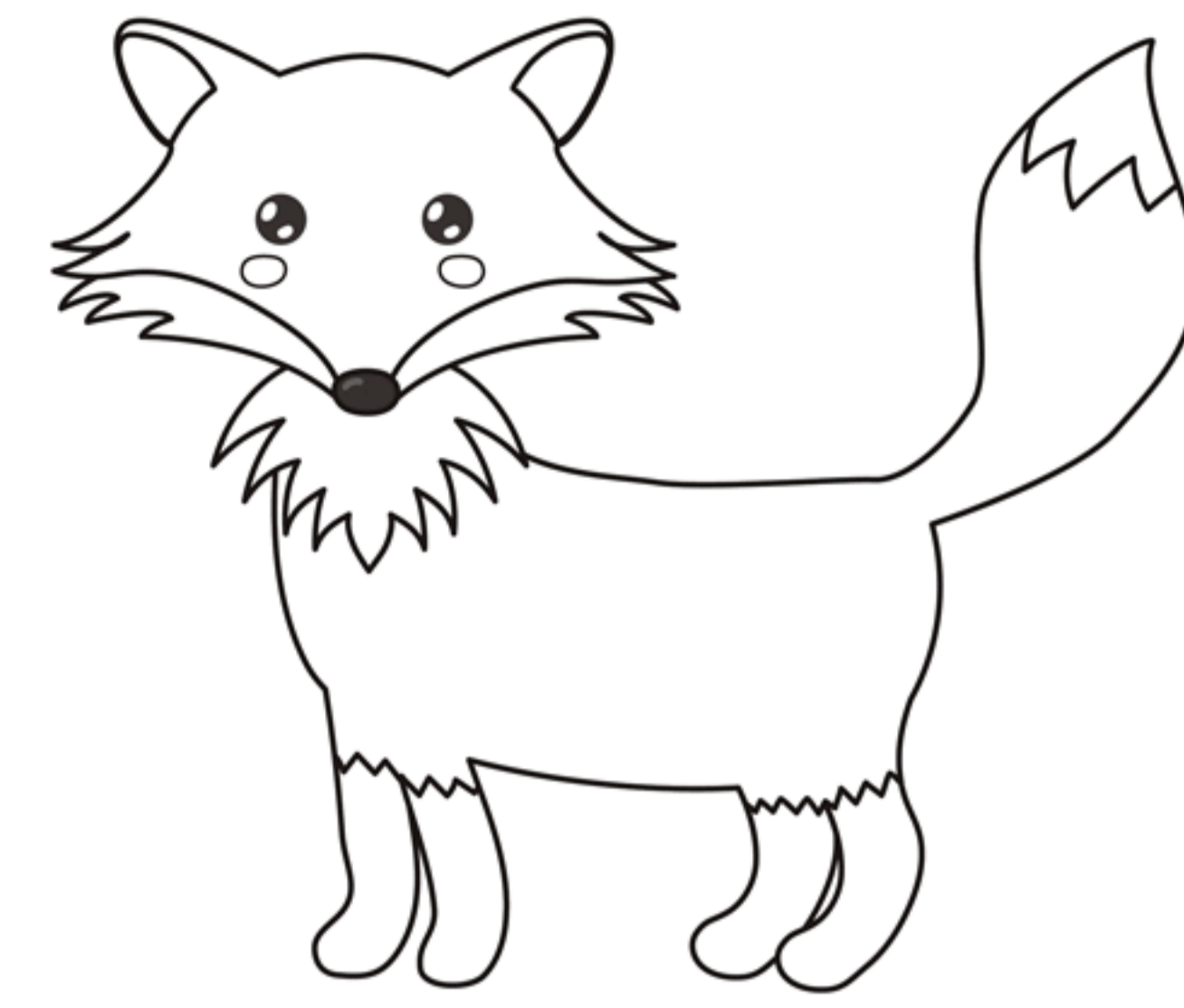

val

Questa è una copia
dimostrativa.

Tutti i nostri eBook possono
essere acquistati sul sito.

©Pianetabambini.it

ser ... ente

ba ... bino

... ruco

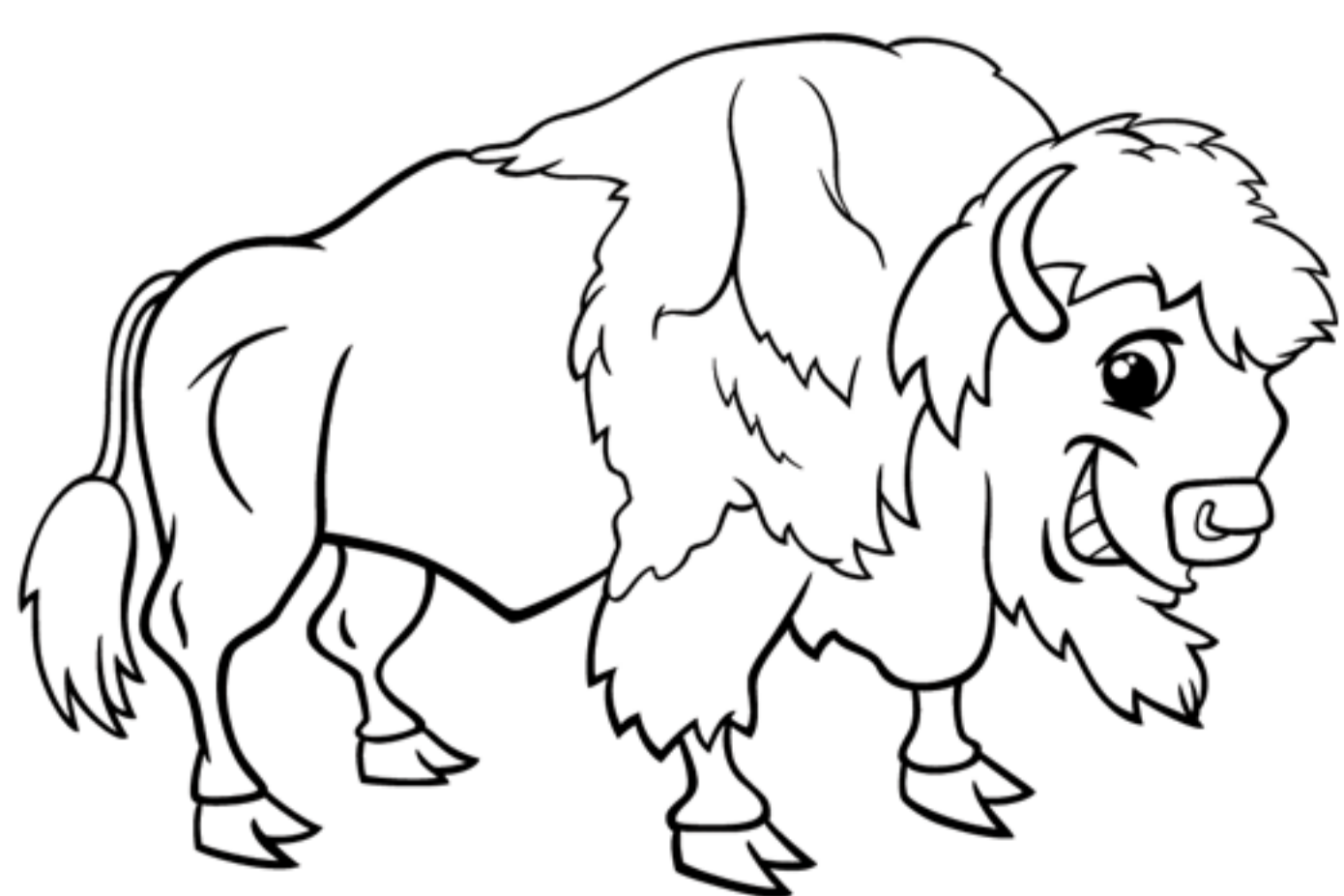

... isonte

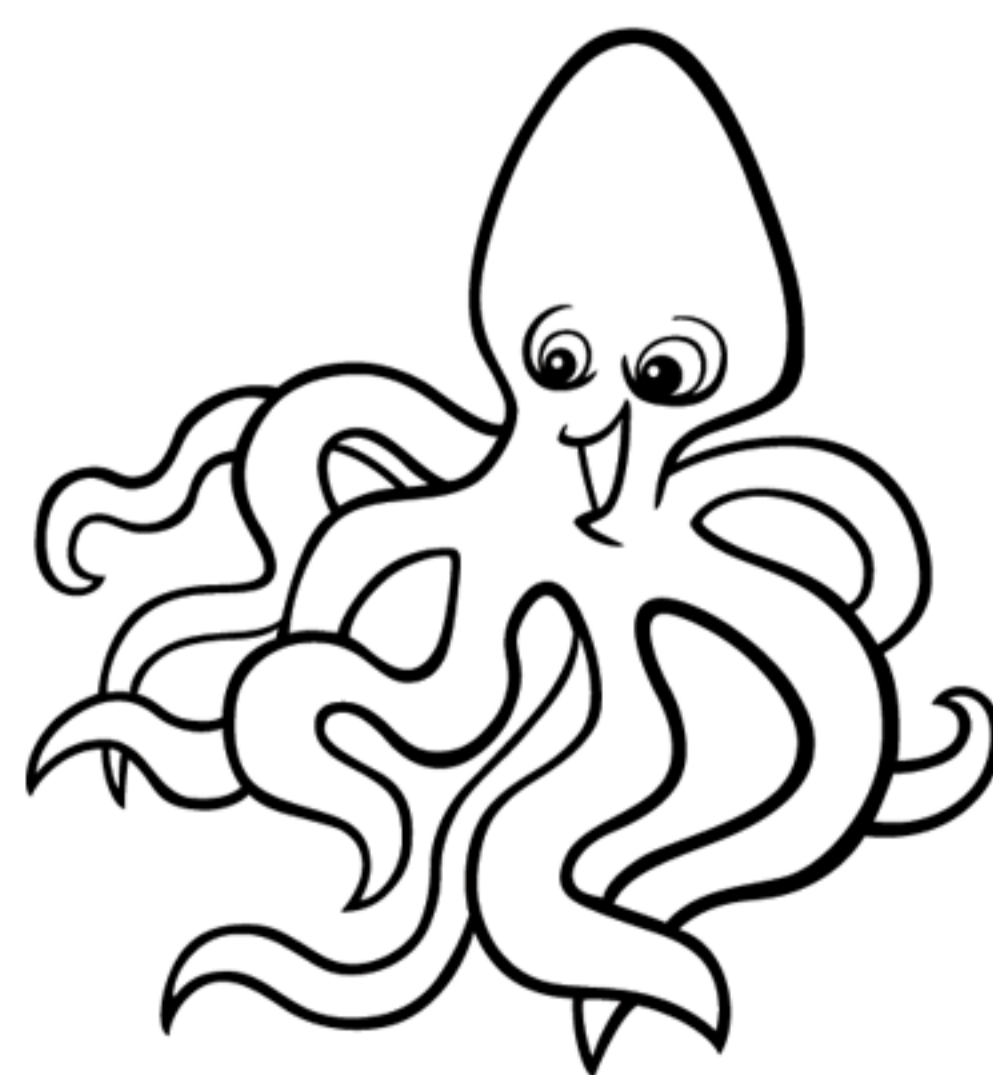

... olpo

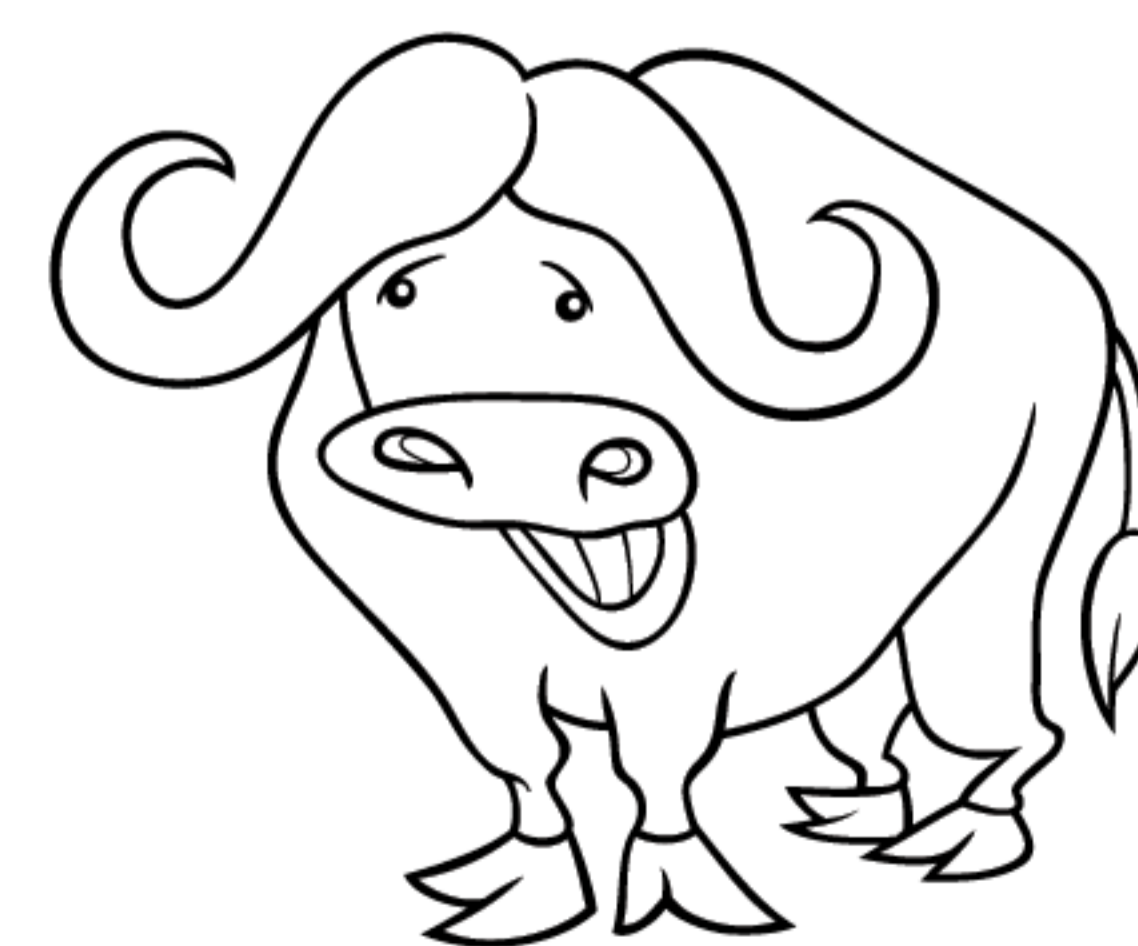

... ufalo

Suoni simili: B-P

- Completa le frasi con le parole raffigurate.

- Francesca è molto affezionata alla sua



- La è un frutto ricco di potassio

Questa è una copia
dimostrativa.
Tutti i nostri eBook possono
essere acquistati sul sito.

©Pianetabambini.it

- La lana si ricava dagli ovini come la

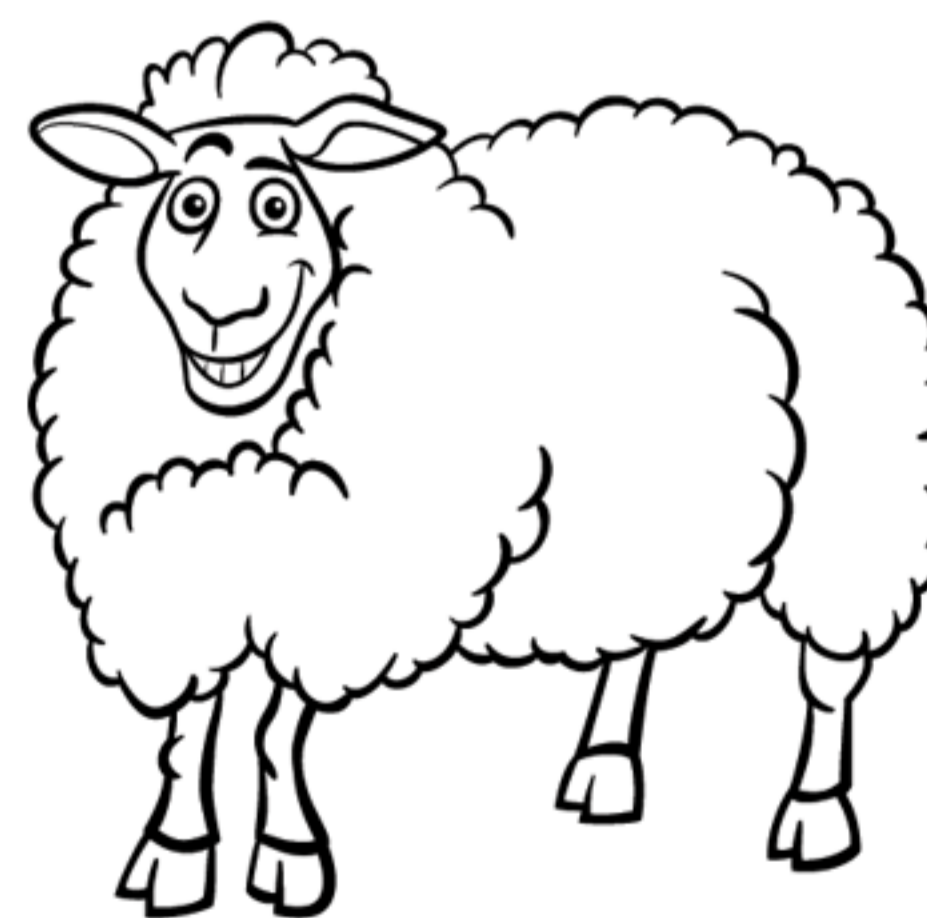

- La è molto più intelligente di quanto si pensi.



Suoni simili: D-T

- Completa le parole con D o T.

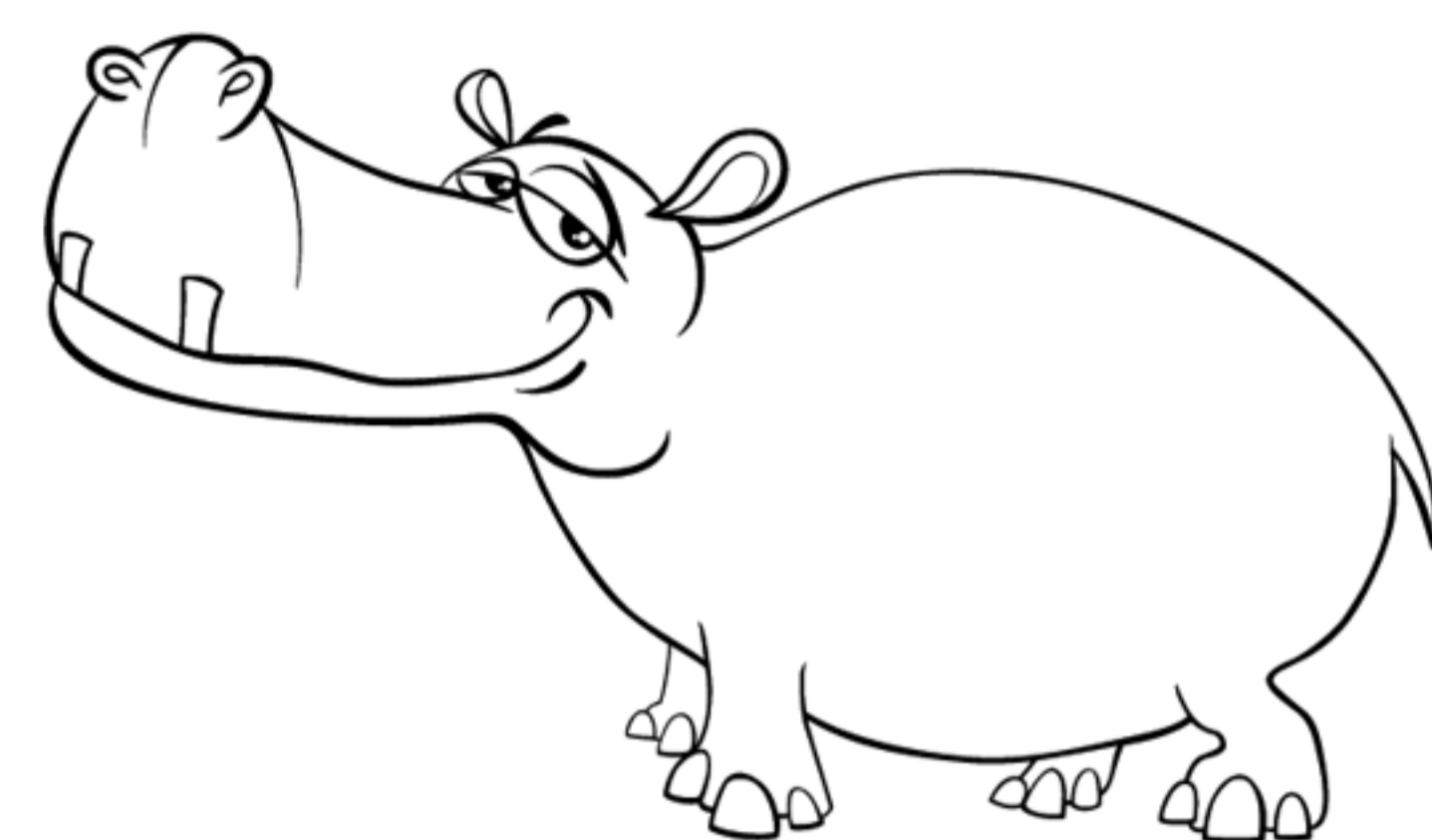
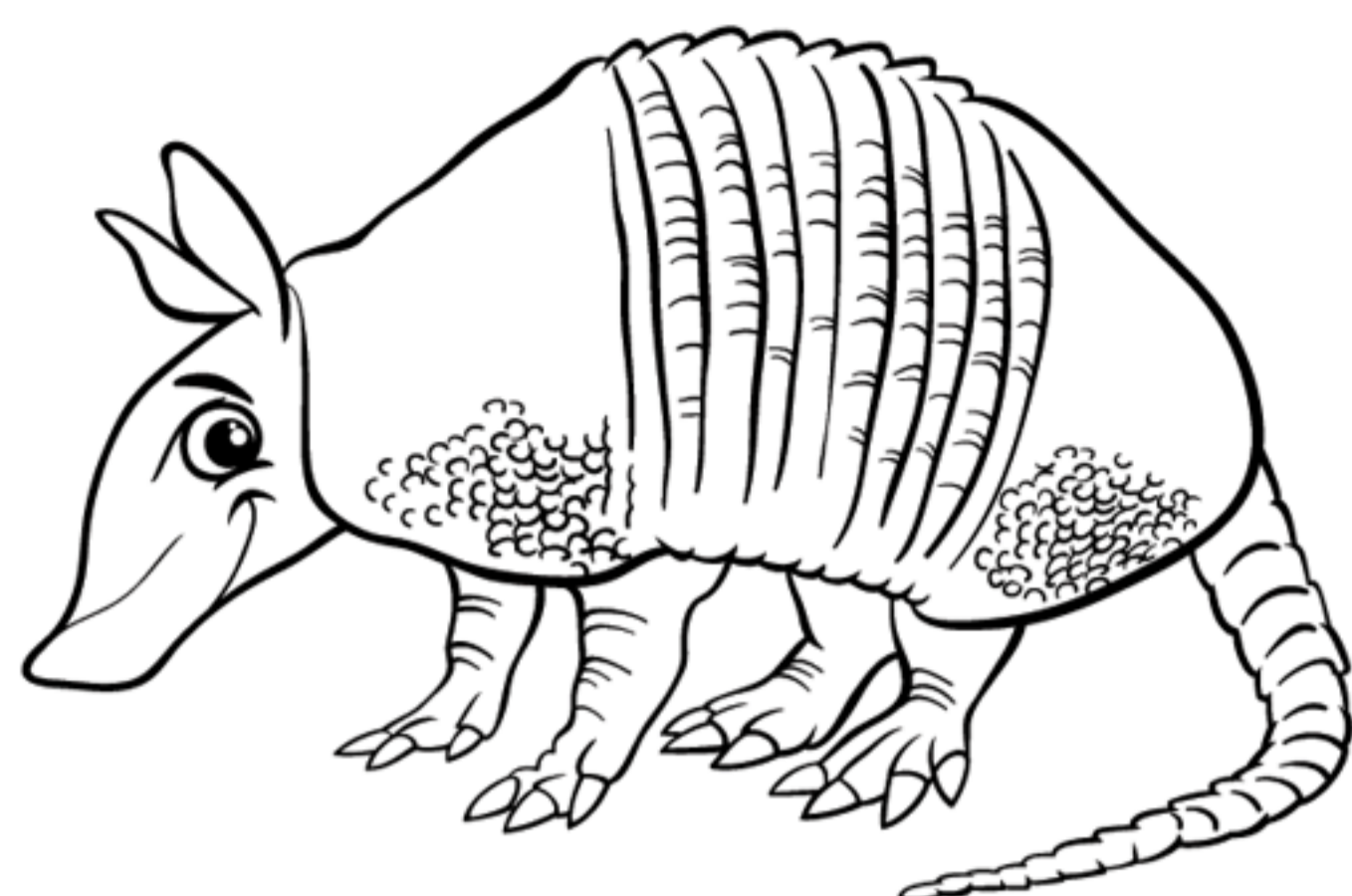
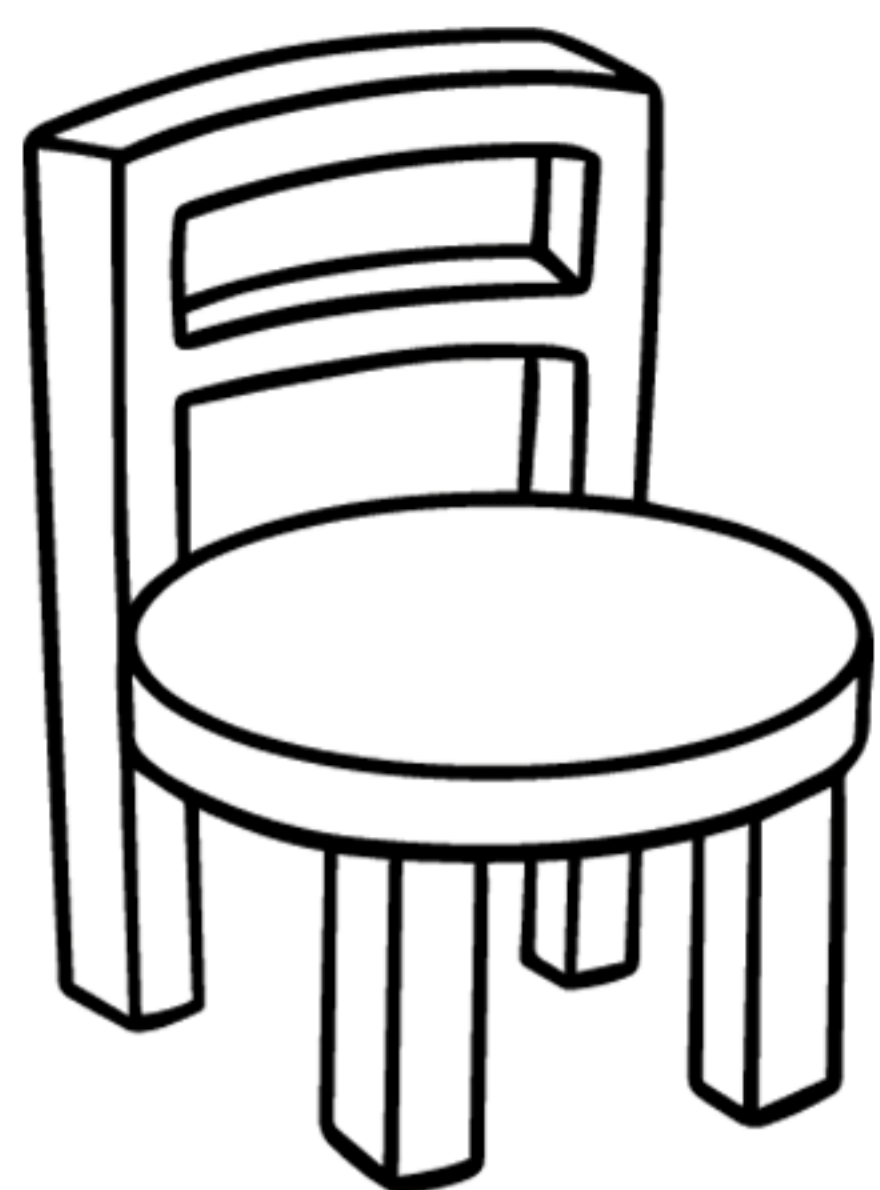

ca ... ia

ar ... illo

ipp ... amo

Questa è una copia
dimostrativa.

Tutti i nostri eBook possono
essere acquistati sul sito.

©Pianetabambini.it

... oro

... elefono

... elfino

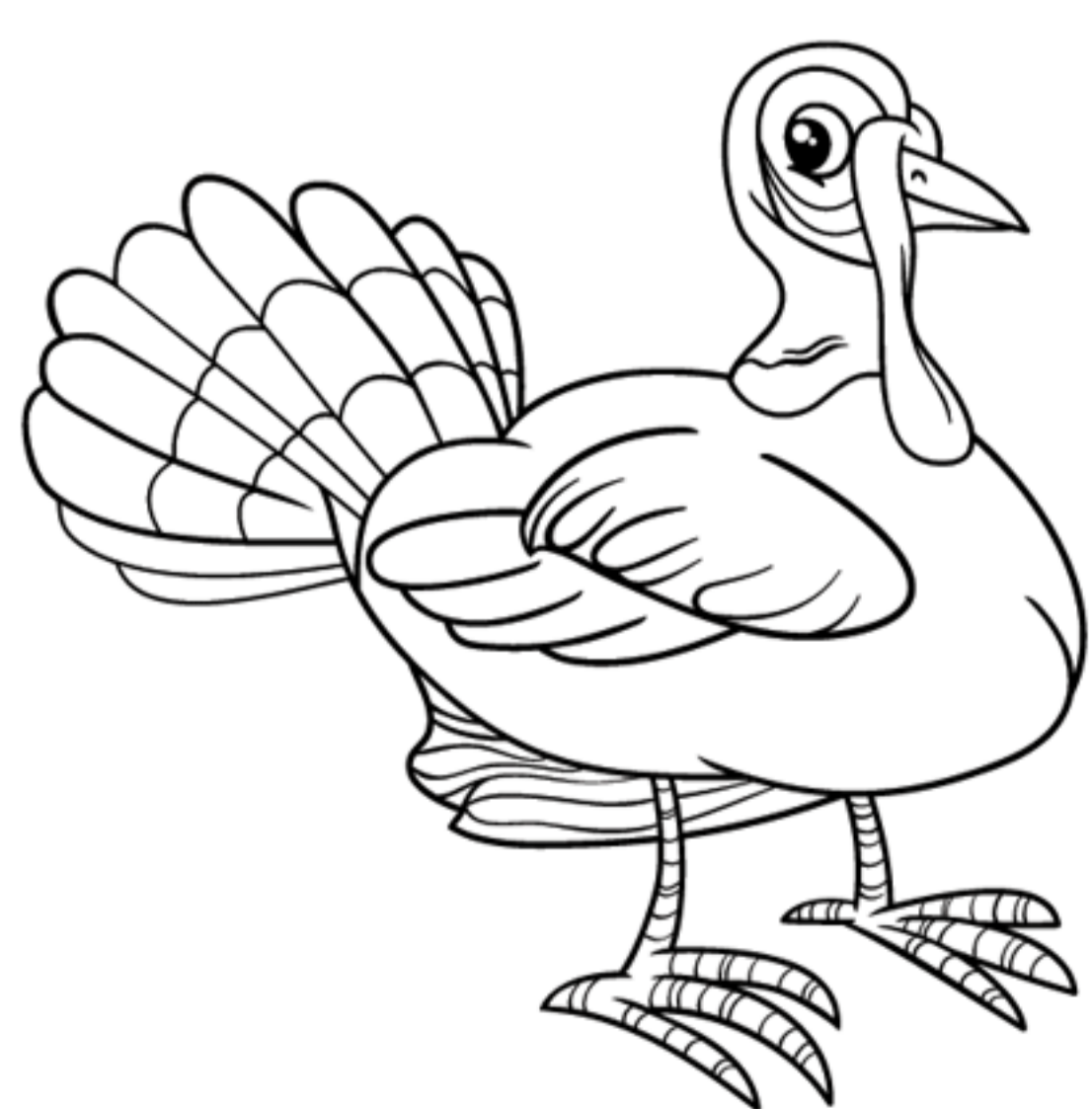

... acchino

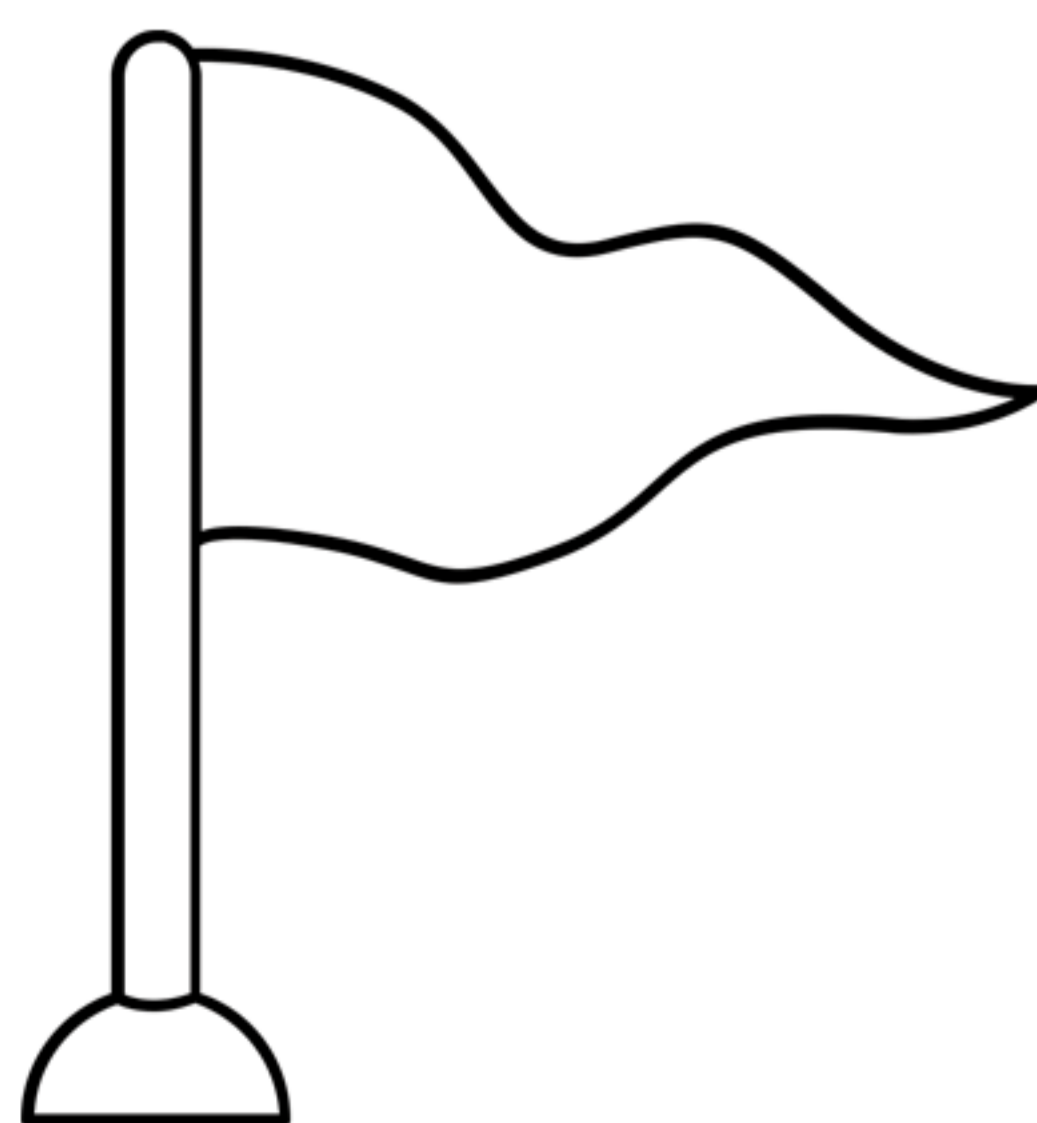

ban ... iera

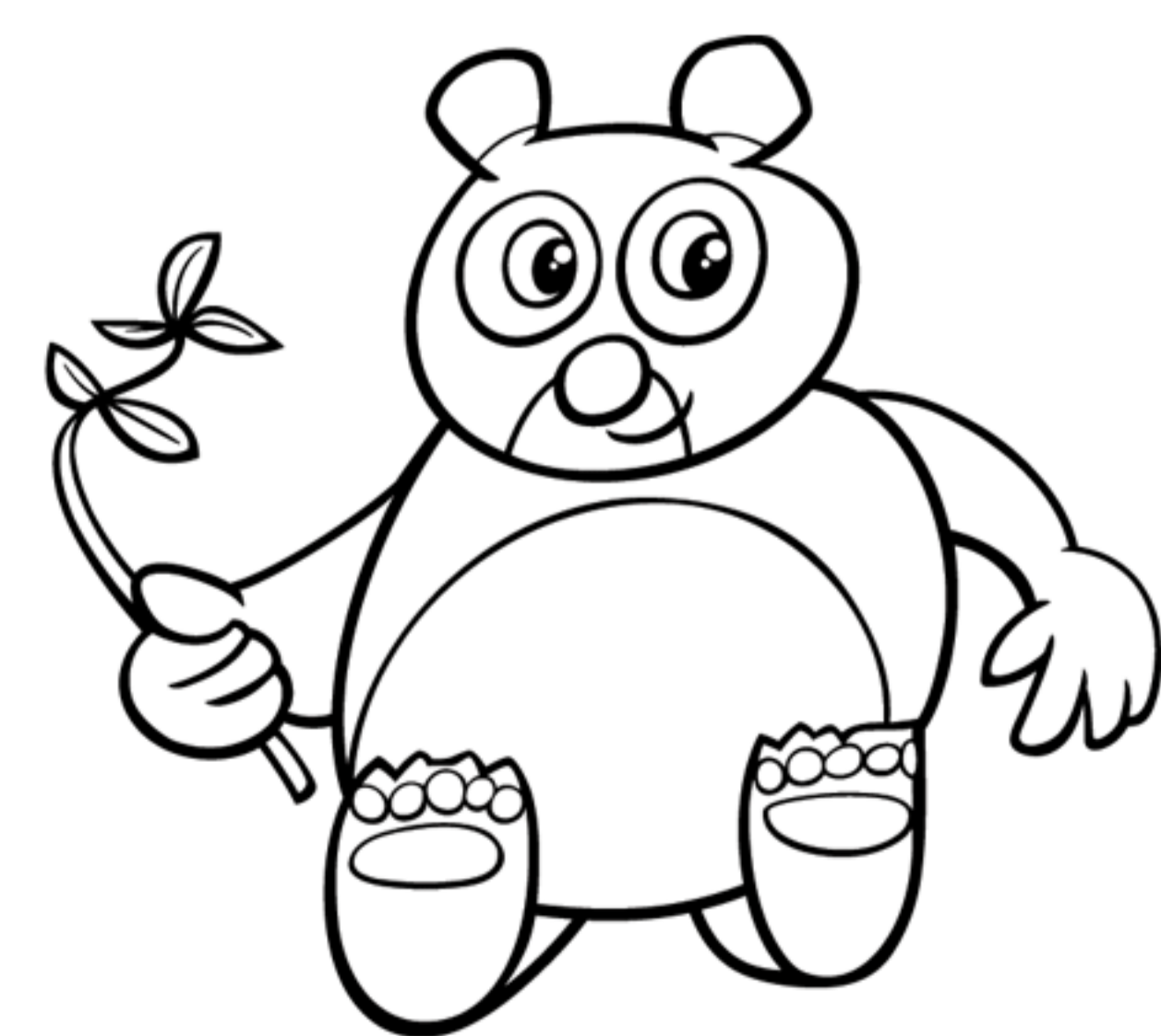

... anda

Suoni simili: D-T

- Completa le parole con D o T.

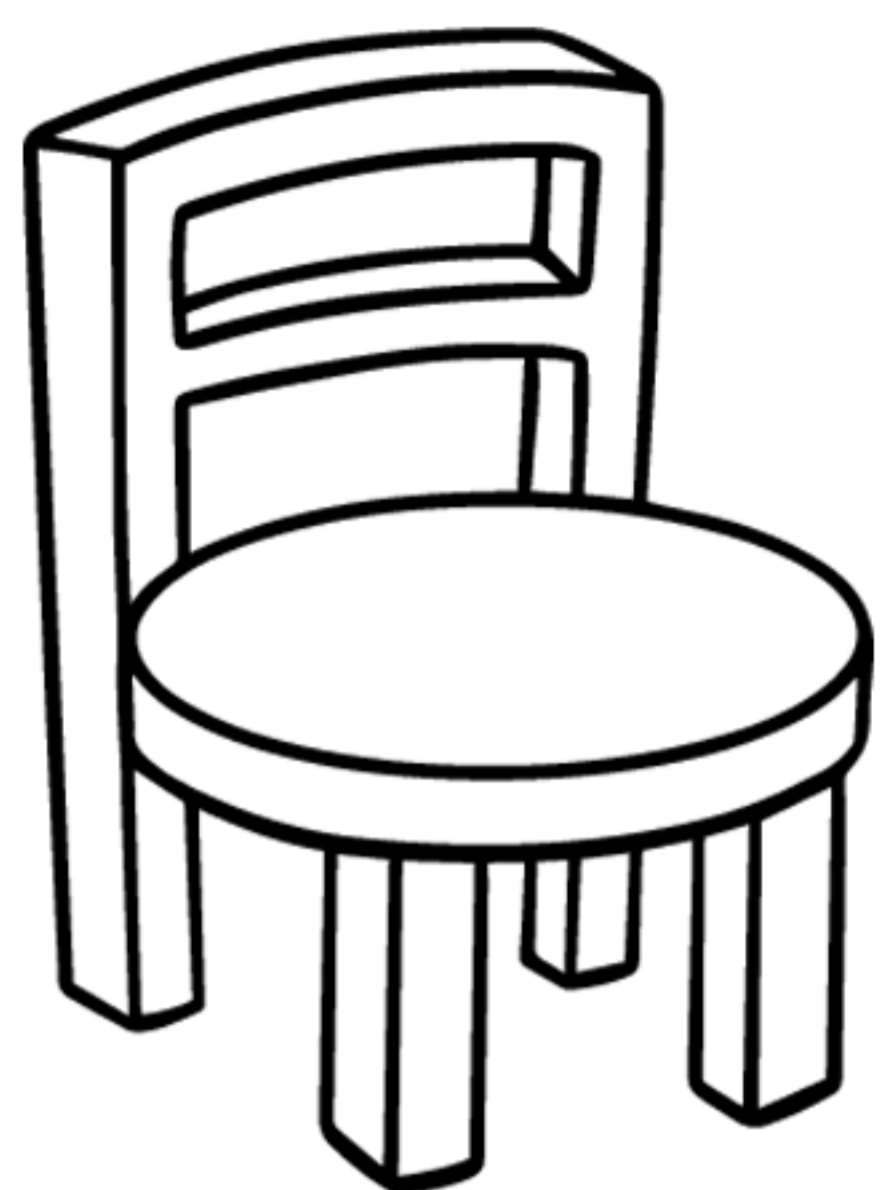

ca ... ia

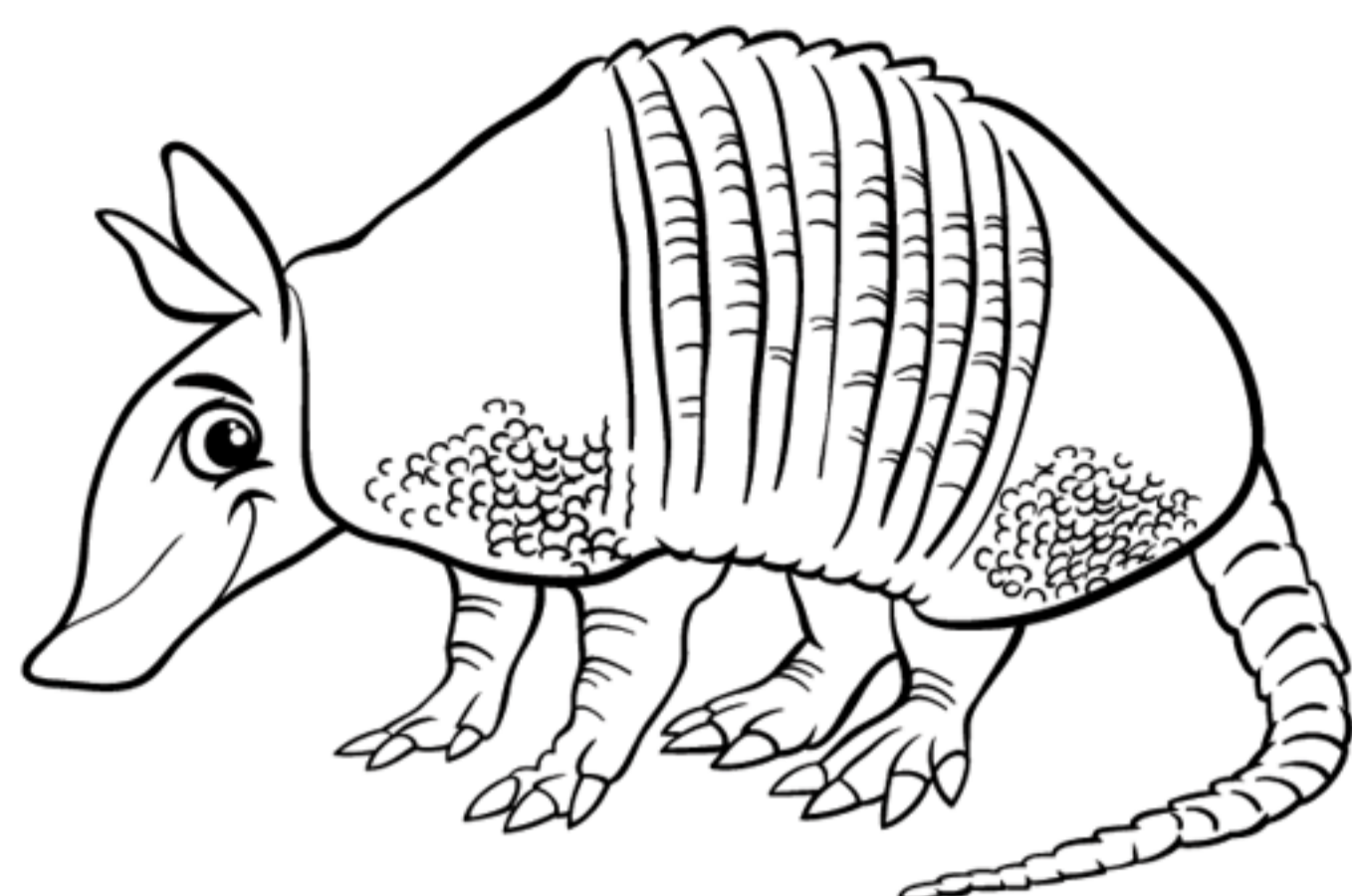

ar ... illo

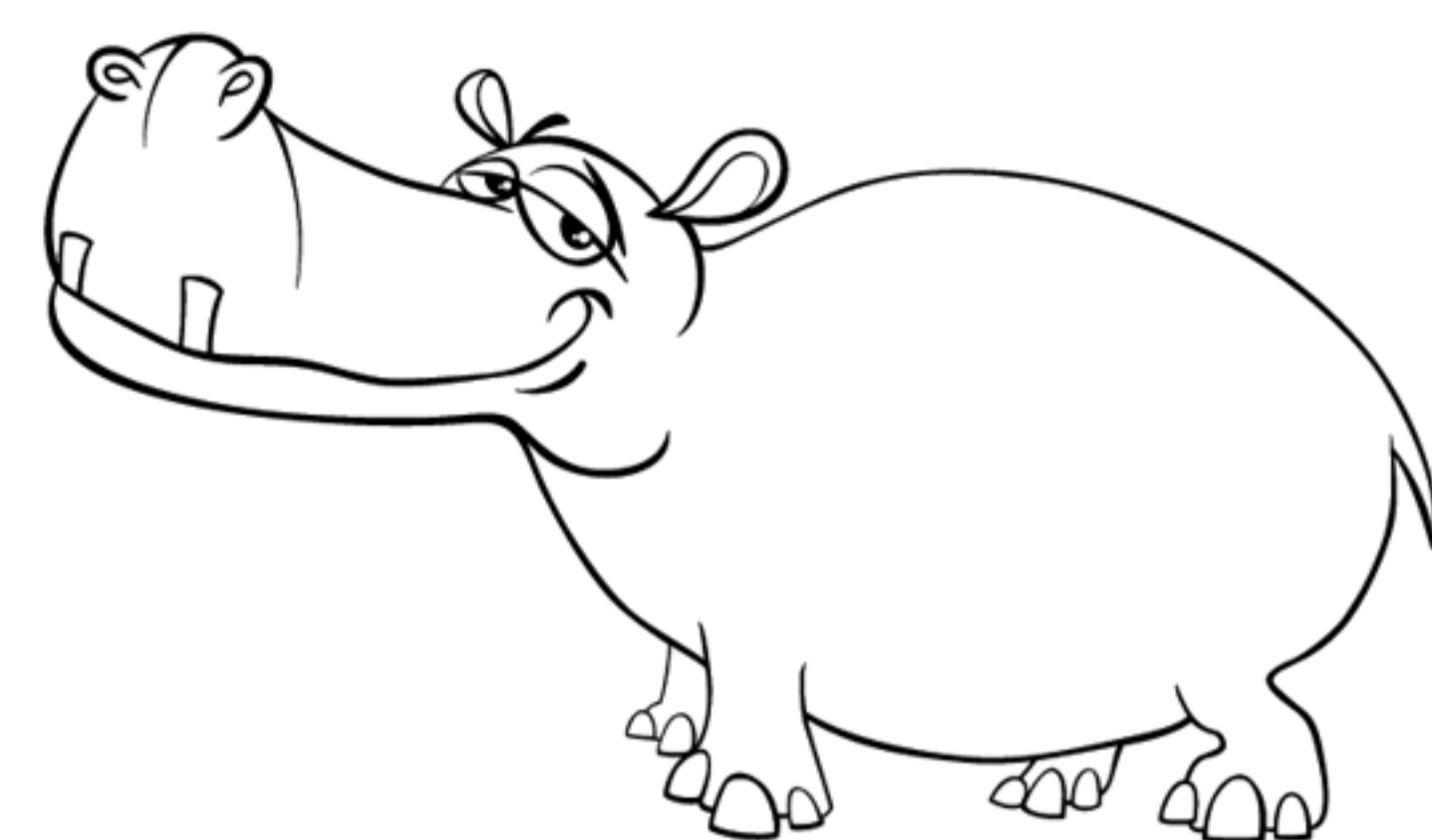

ipp ... amo

Questa è una copia
dimostrativa.

Tutti i nostri eBook possono
essere acquistati sul sito.

©Pianetabambini.it

... oro

... elefono

... elfino

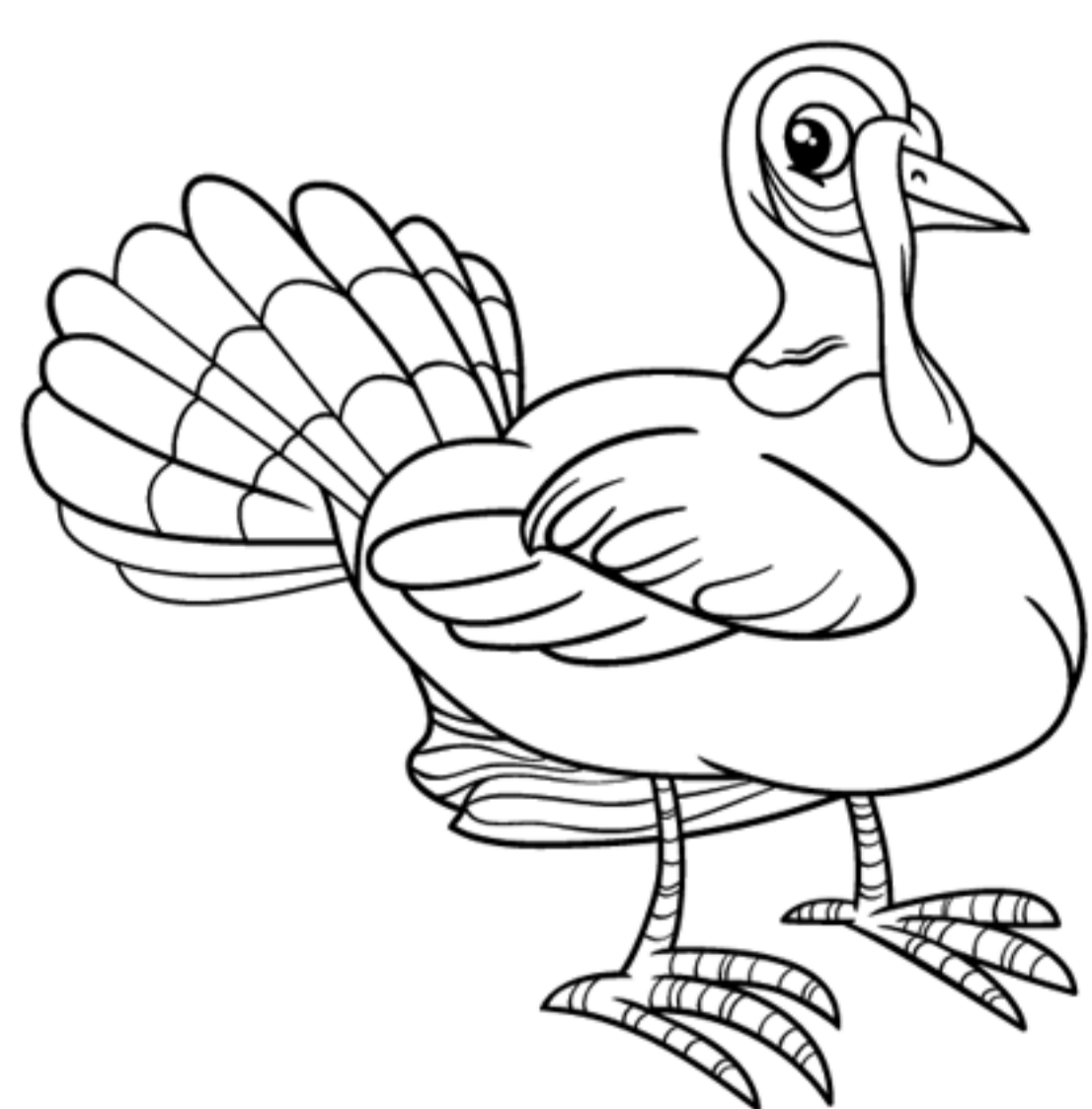

... acchino

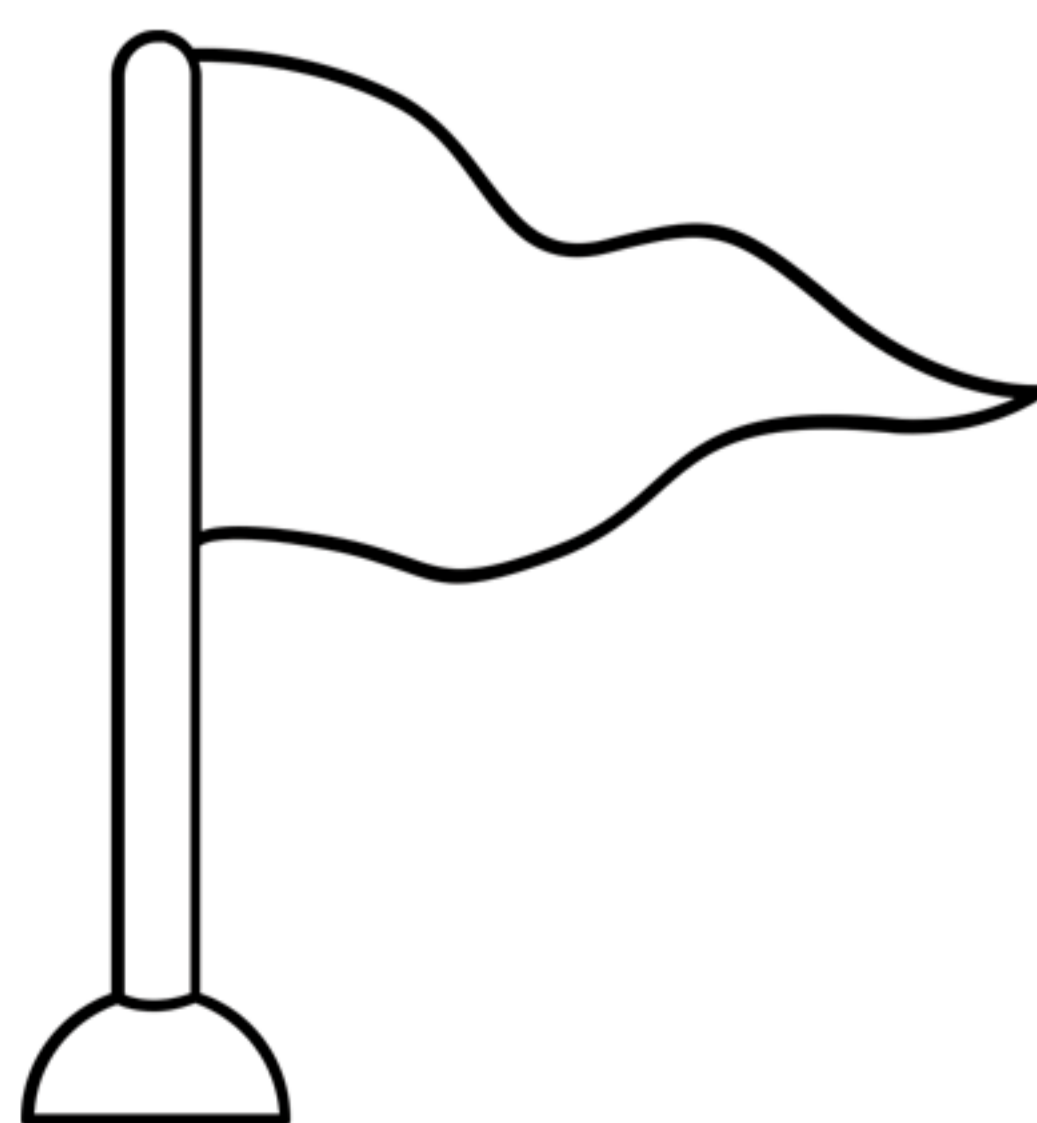

ban ... iera

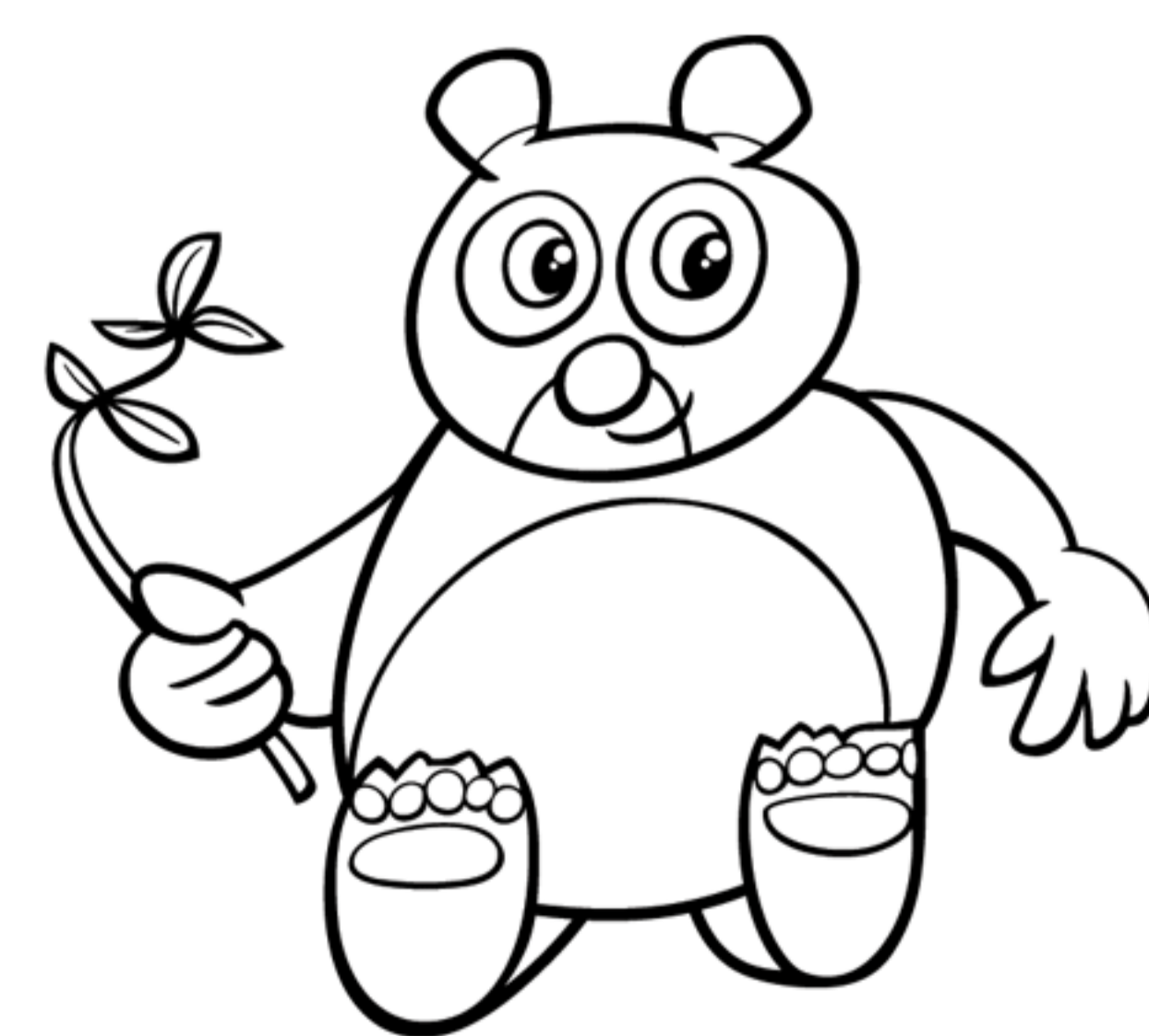

... anda

Suoni simili: L-R

- Completa le parole con L o R.

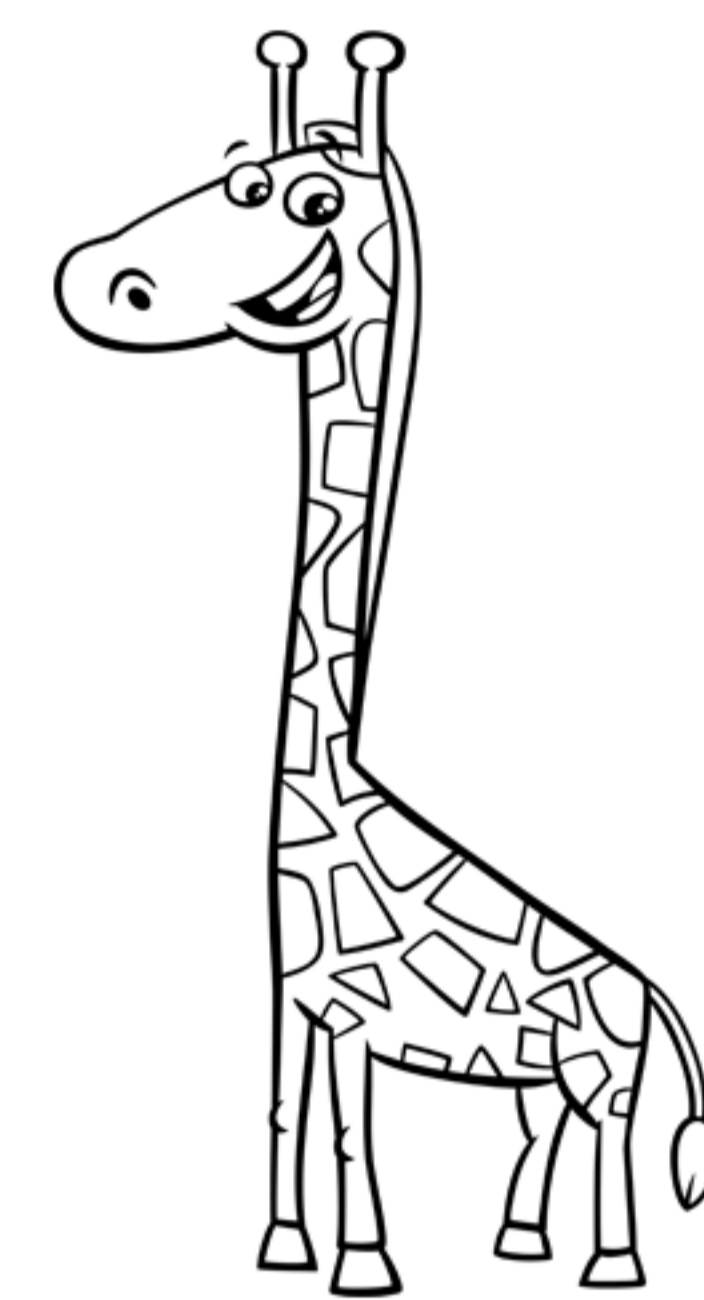
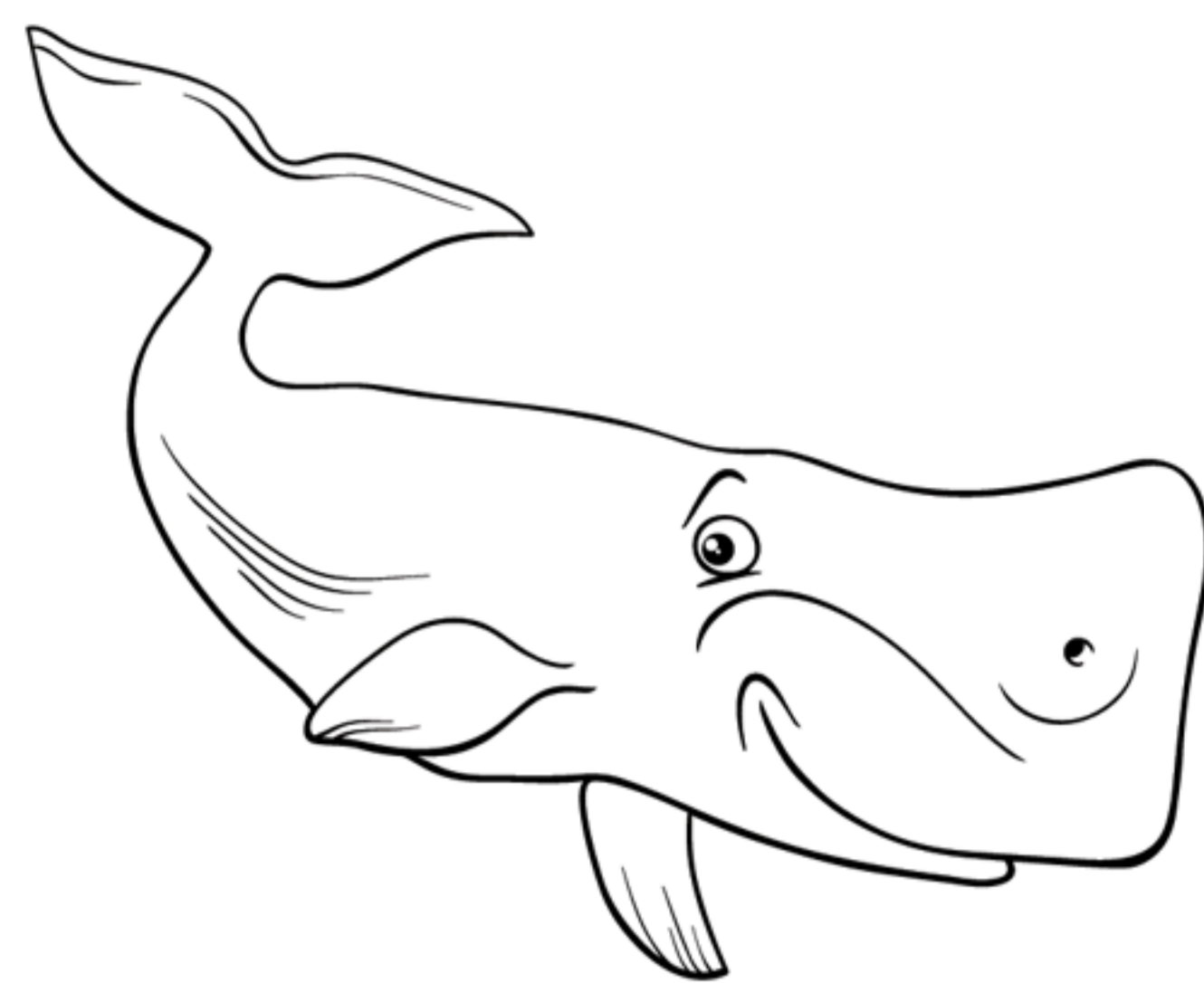
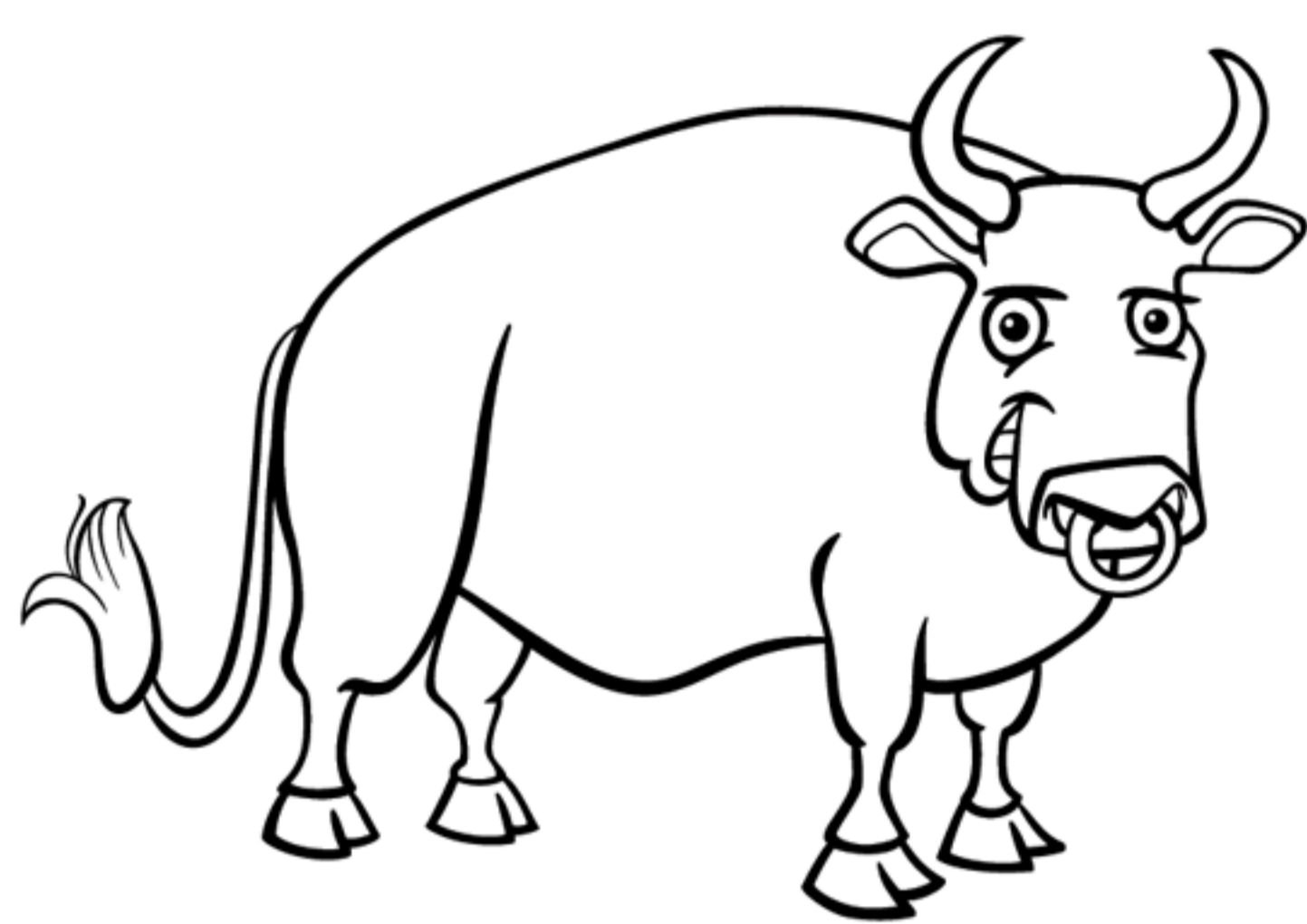

Questa è una copia
dimostrativa.

Tutti i nostri eBook possono
essere acquistati sul sito.

©Pianetabambini.it

se ... pente

scoiatto ... o

go ... illa

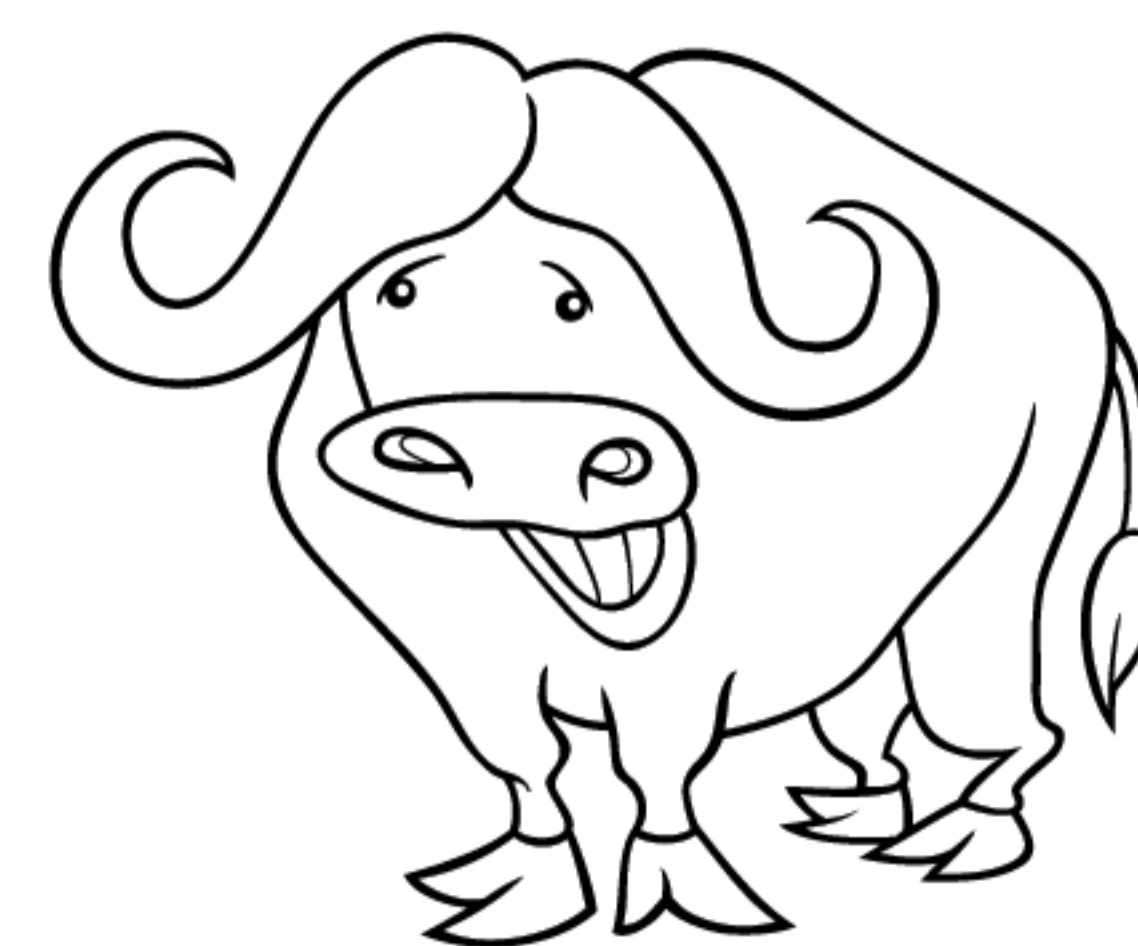
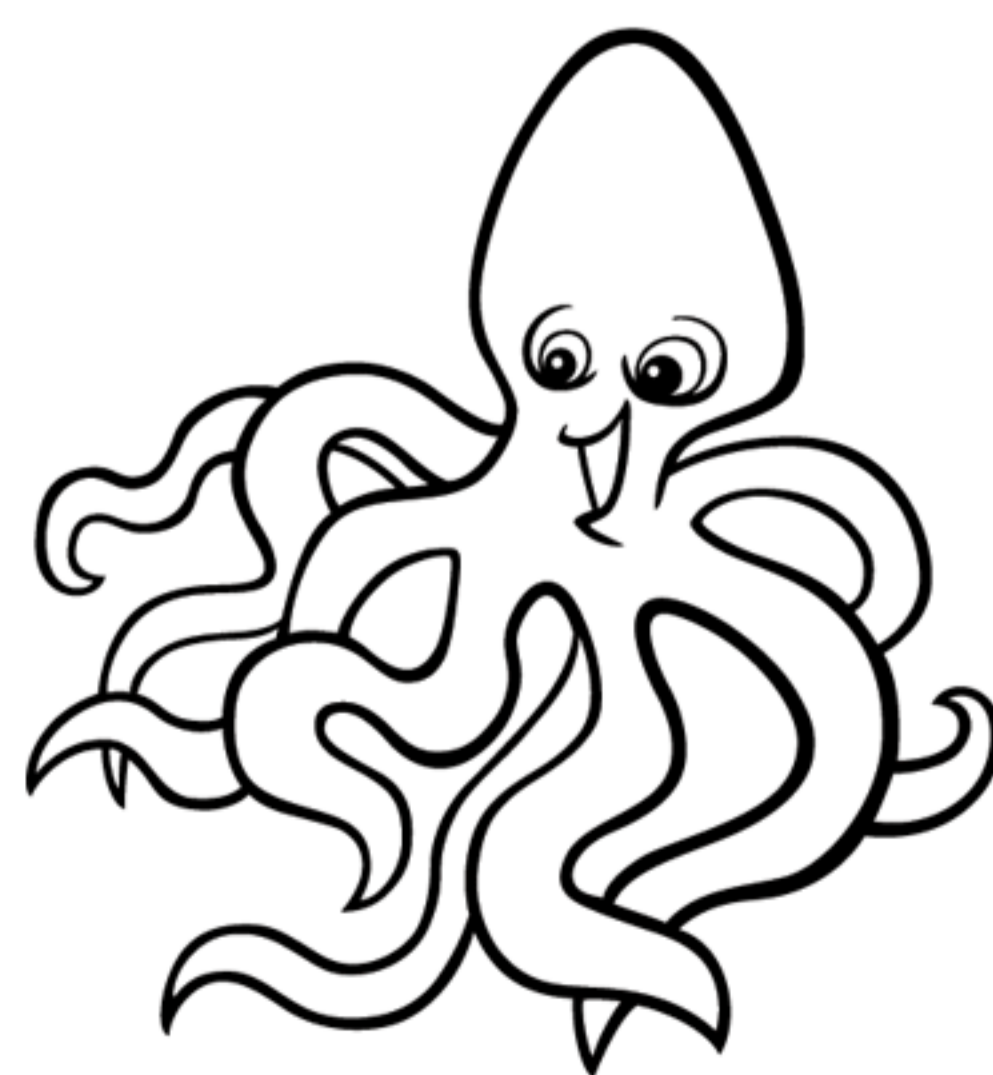
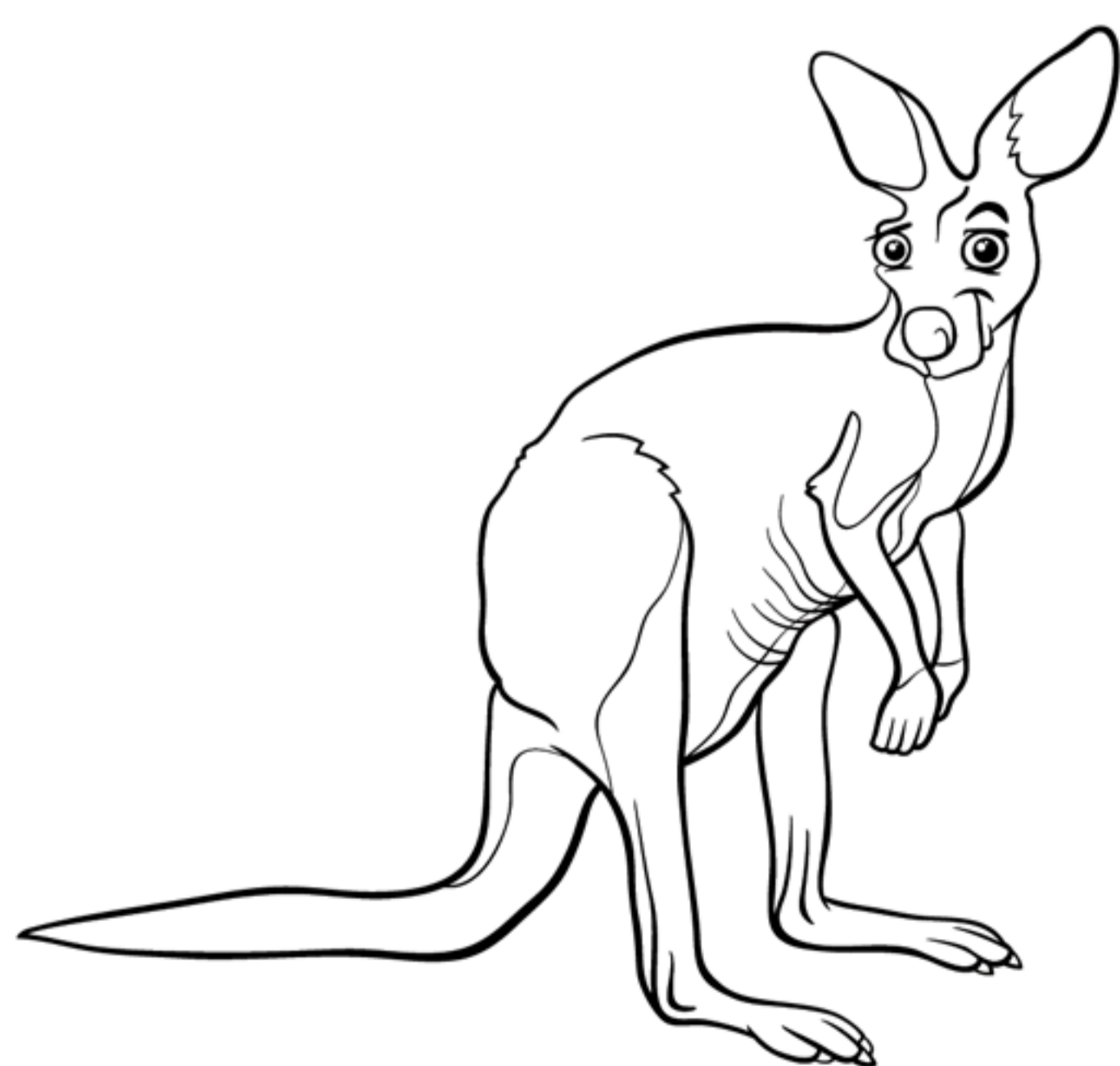

cangu ... o

po ... po

bufa ... o

Suoni simili: L-R

- Completa le frasi con le parole raffigurate.

- L'animale più grande sulla terra è l'

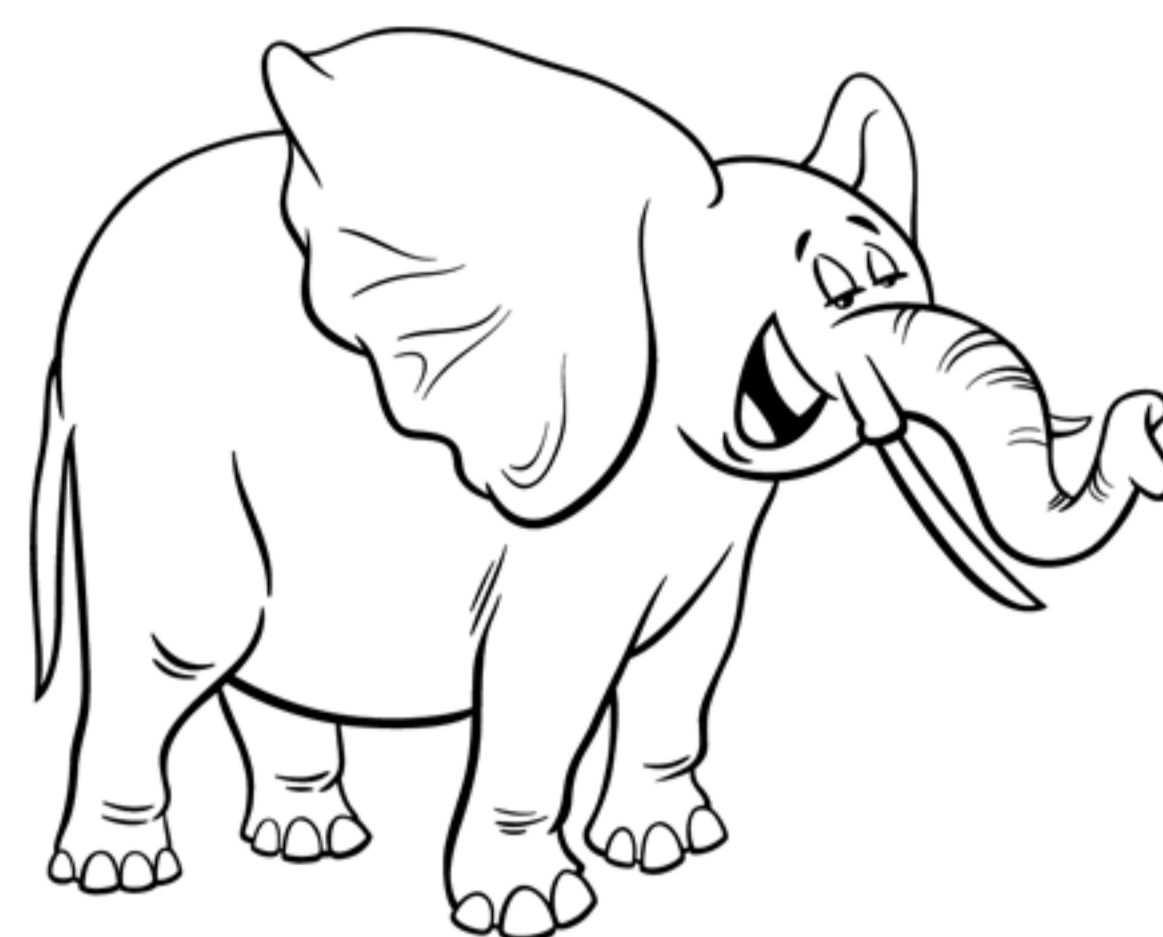

.....

- Il



vive in branchi numerosi

Questa è una copia
dimostrativa.

Tutti i nostri eBook possono
essere acquistati sul sito.

©Pianetabambini.it

- Il nettare è il cibo preferito della

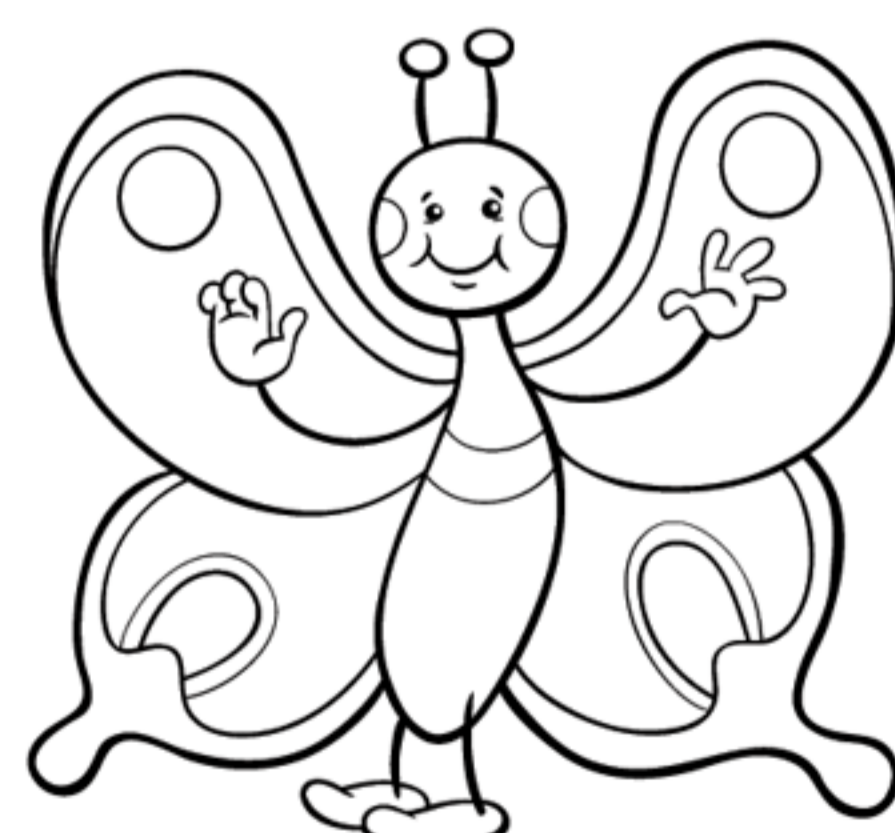

.....

- La

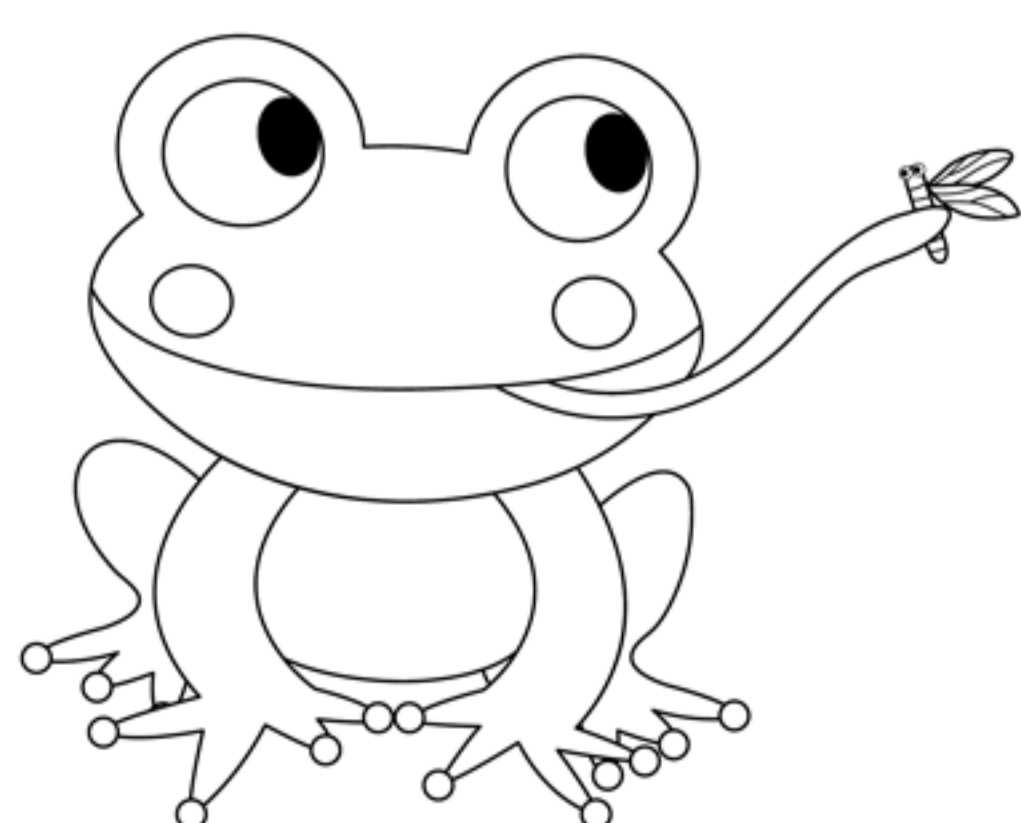

..... cattura le sue prede con la lingua.

Suoni simili: M-N

- Completa le parole con M o N.

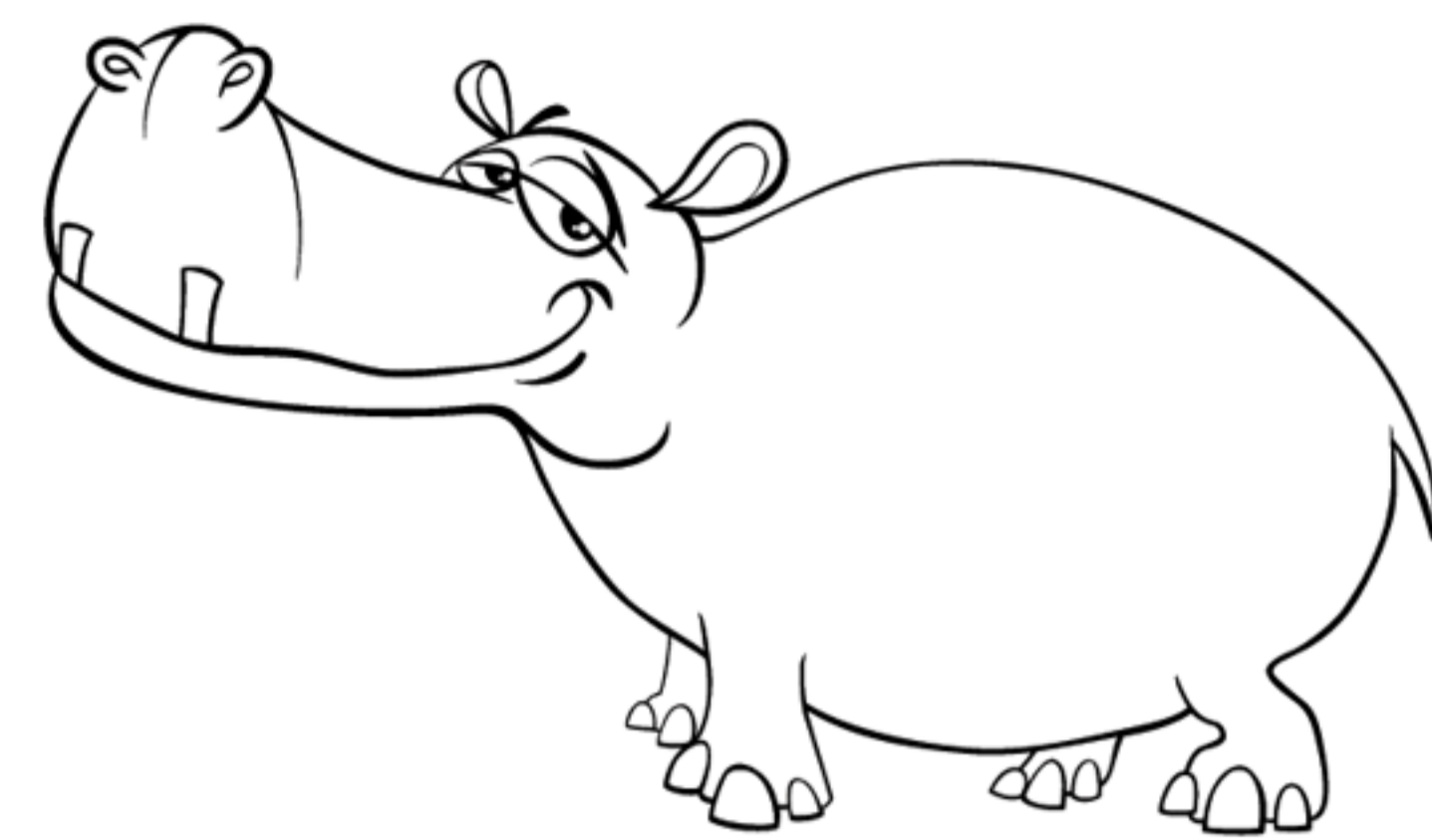
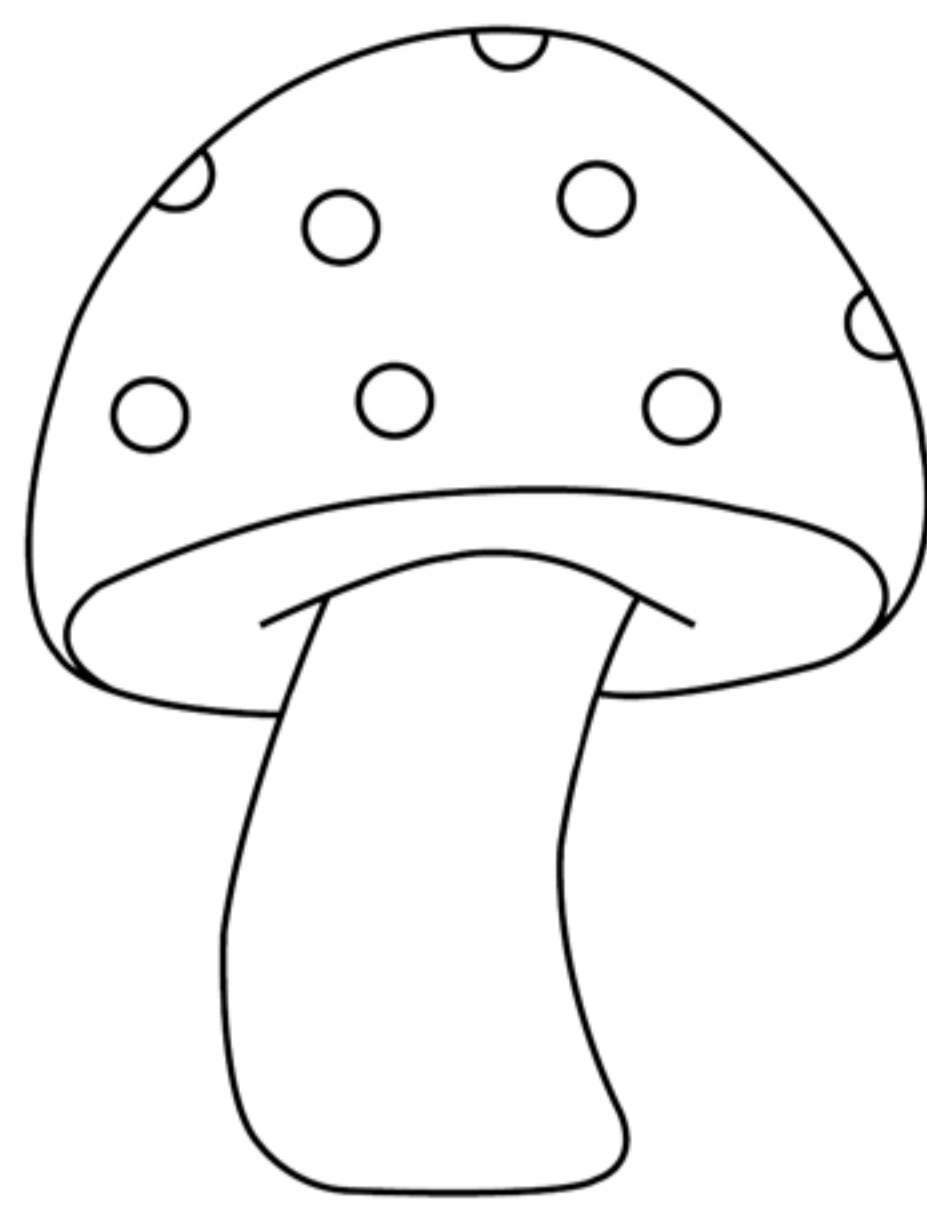
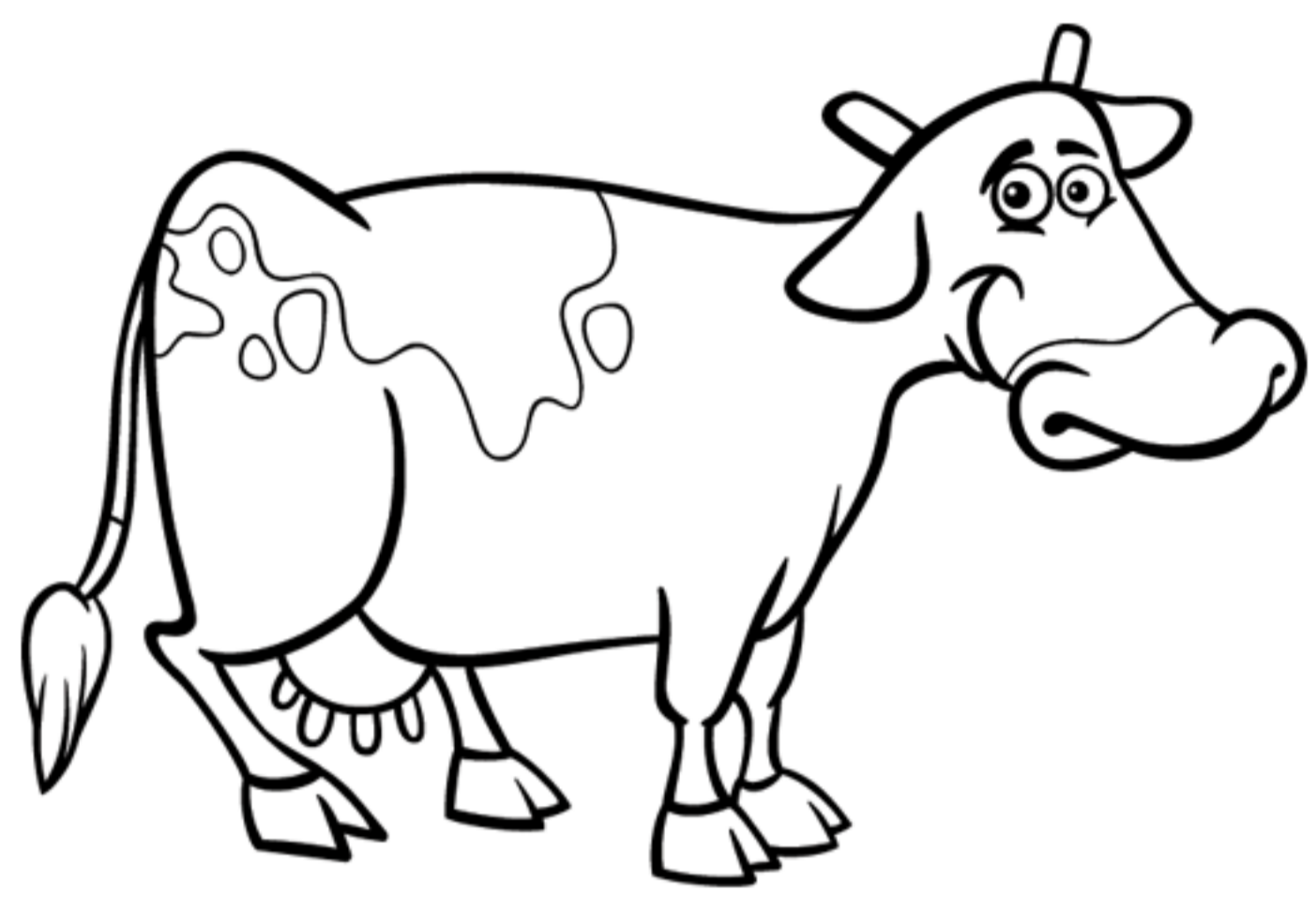

uoca

fu ... o

in ... o

Questa è una copia
dimostrativa.

Tutti i nostri eBook possono
essere acquistati sul sito.

©Pianetabambini.it

for ... ica

telefo ... o

ba ... bino

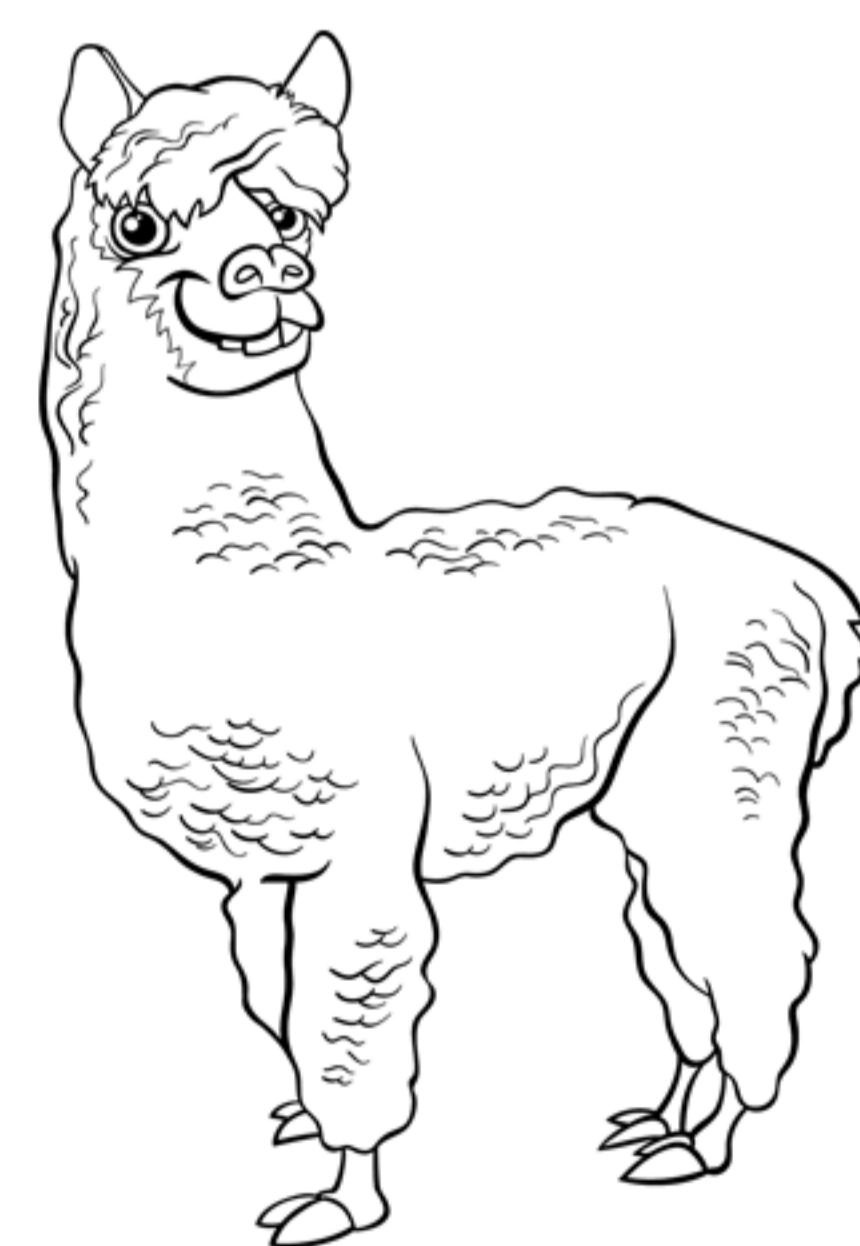
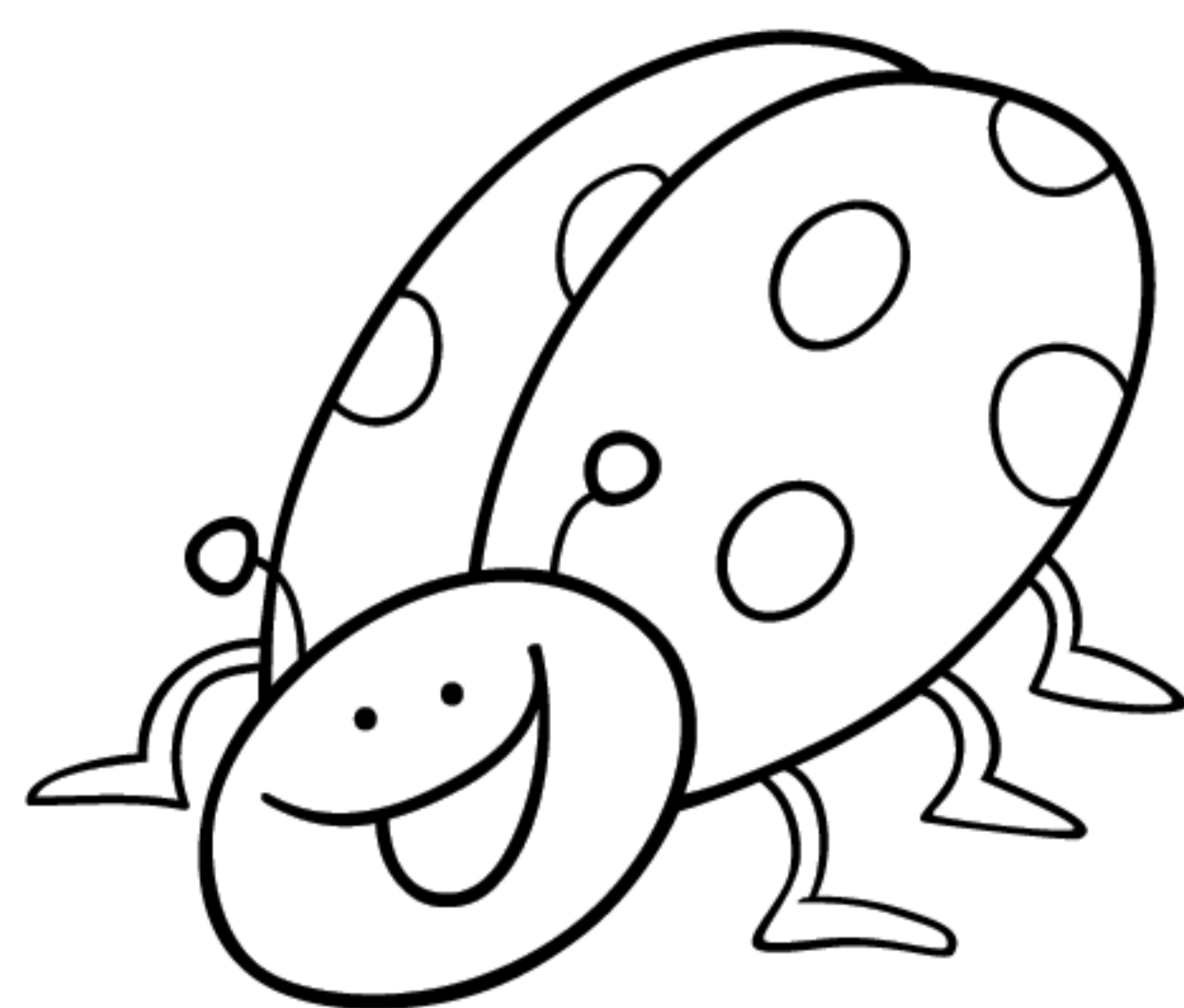
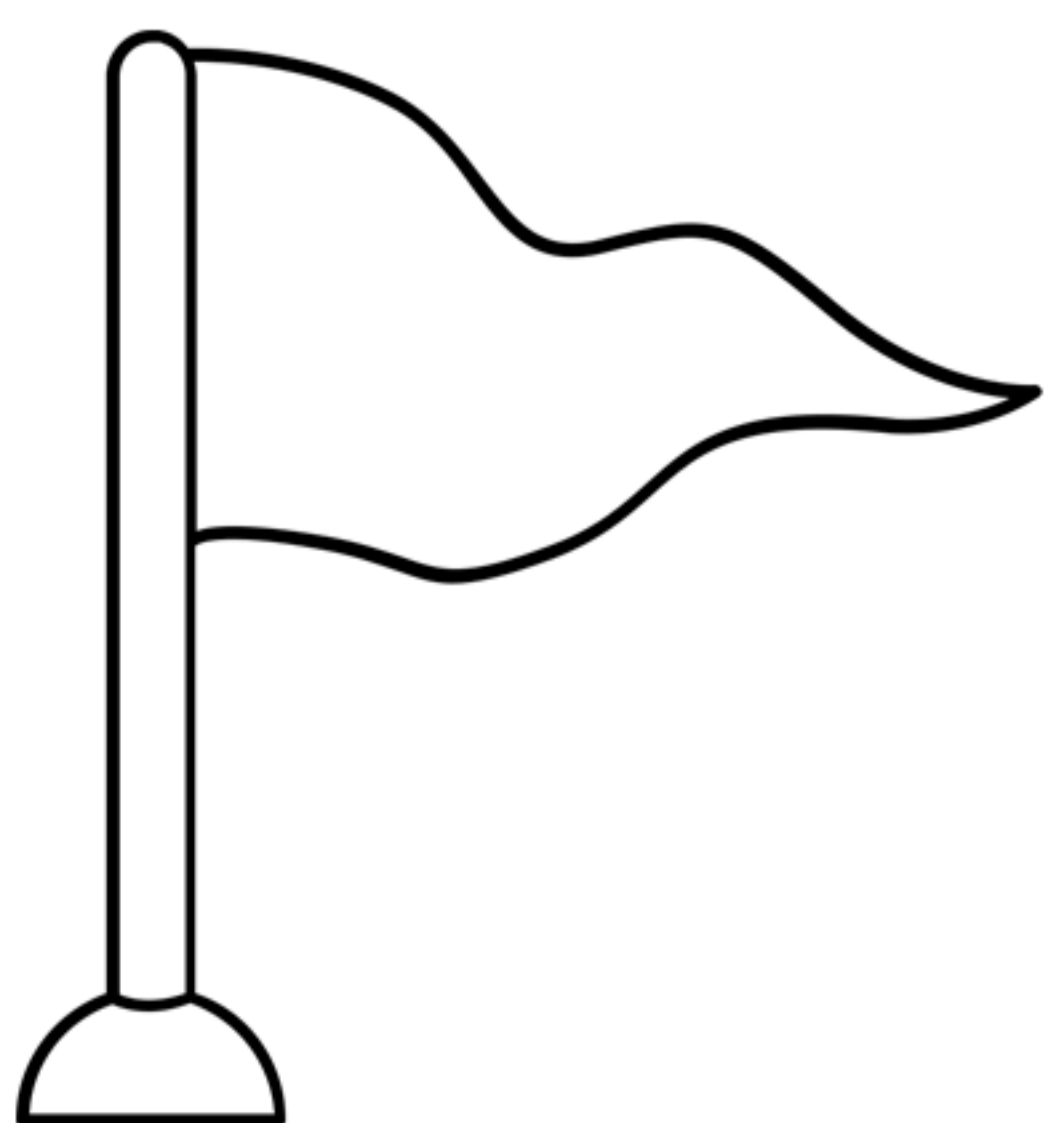

ba ... diera

cocci ... ella

la ... a

Suoni simili: M-N

- Completa le frasi con le parole raffigurate.

- Mio zio suona il  in una banda musicale.

- L'  è il frutto preferito di Marta

Questa è una copia
dimostrativa.

Tutti i nostri eBook possono
essere acquistati sul sito.

©Pianetabambini.it

- Andrea è un grande appassionato di 

- La  è ripartita carichissima di merce.

Suoni simili: S-Z

- Completa le parole con S o Z.

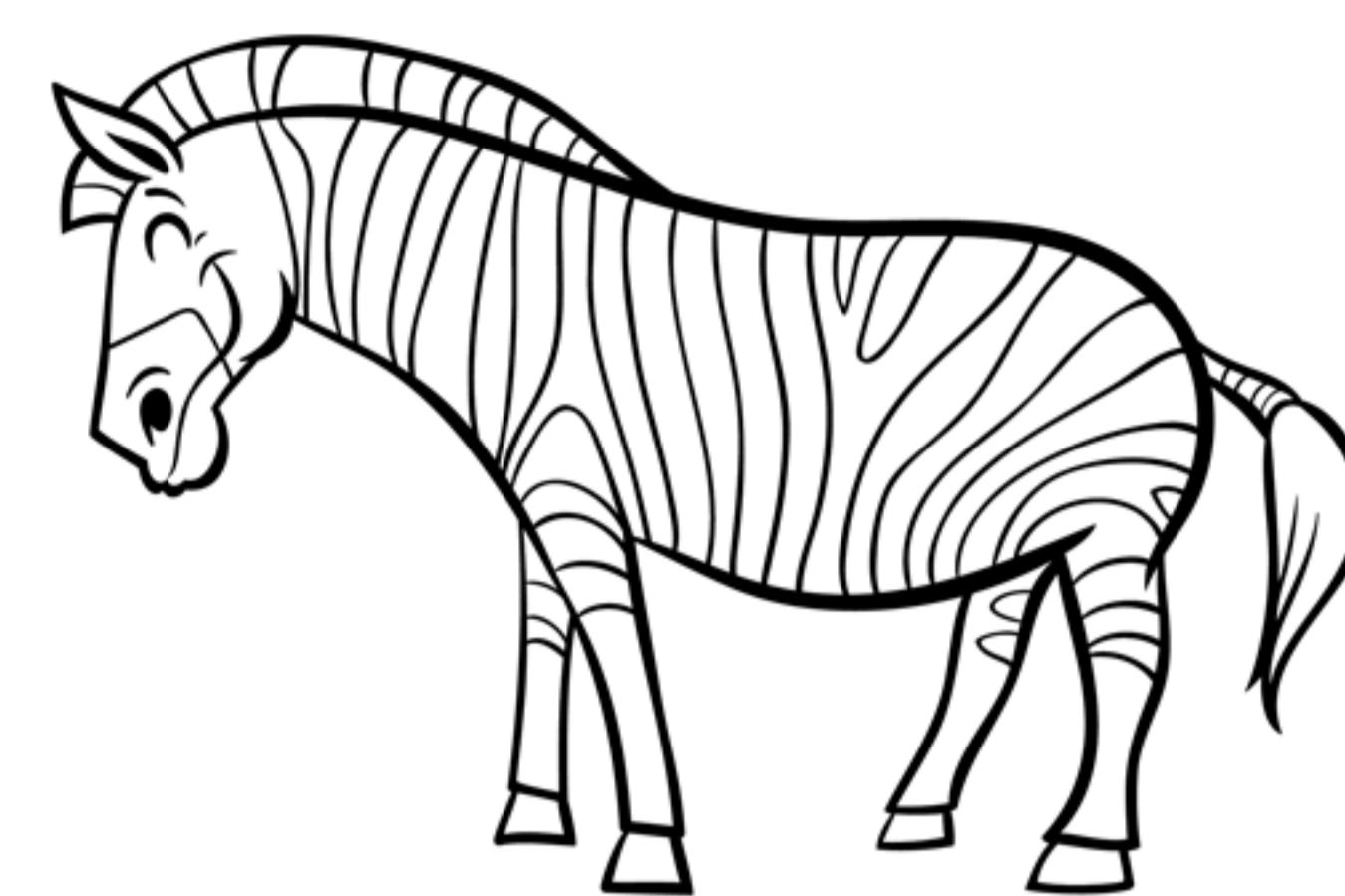
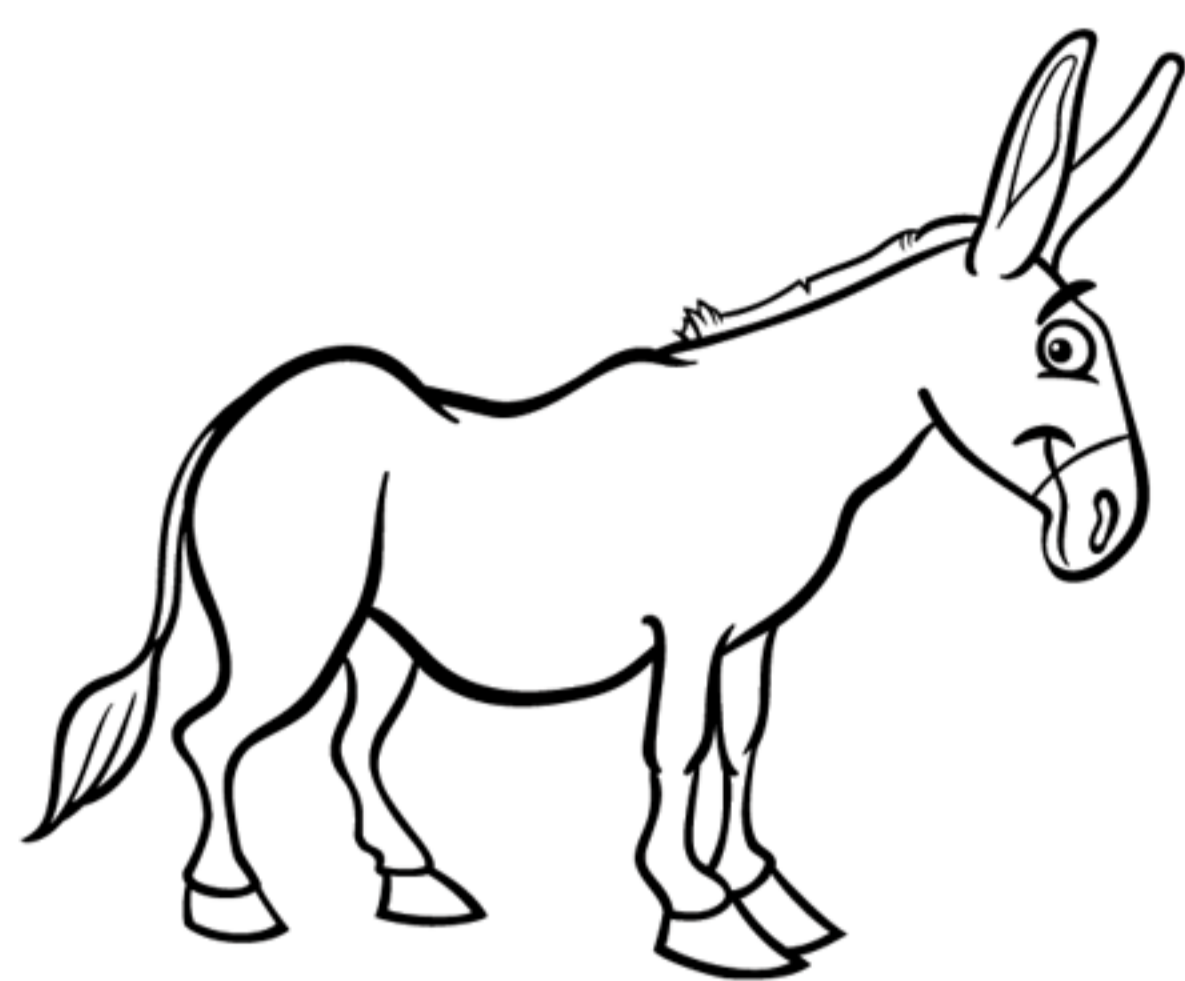

Questa è una copia
dimostrativa.

Tutti i nostri eBook possono
essere acquistati sul sito.

©Pianetabambini.it

... erpente

an ... iano

medu ... a

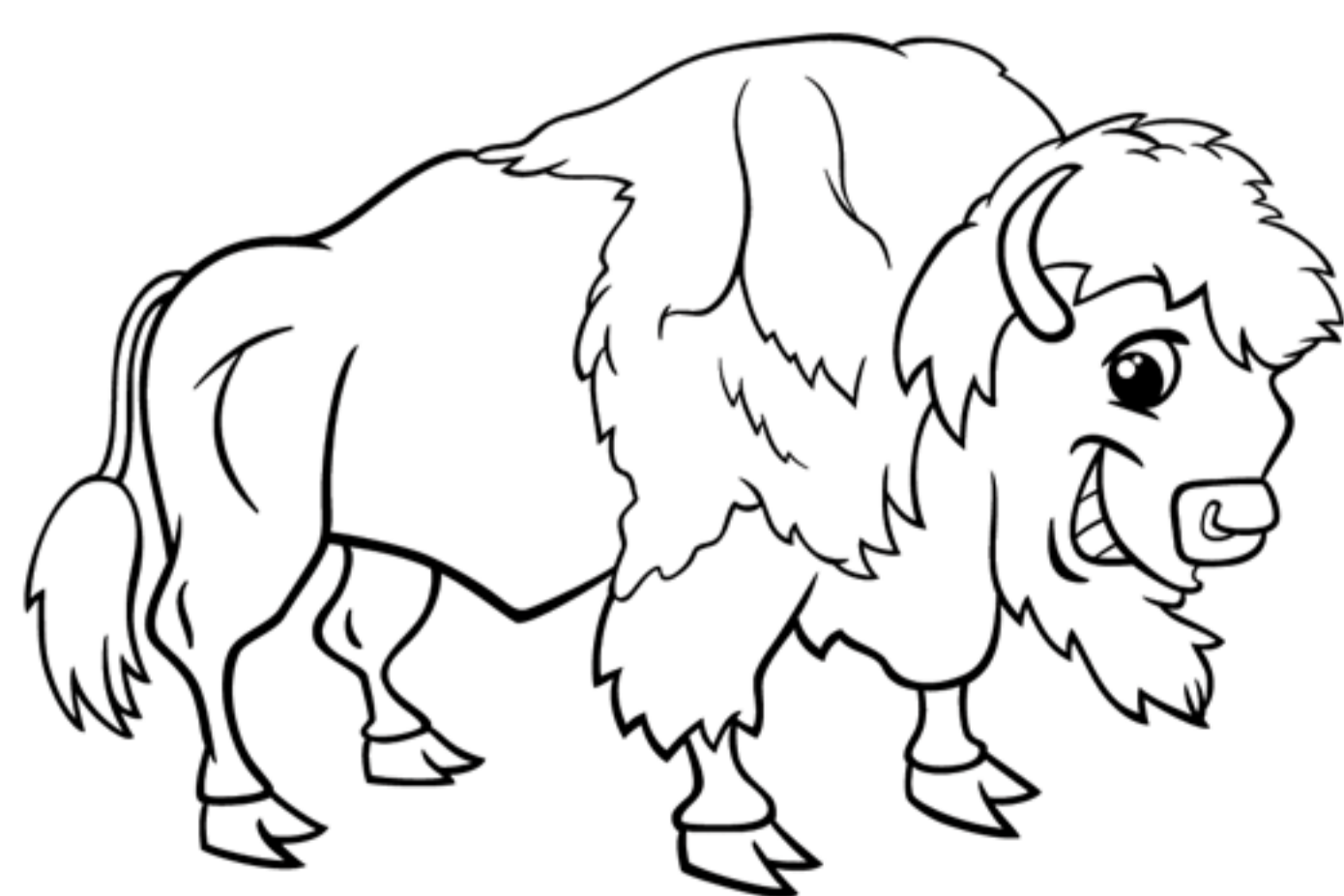

bi ... onte

... aino

cal ... ini

Suoni simili: S-Z

- Completa le frasi con le parole raffigurate.

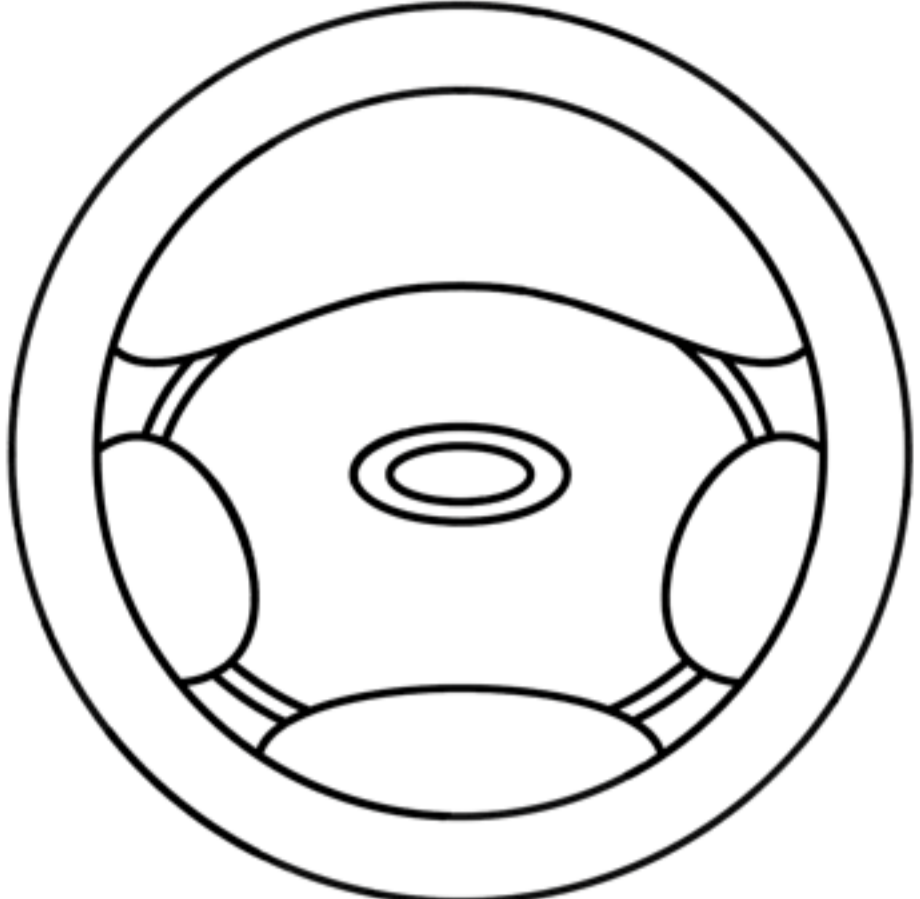
- L'auto di mio padre ha lo  rivestito in pelle.

- La  è una creatura leggendaria acquatica.

Questa è una copia
dimostrativa.

Tutti i nostri eBook possono
essere acquistati sul sito.

©Pianetabambini.it

- Fabio ha regalato una bellissima  a sua moglie.

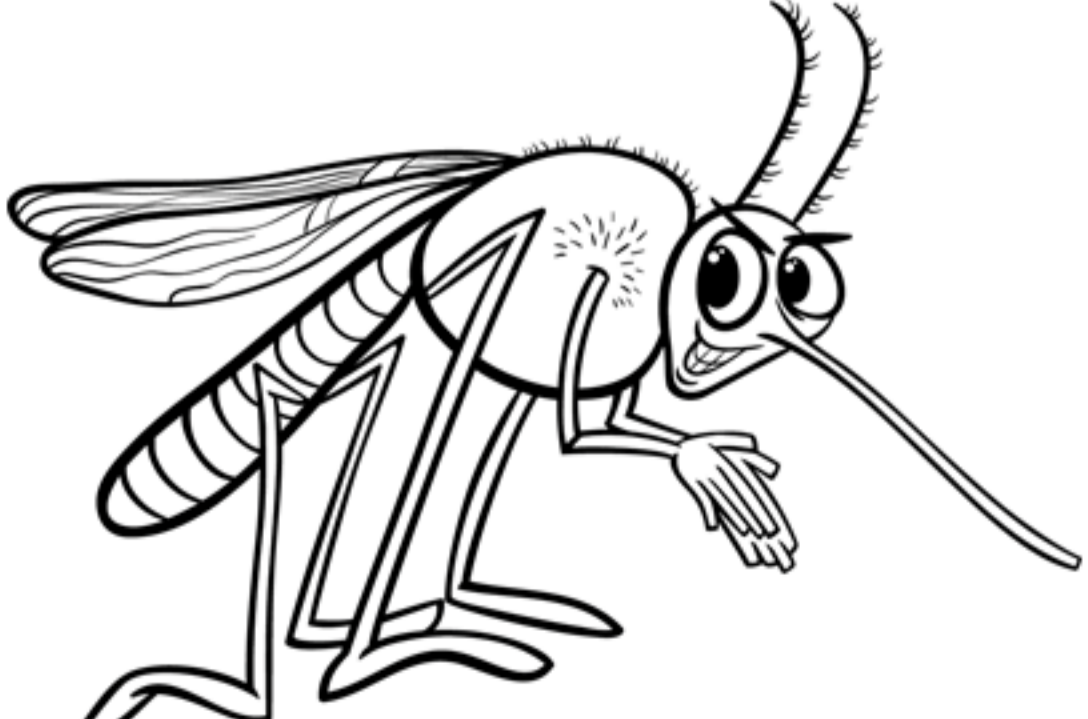
- La  è l'insetto più odiato al mondo.

CA - CO - CU

- Completa le parole con CA, CO, CU.

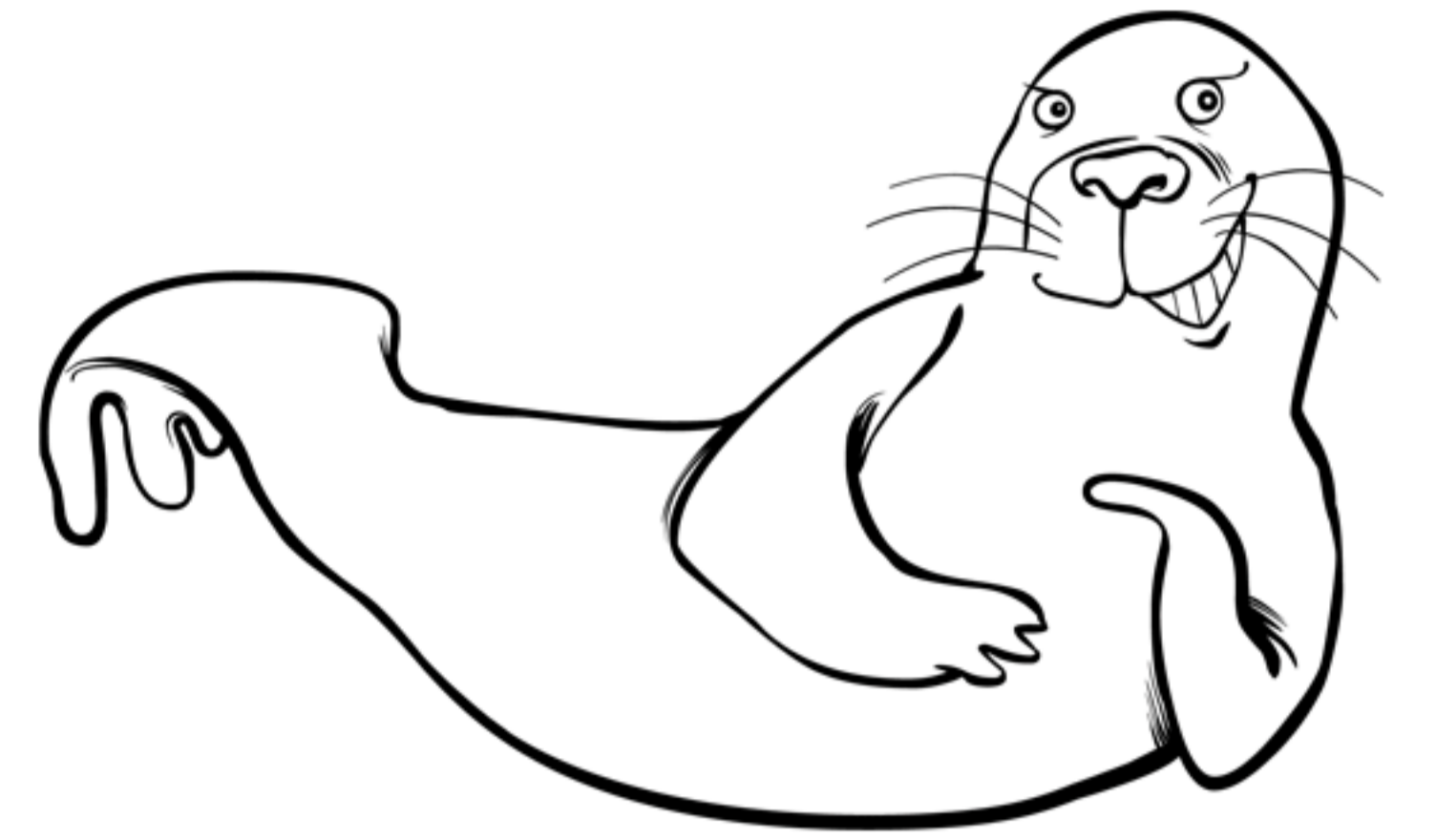
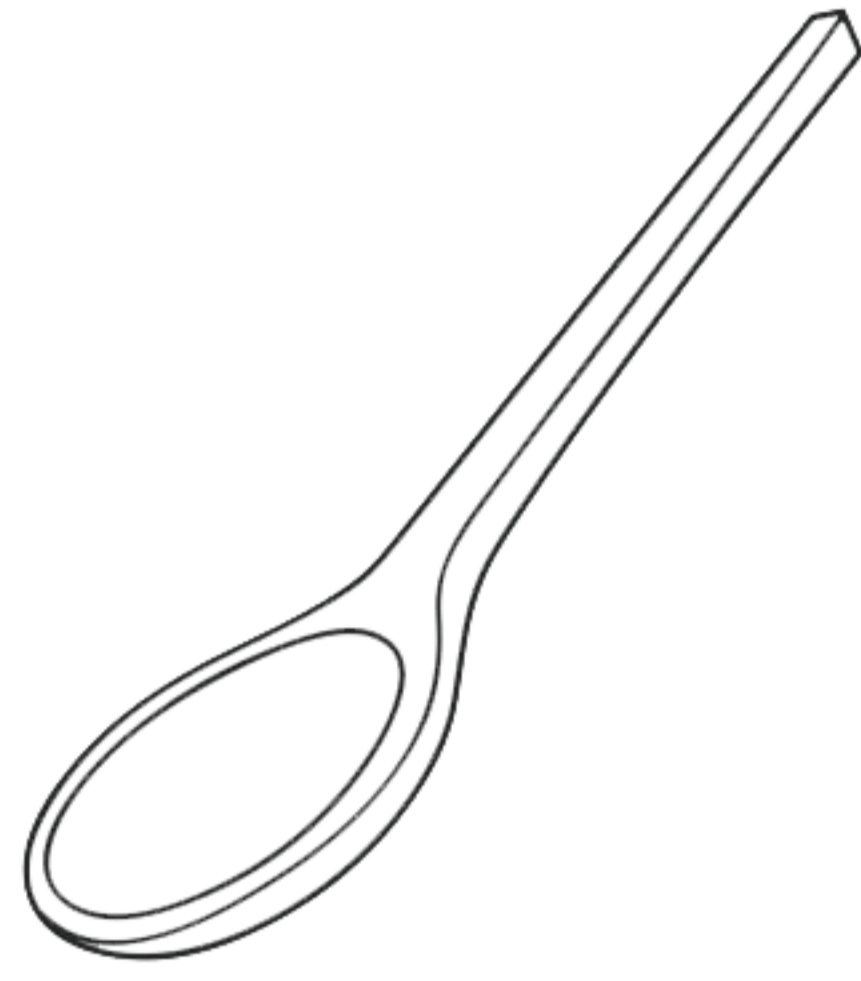
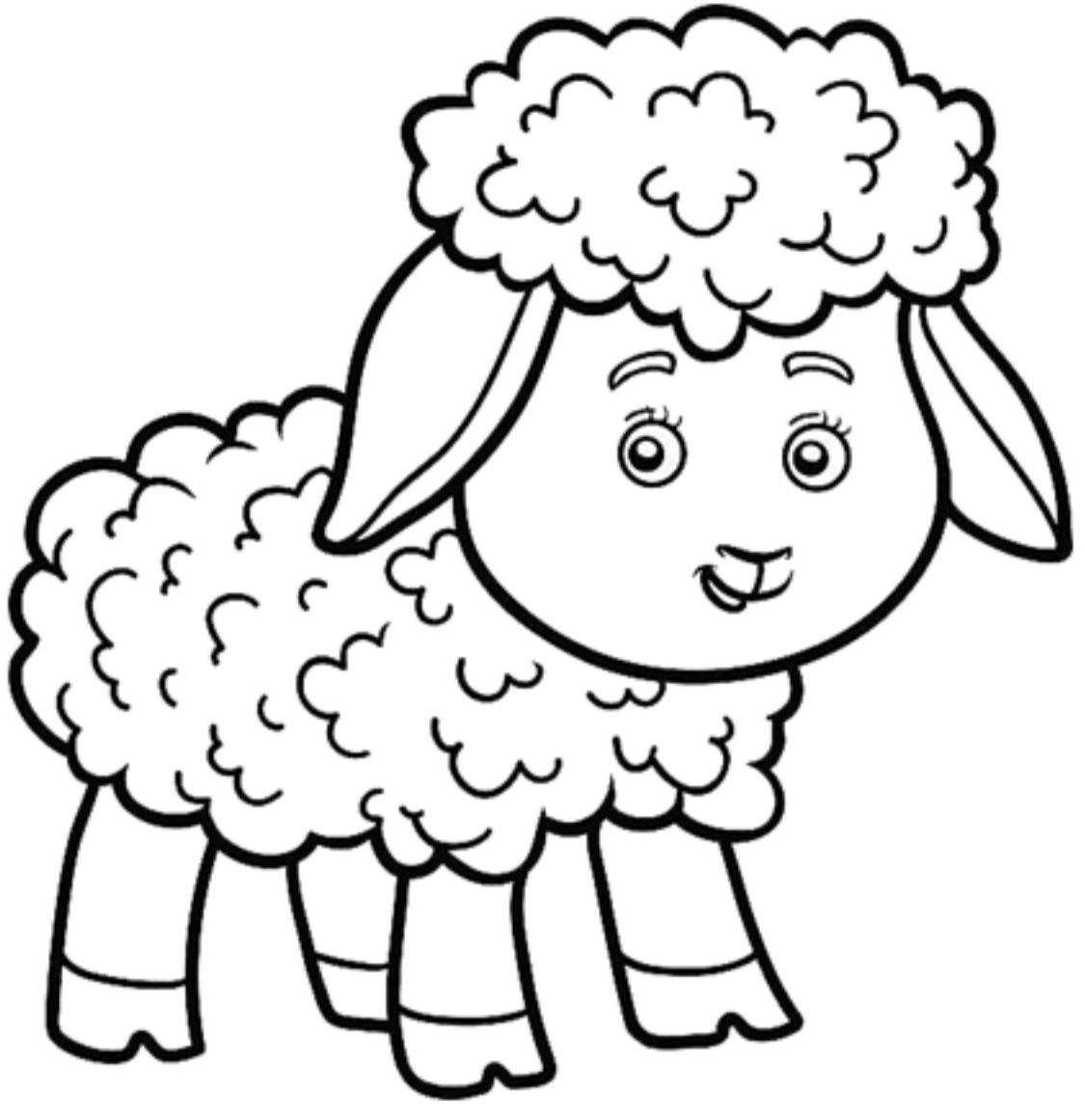

Questa è una copia
dimostrativa.

Tutti i nostri eBook possono
essere acquistati sul sito.

©Pianetabambini.it

...mmello

in ...dine

bru ...

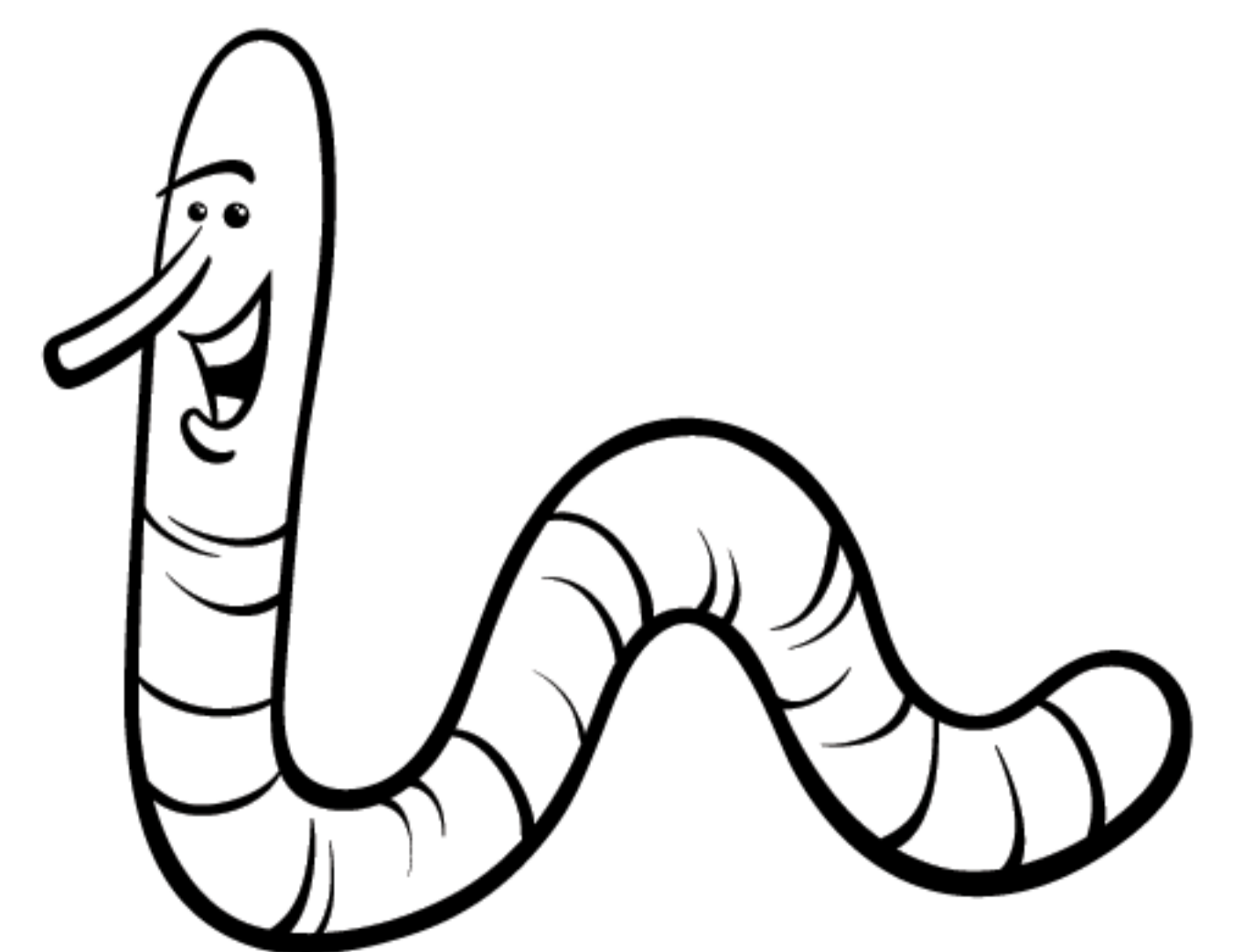
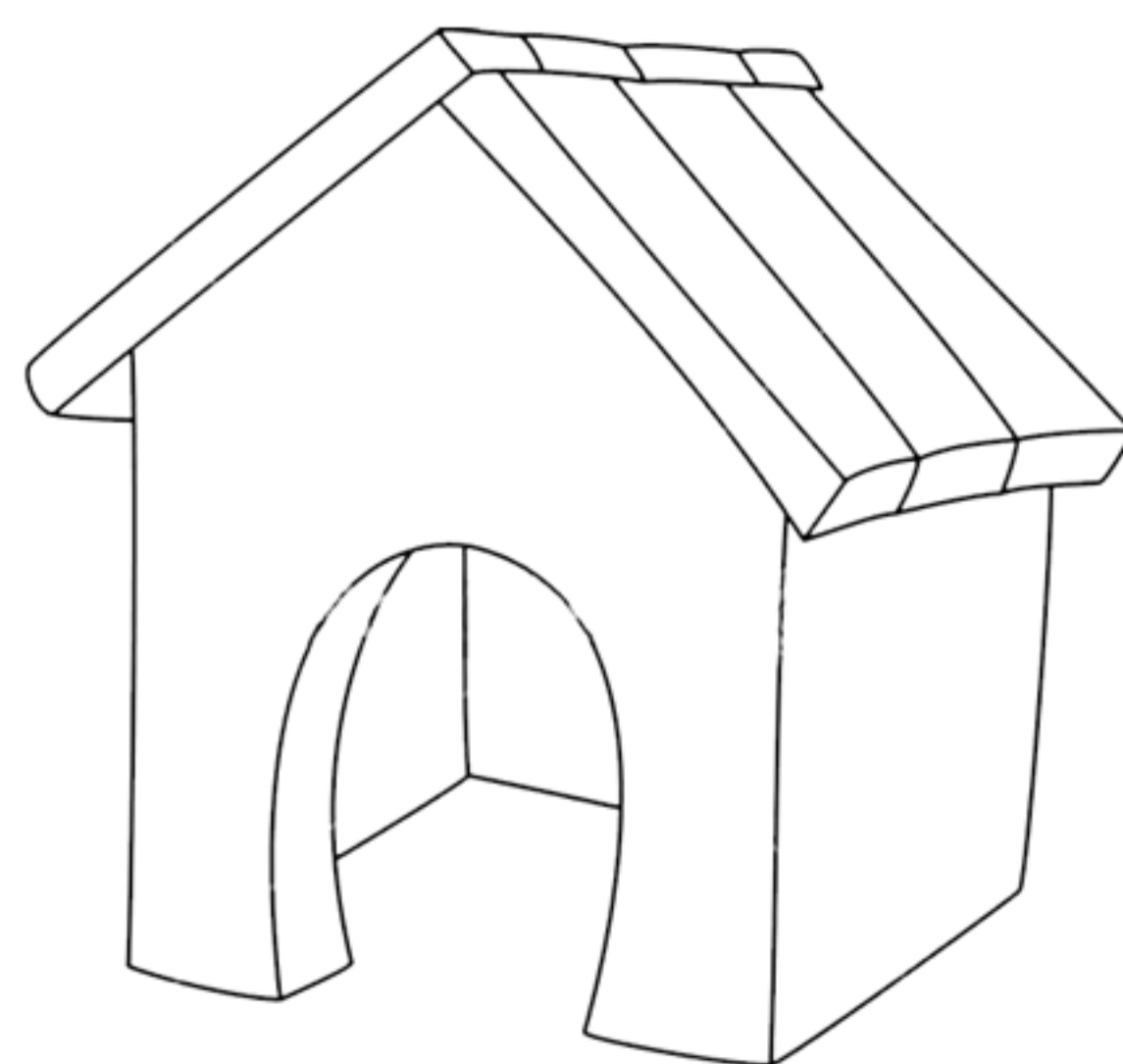

...nguro

...ccia

lombri ...

GA - GO - GU

- Completa le parole con GA, GO, GU.

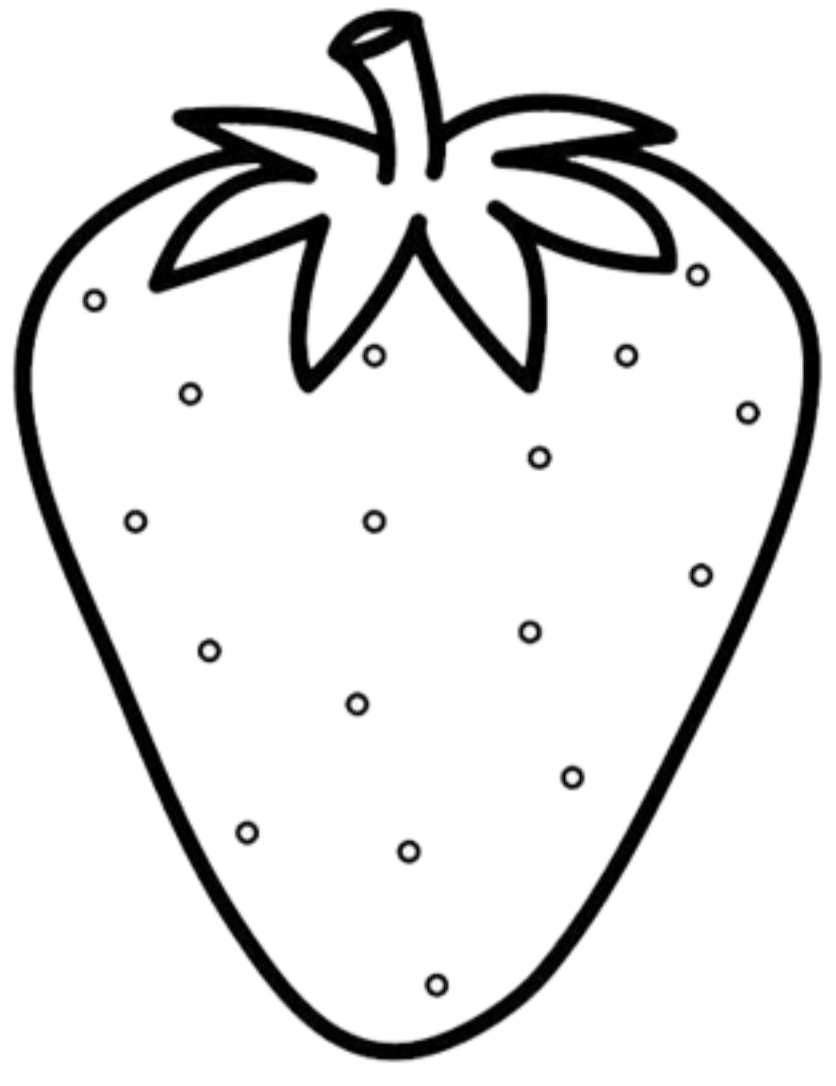

fra ... la

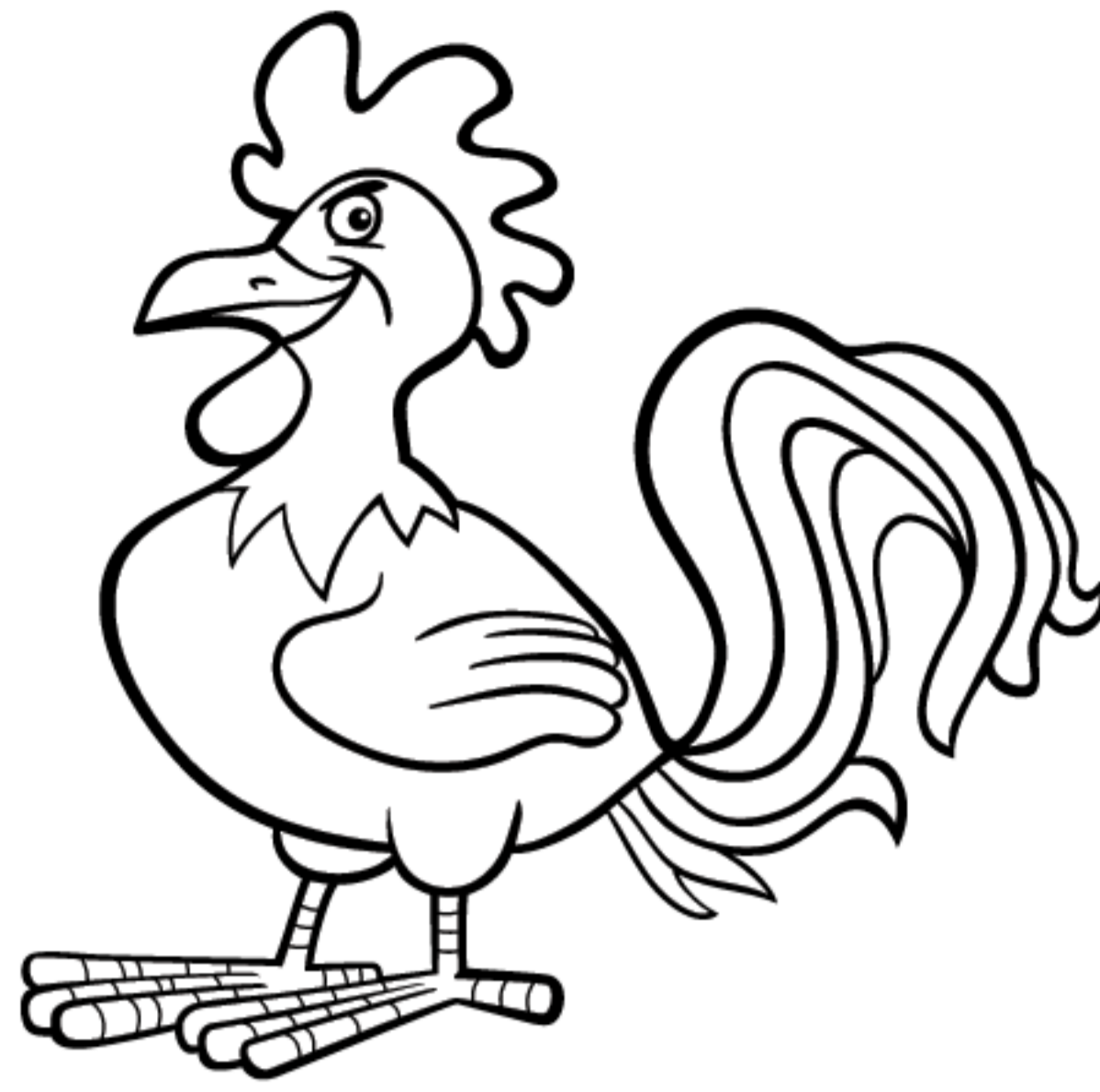

lla

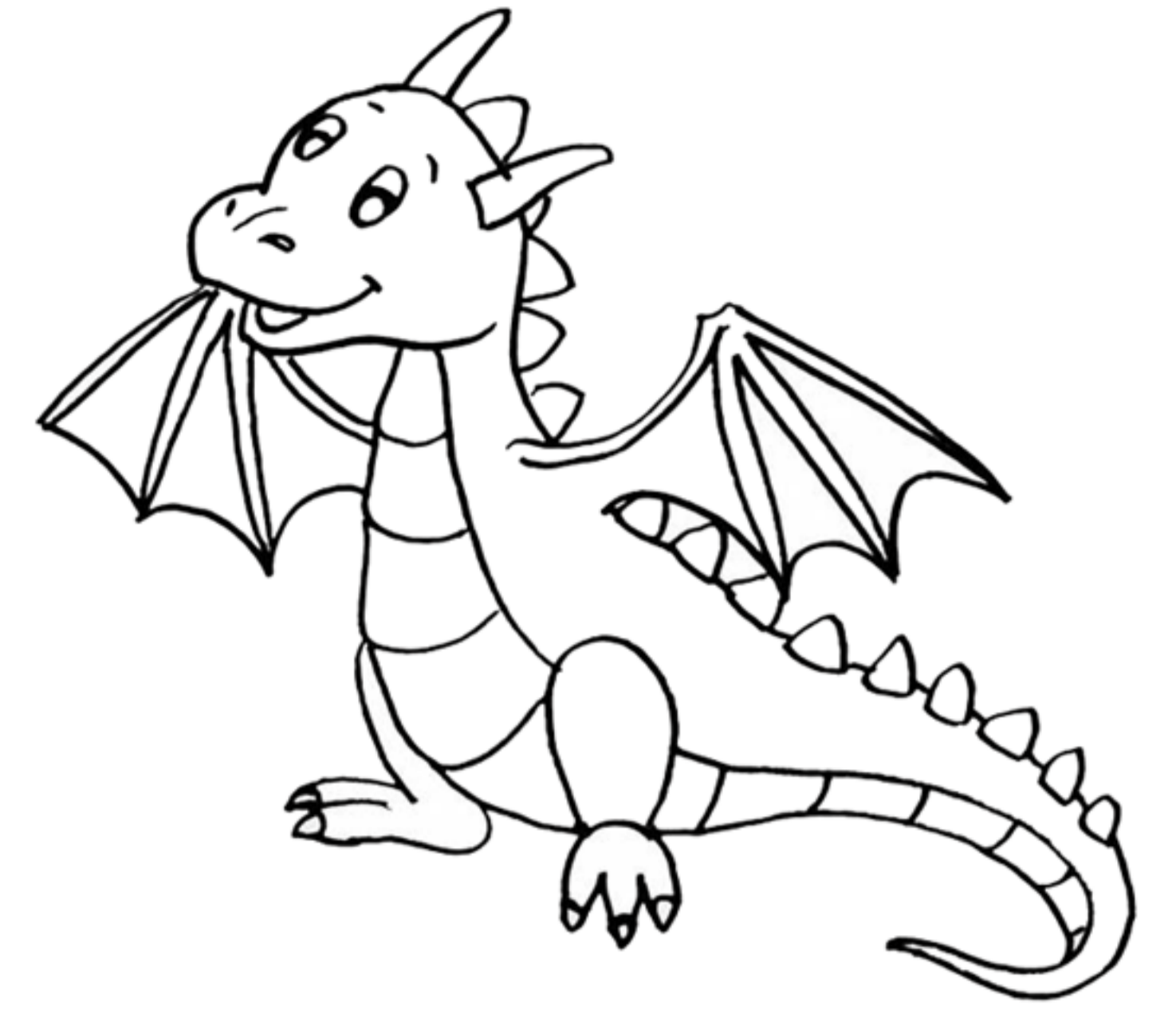

dra

Questa è una copia
dimostrativa.

Tutti i nostri eBook possono
essere acquistati sul sito.

©Pianetabambini.it

can ... ro

tartaru ...

... rilla

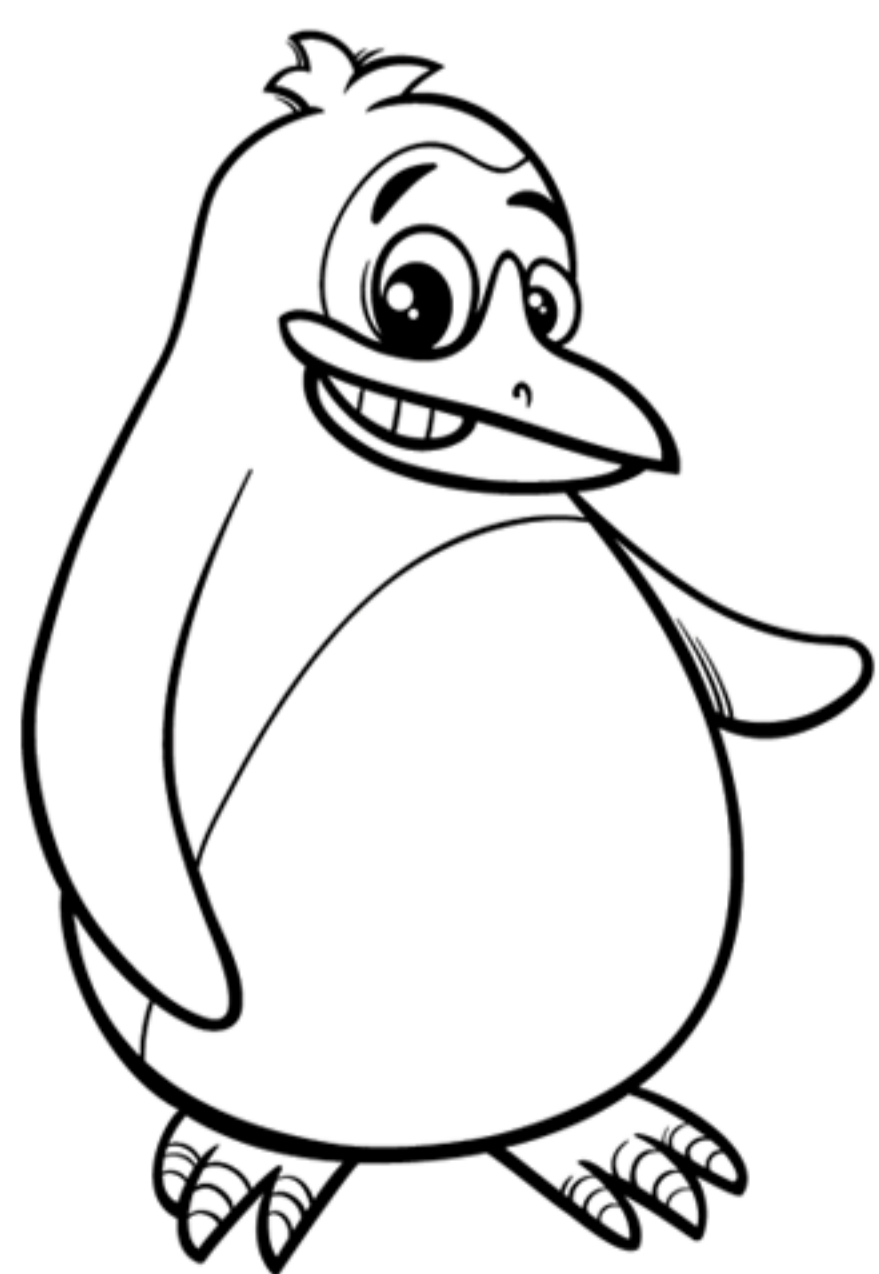

pin ... ino

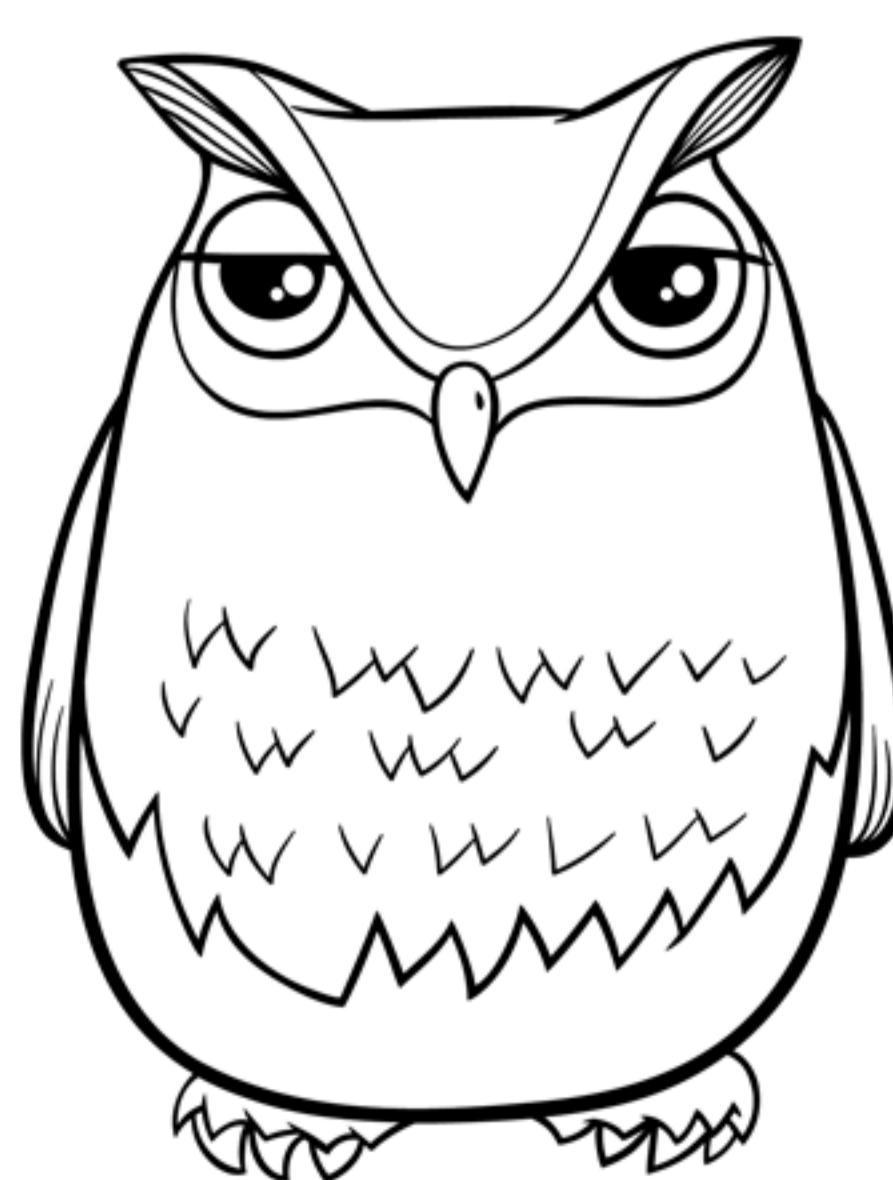

... fo



pappa ... llo

CIA - CIO - CIU

- Completa le parole con CIA, CIO, CIU.

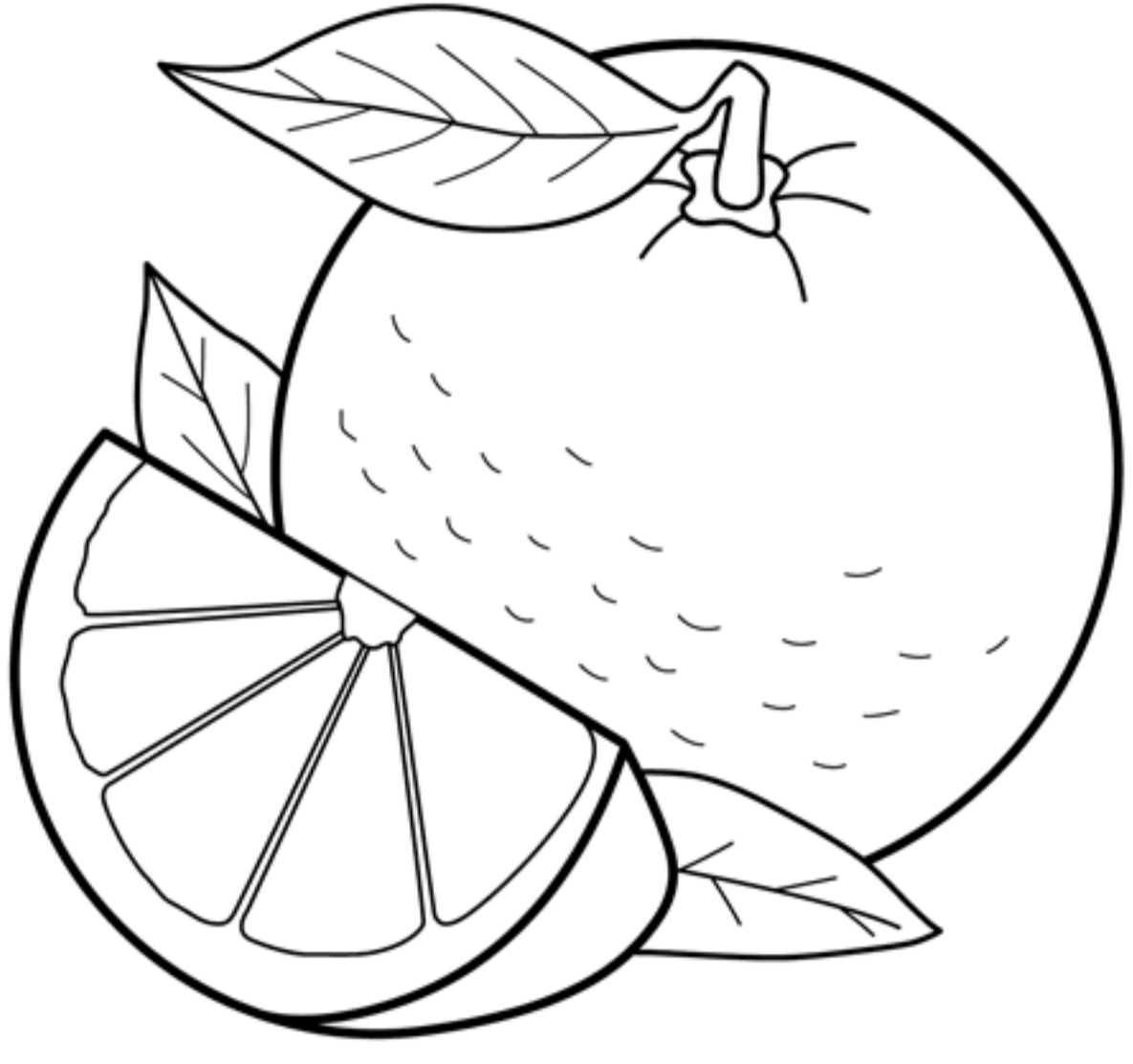

aranc

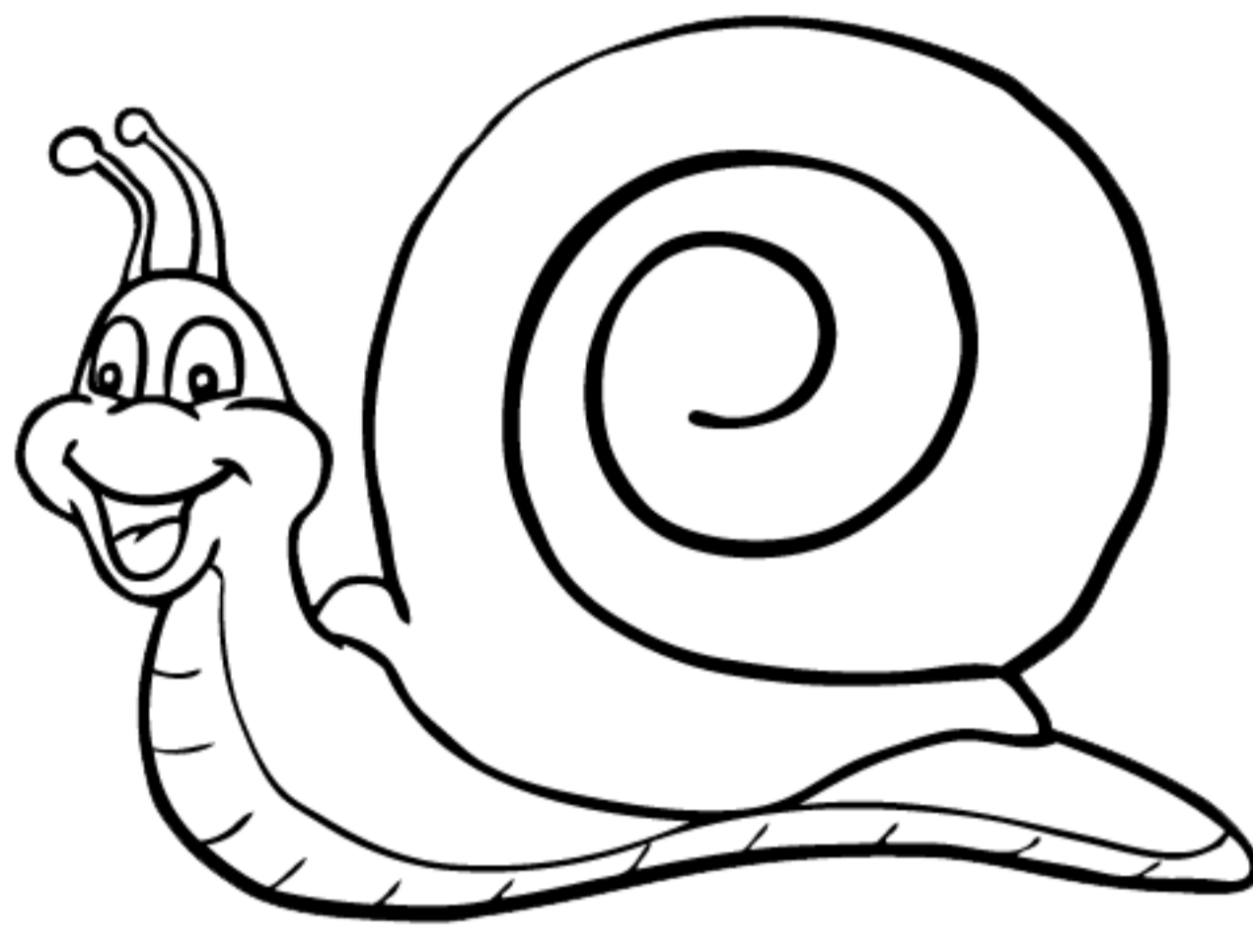

chioc



delici

Questa è una copia
dimostrativa.

Tutti i nostri eBook possono
essere acquistati sul sito.

©Pianetabambini.it

ba

quer

ac ga



.... rma



.... batte

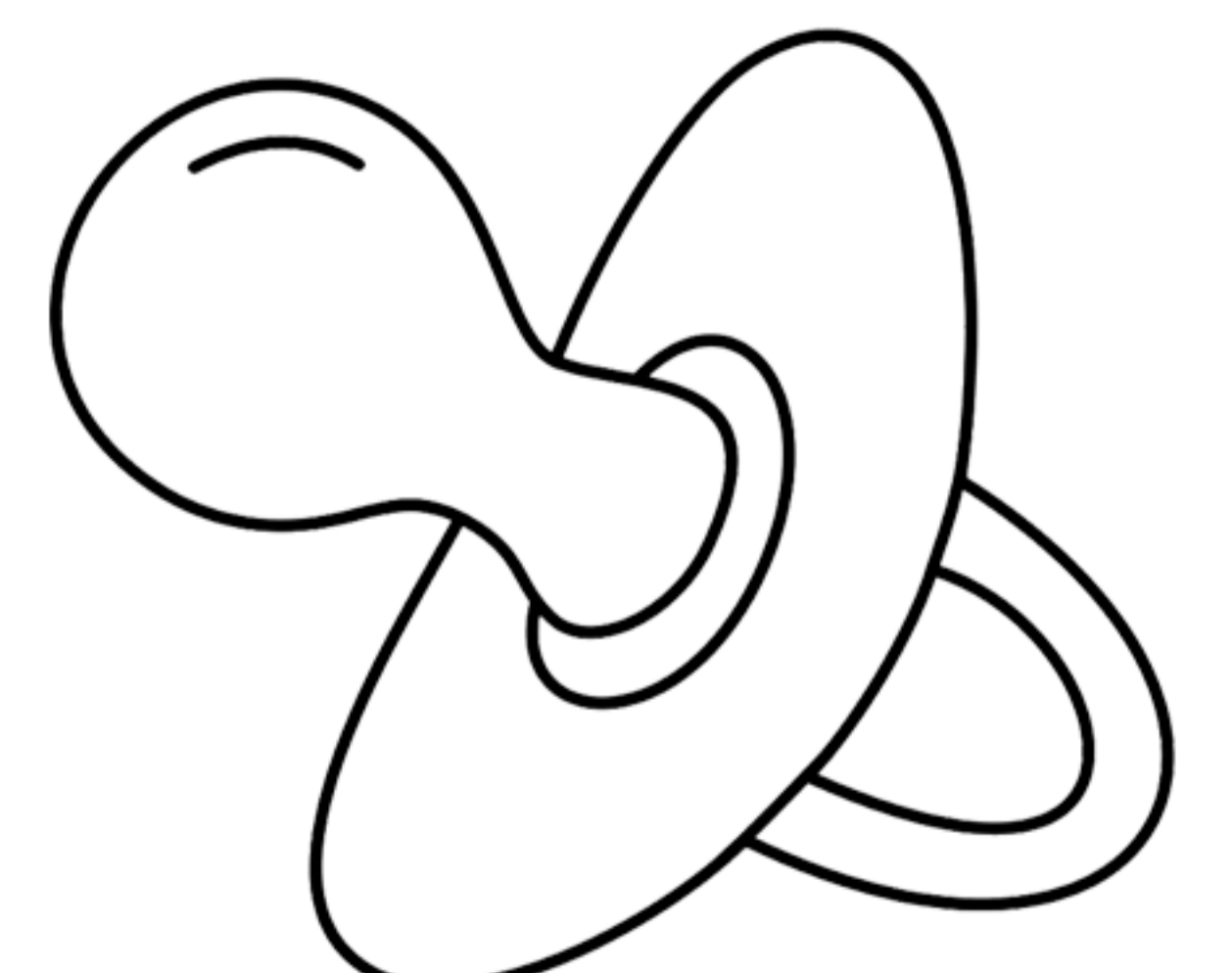

.... C

GIA - GIO - GIU

- Completa le parole con GIA, GIO, GIU.

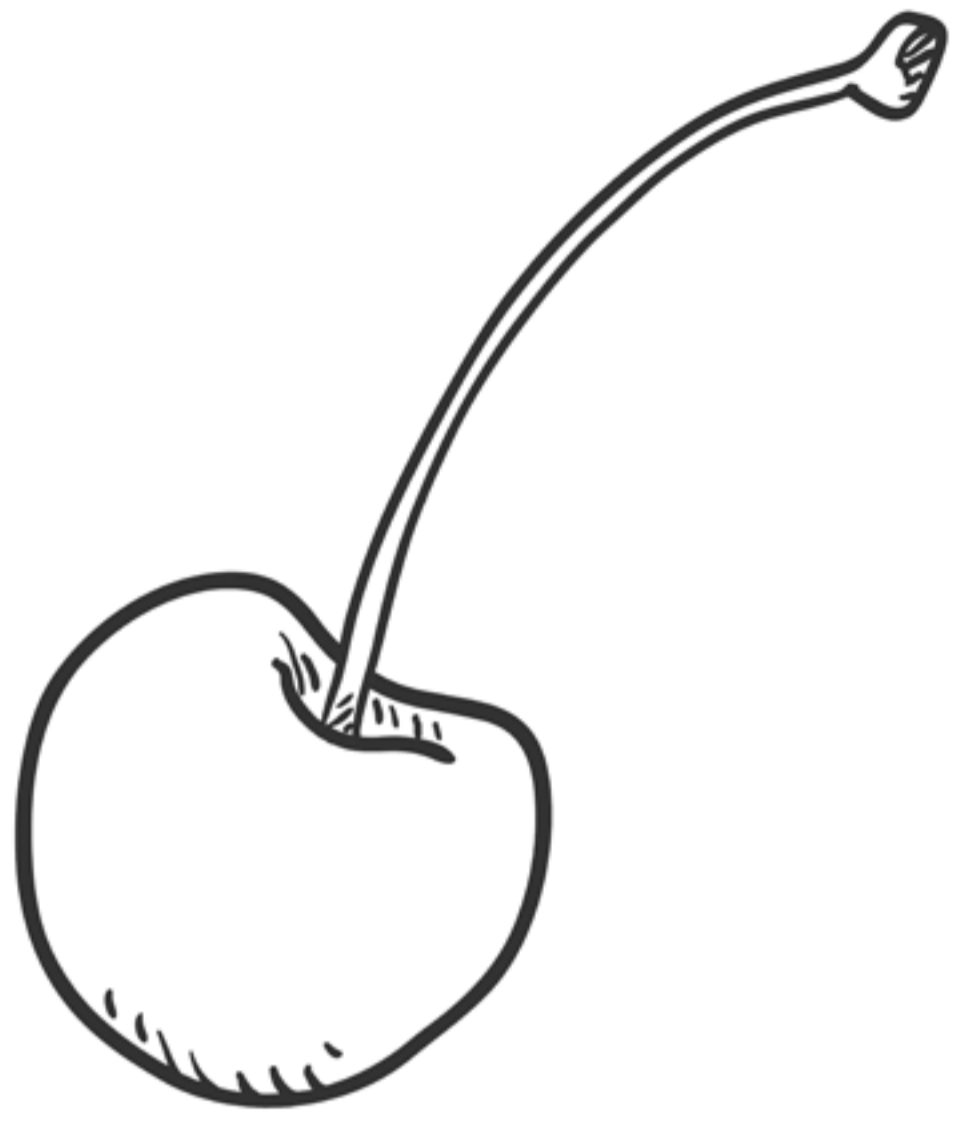

... ille



... pri ... no

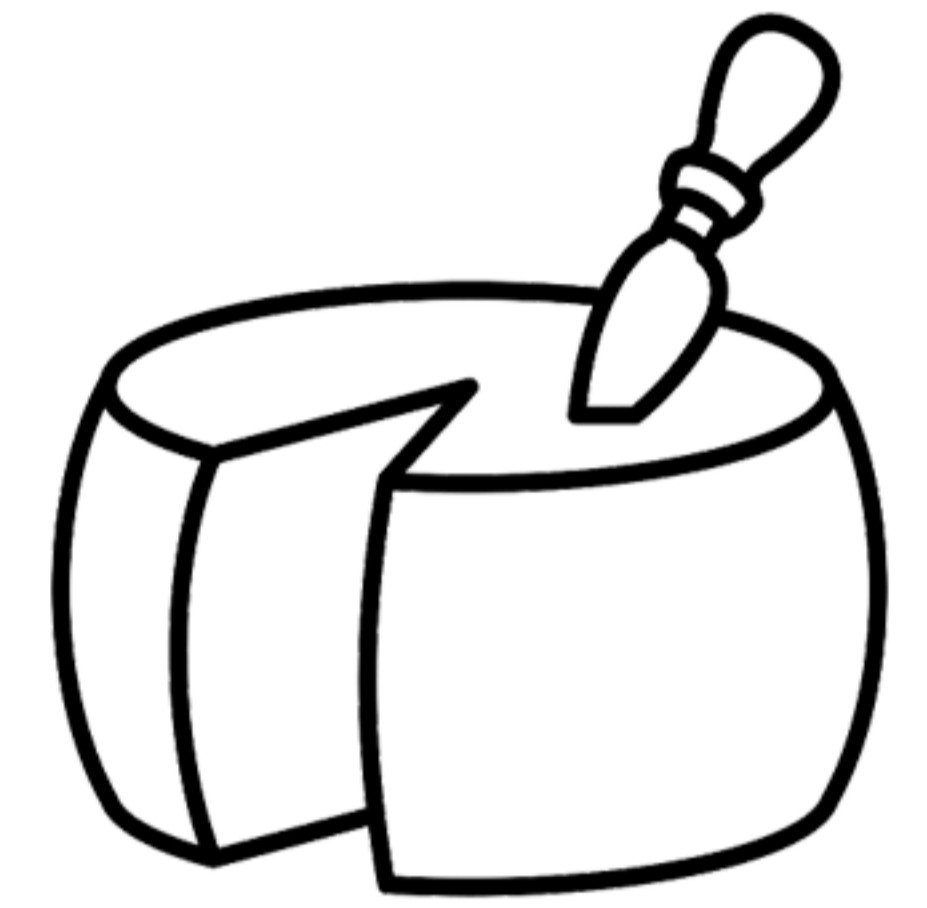

... curpi ... no

Questa è una copia
dimostrativa.

Tutti i nostri eBook possono
essere acquistati sul sito.

©Pianetabambini.it

fa no

.... cattoli

.... guaro



.... llare



scarafag



pi ma

CE - CI

- Completa le parole con CE, CI.

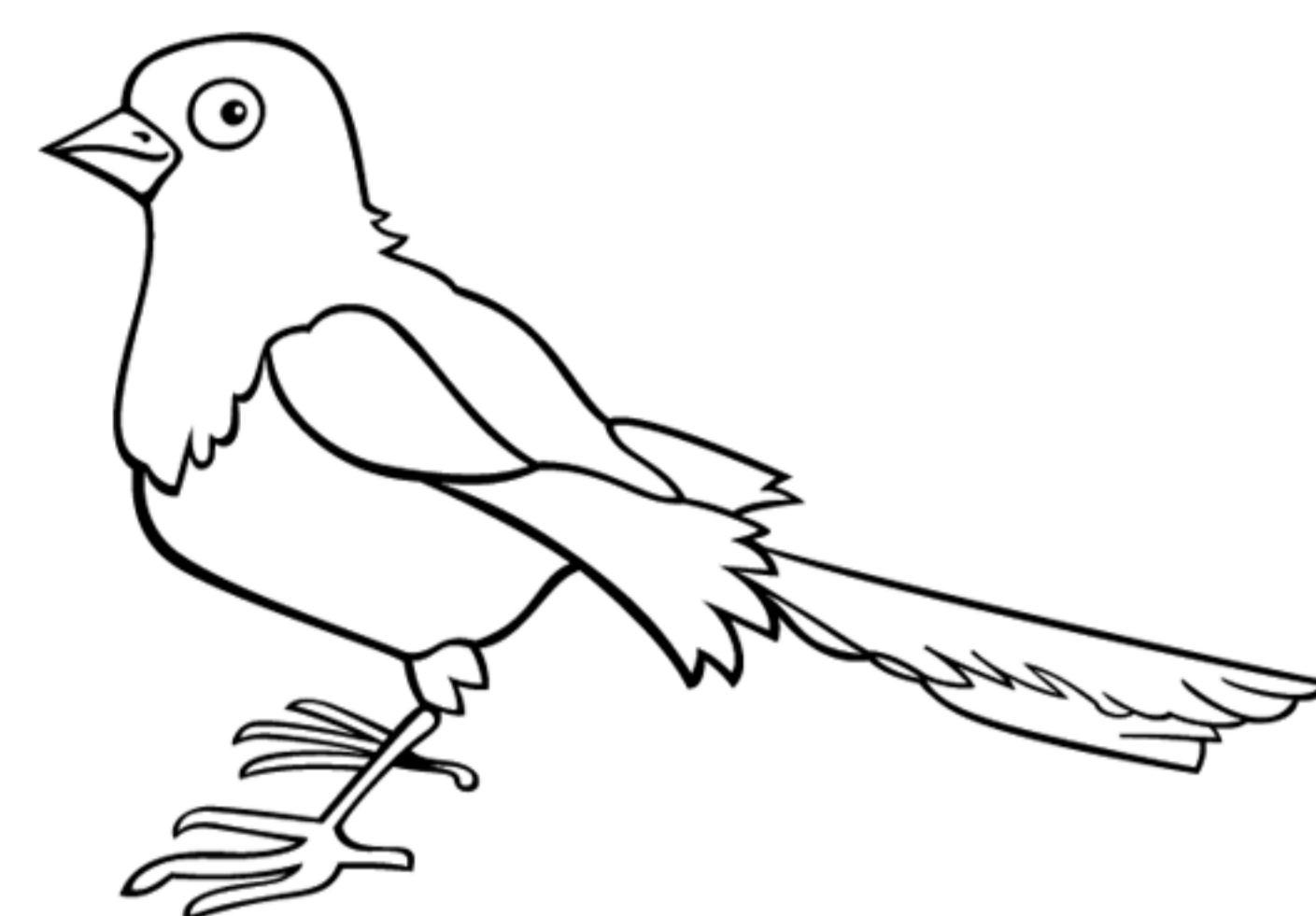
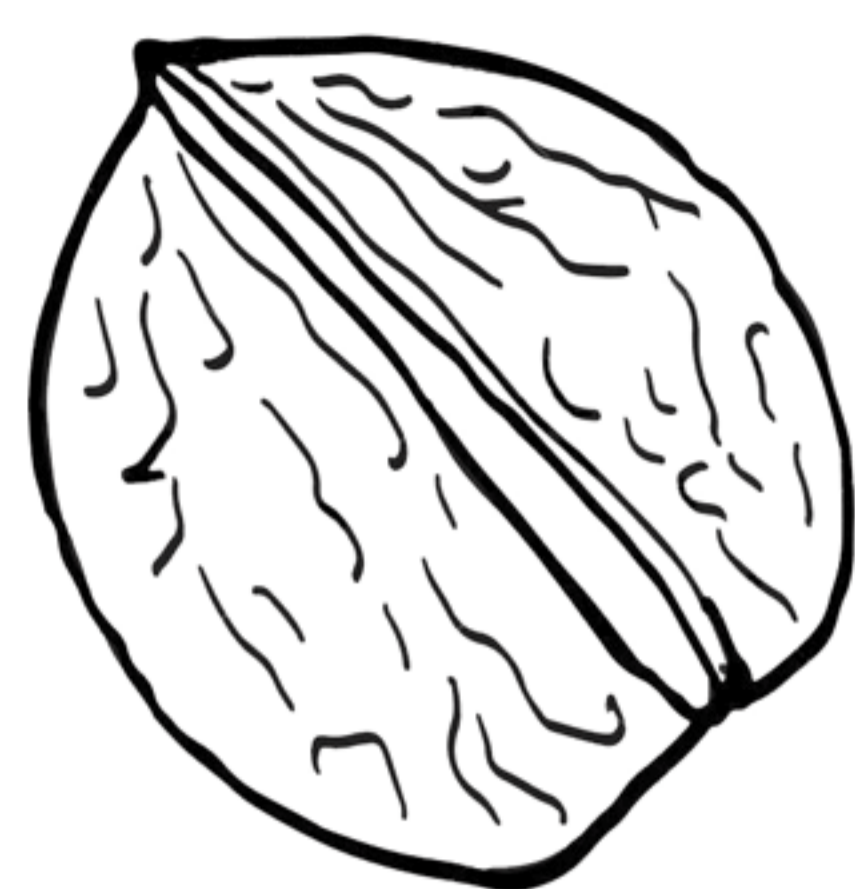

pul ... ce

no ... ci

uo ... ce

Questa è una copia
dimostrativa.

Tutti i nostri eBook possono
essere acquistati sul sito.

©Pianetabambini.it

... rotto

... vetta

... cogna

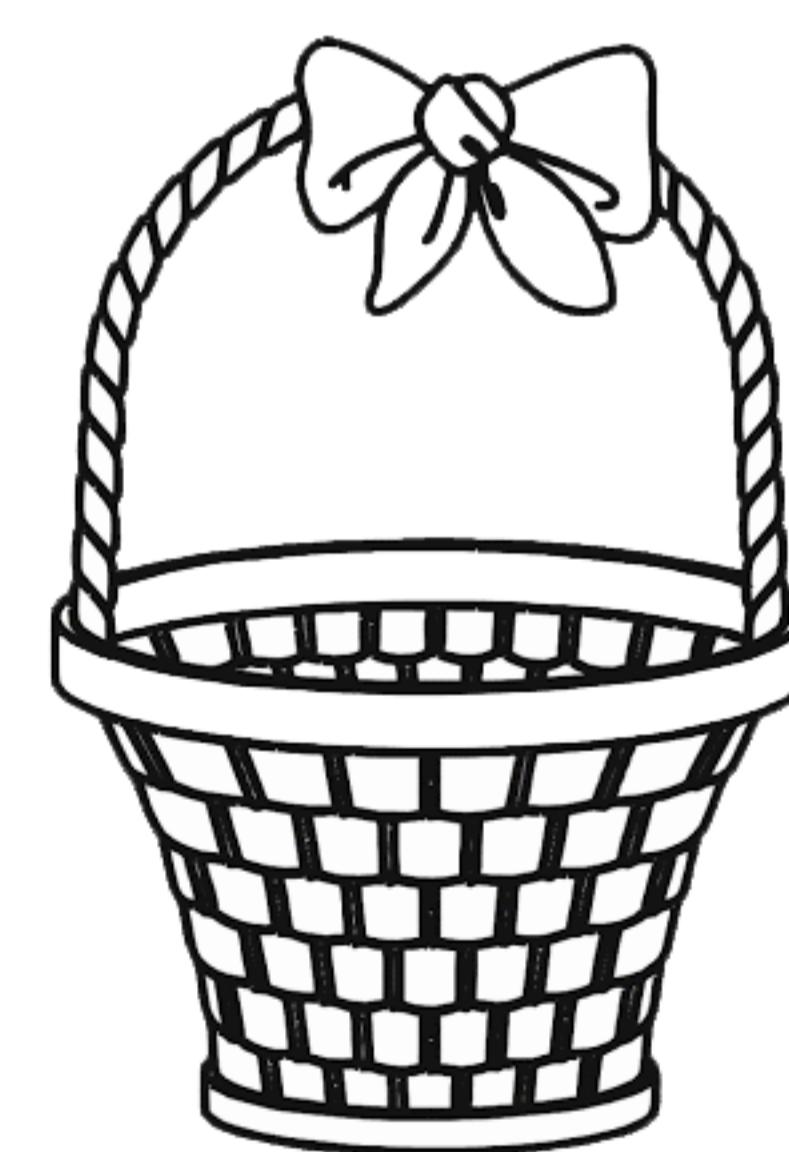
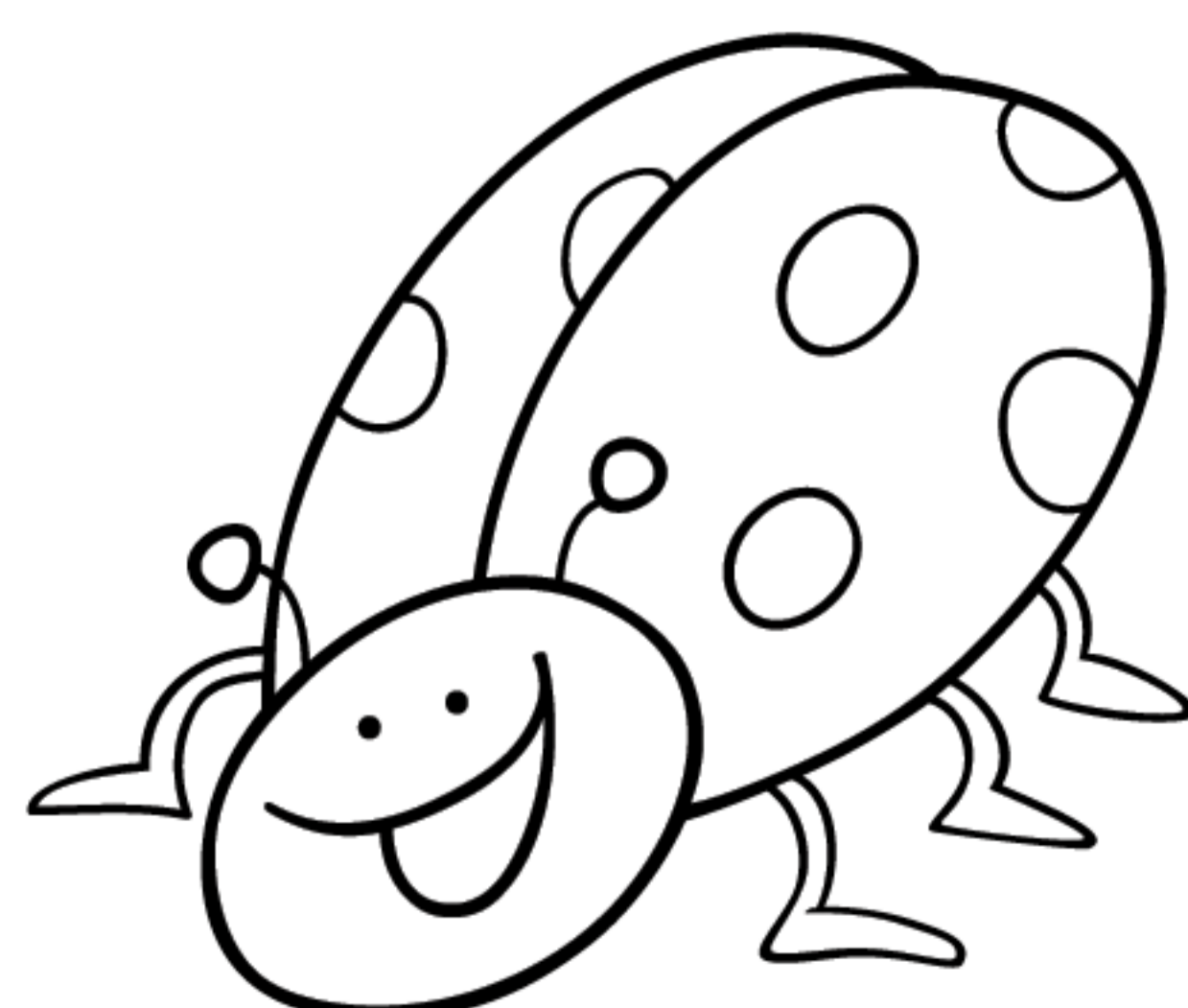
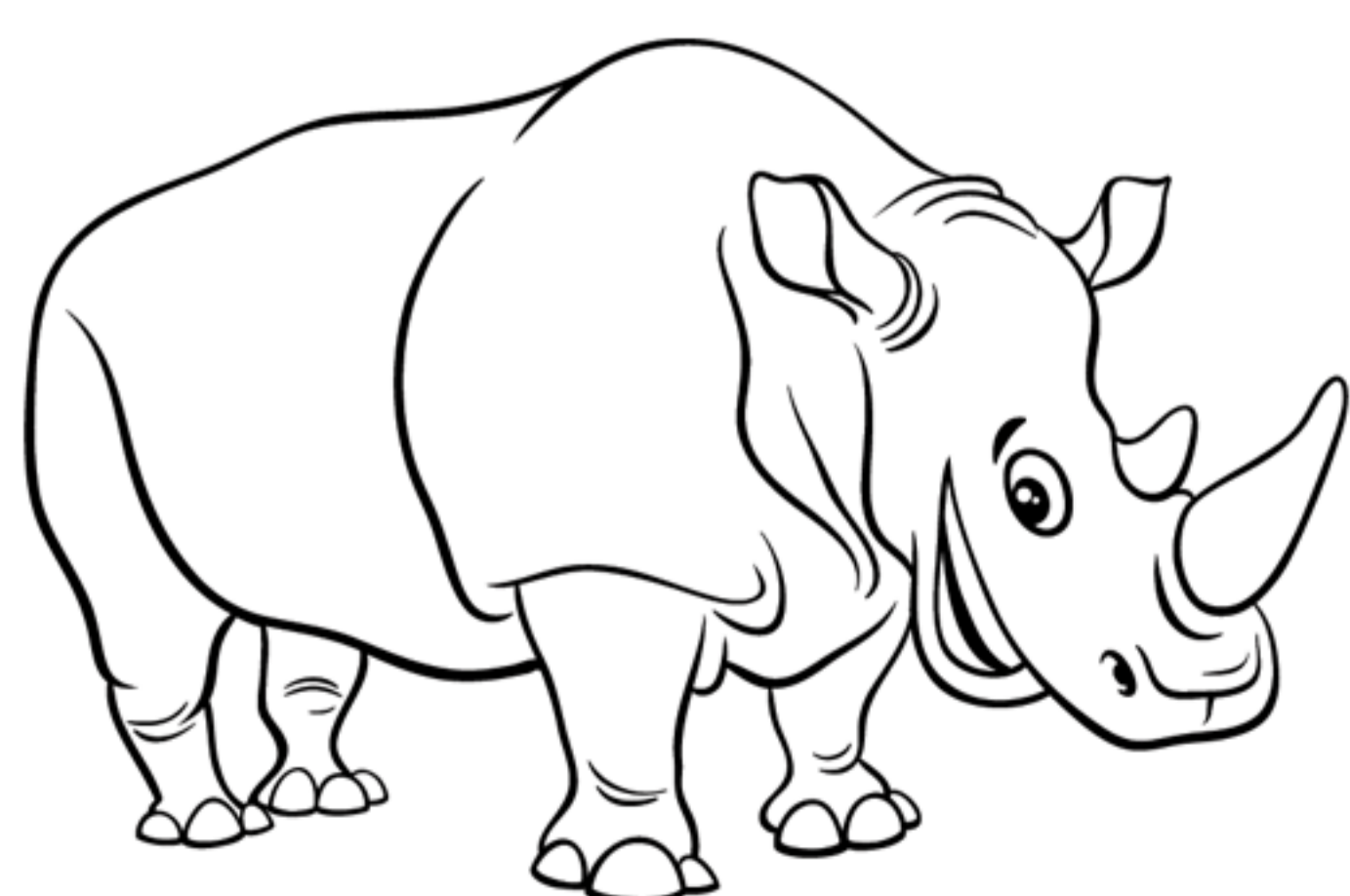

rino ... ronte

coc ... nella

... sto

GE - GI

- Completa le parole con GE, GI.



pu...lo



an...lo

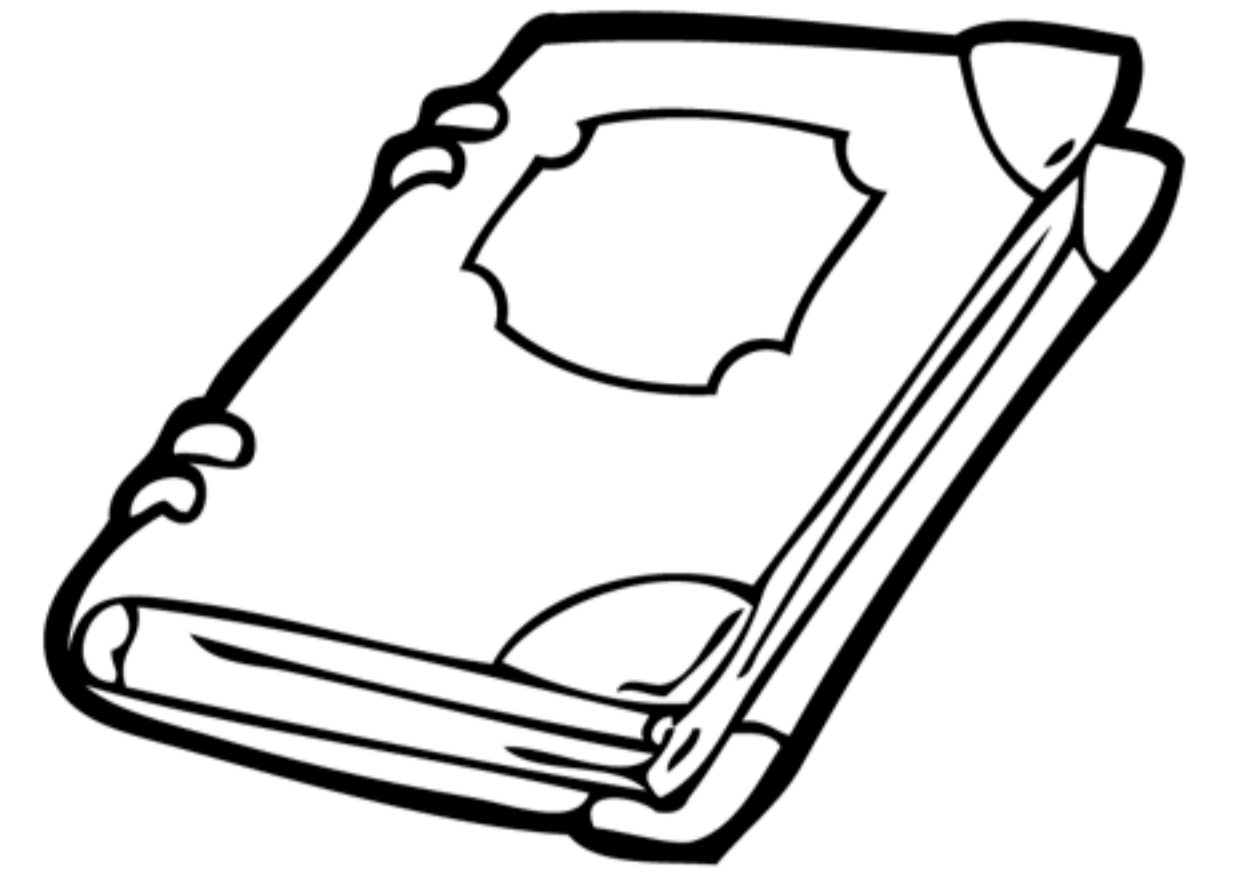

a...nda

Questa è una copia dimostrativa.
Tutti i nostri eBook possono essere acquistati sul sito.
©Pianetabambini.it

...co

...rasole

vi...le

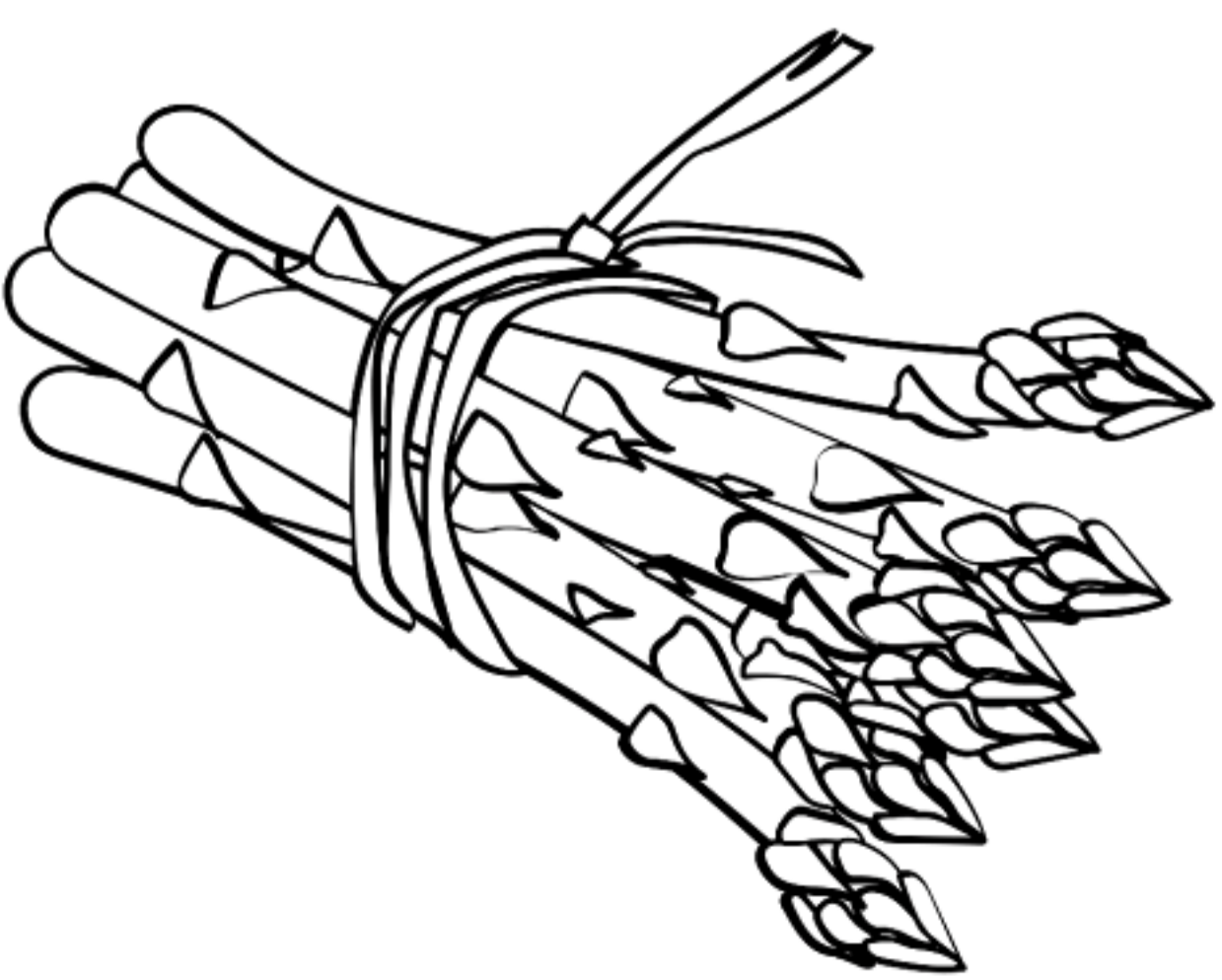

aspara ...

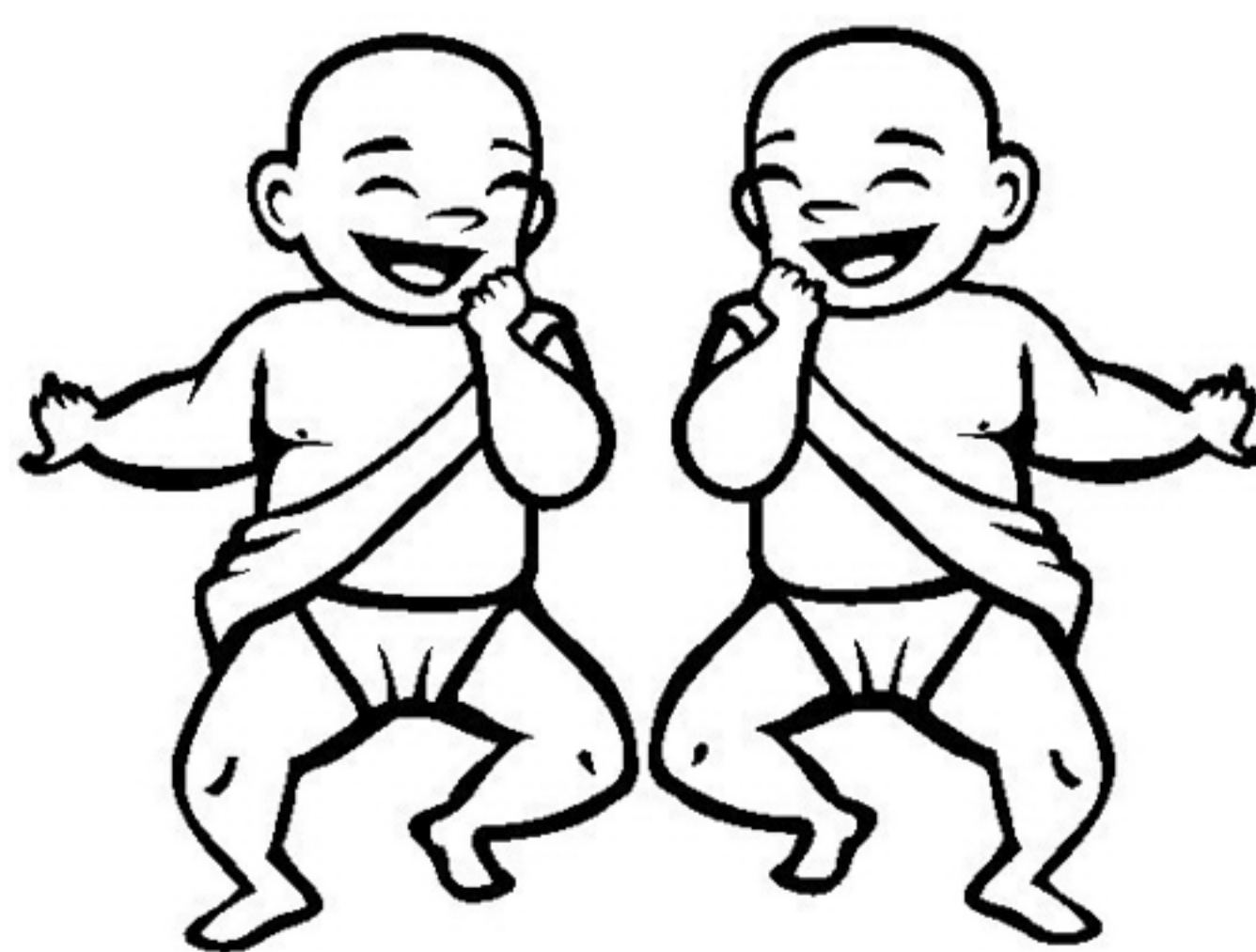

...melli



...ranio

CHE - CHI

- Completa le parole con CHE, CHI.

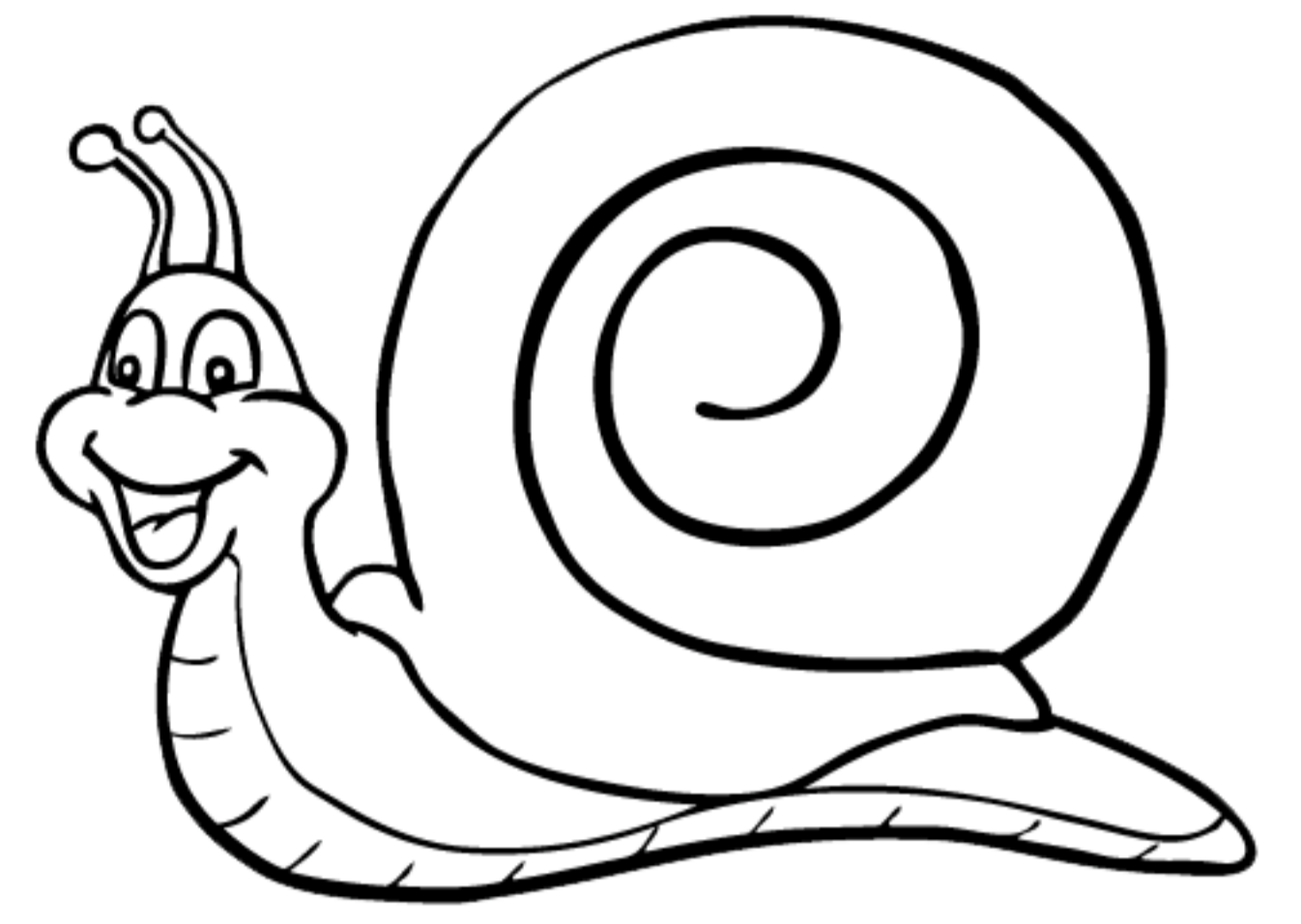
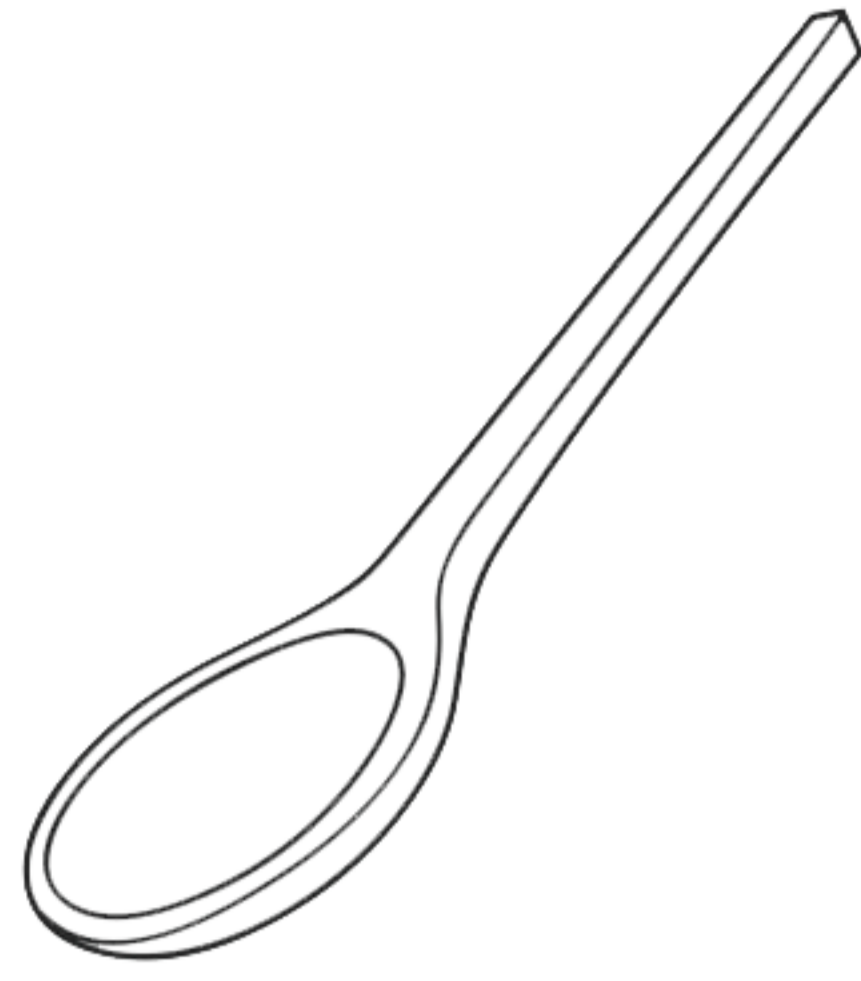
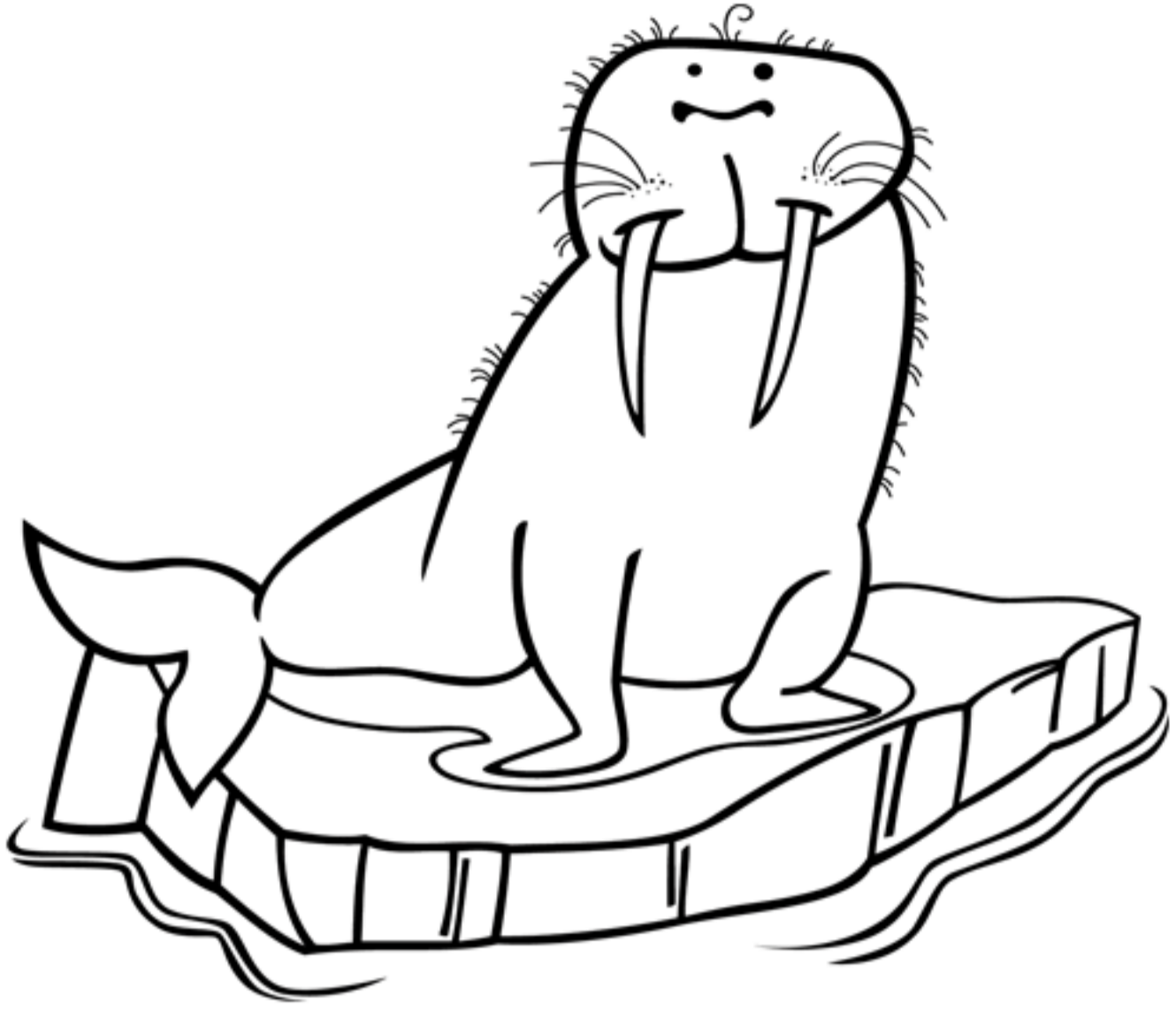

tri

co

cu

cia

cciola

Questa è una copia
dimostrativa.

Tutti i nostri eBook possono
essere acquistati sul sito.

©Pianetabambini.it

o

muc

fi

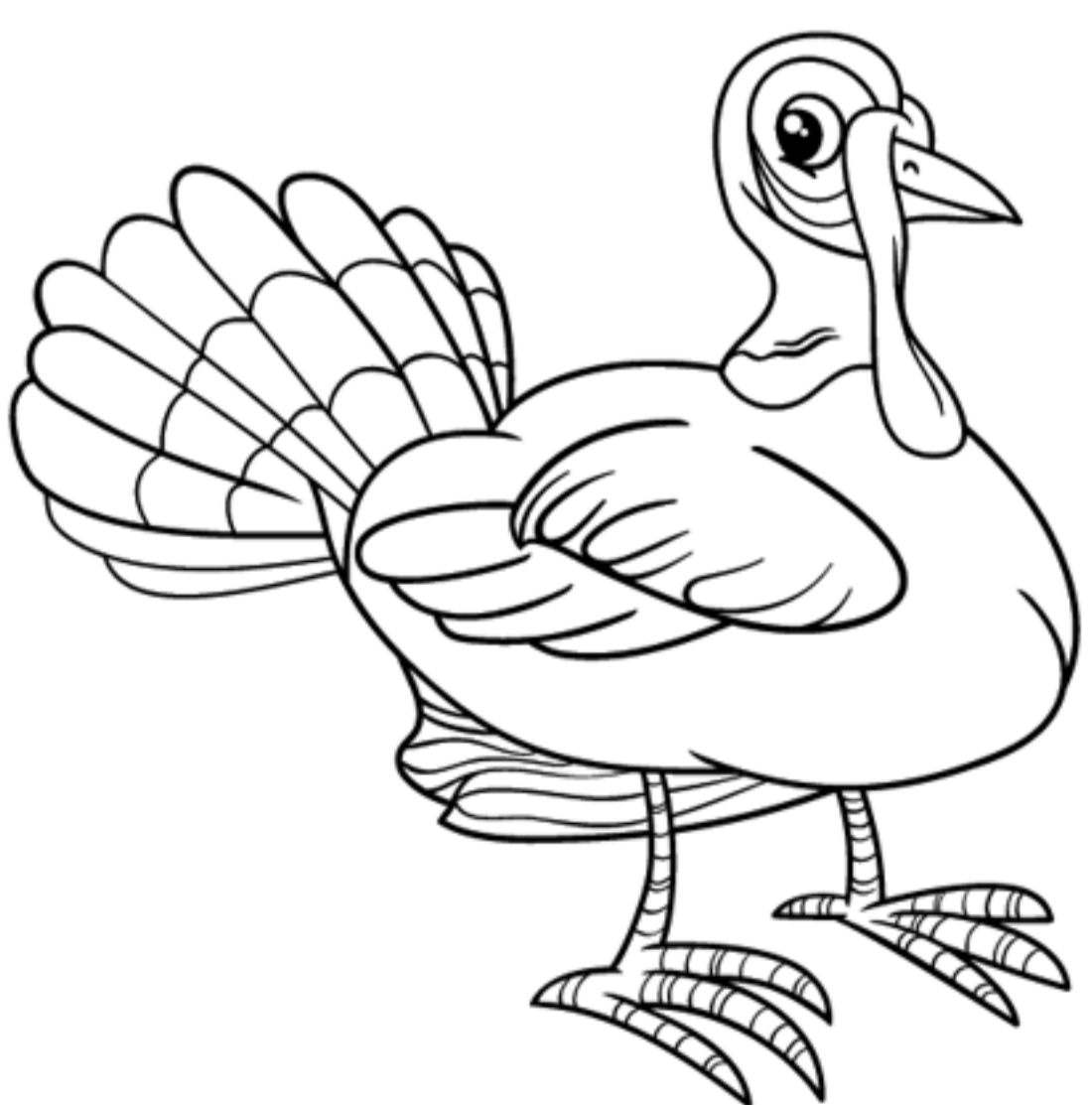

tac no

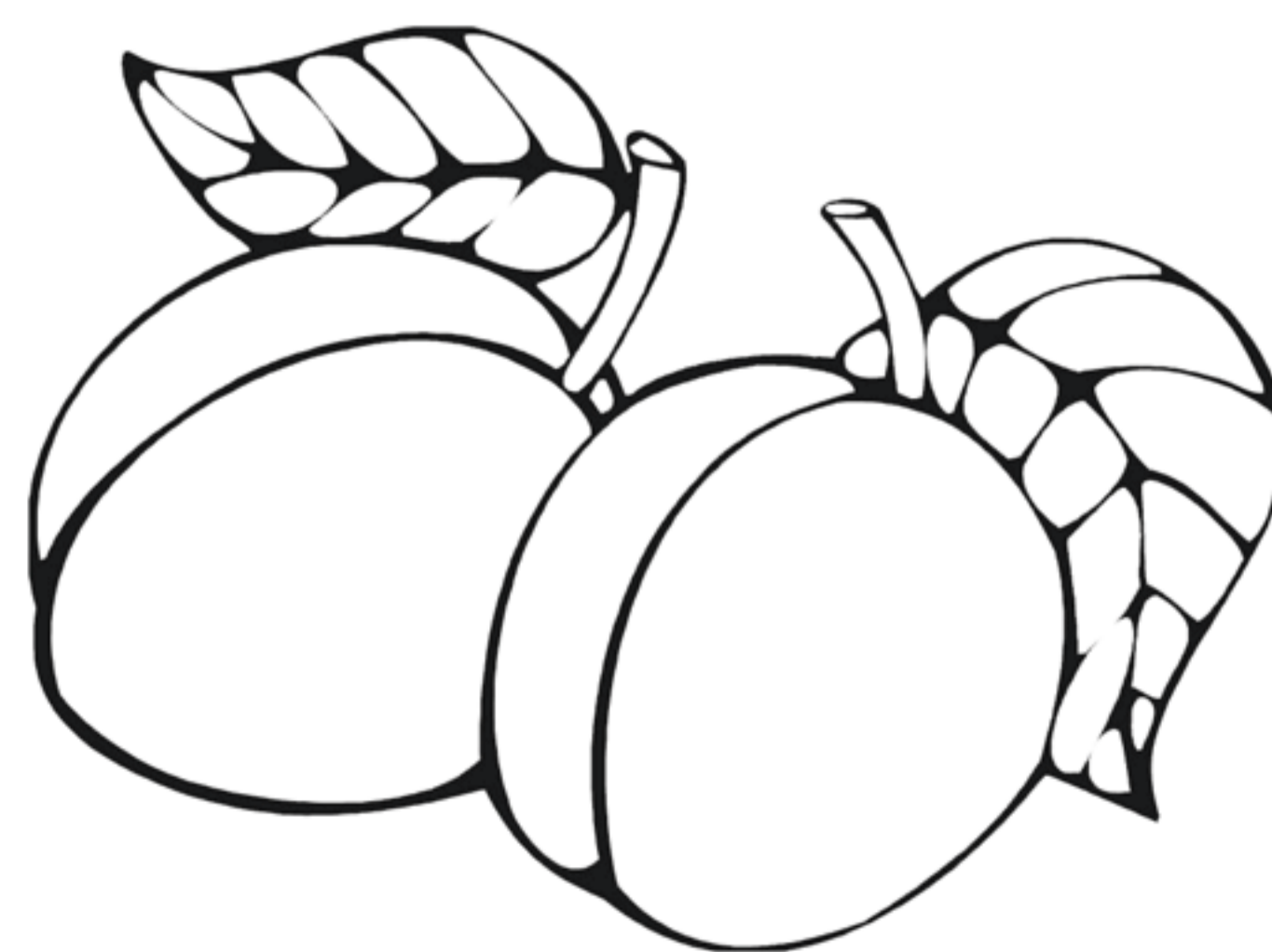

albicoc

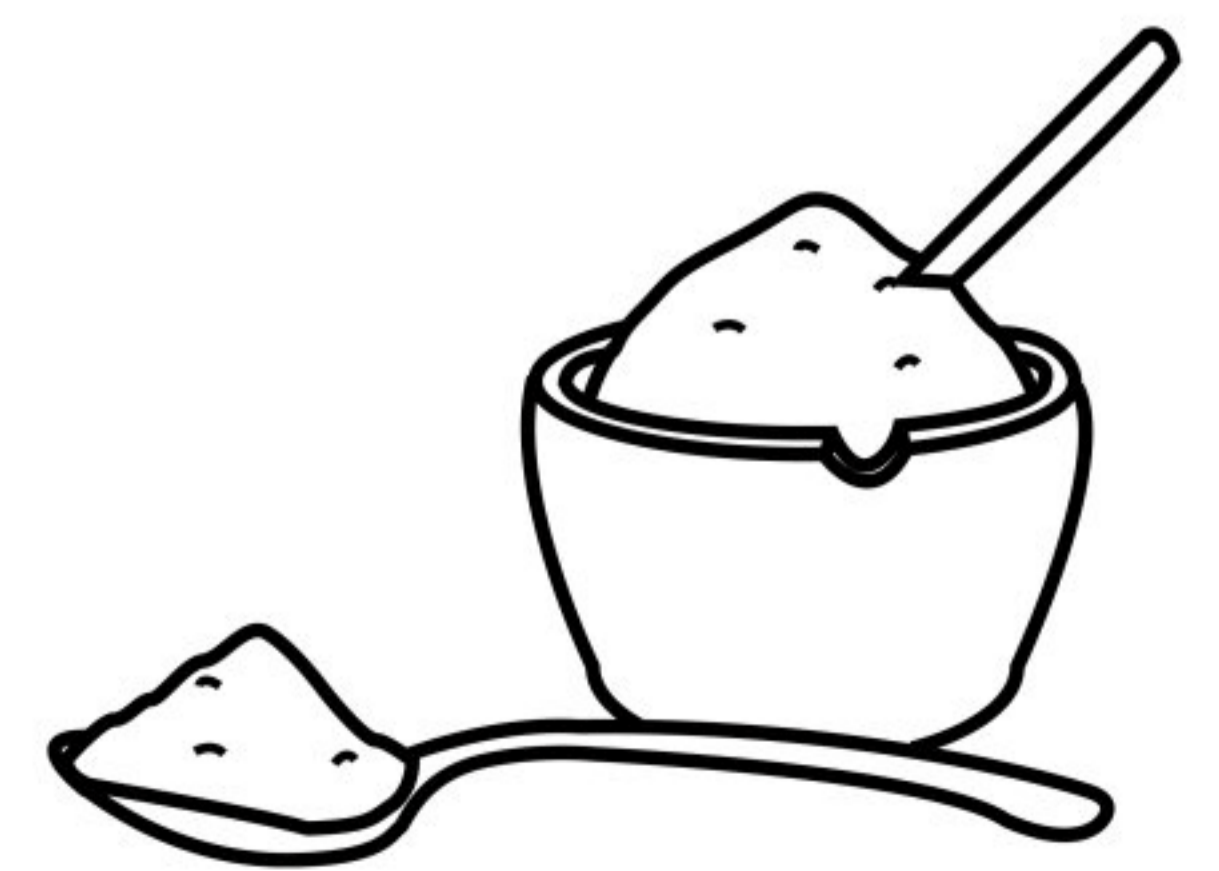

zuc ro

GHE - GHI

- Completa le parole con GHE, GHI.

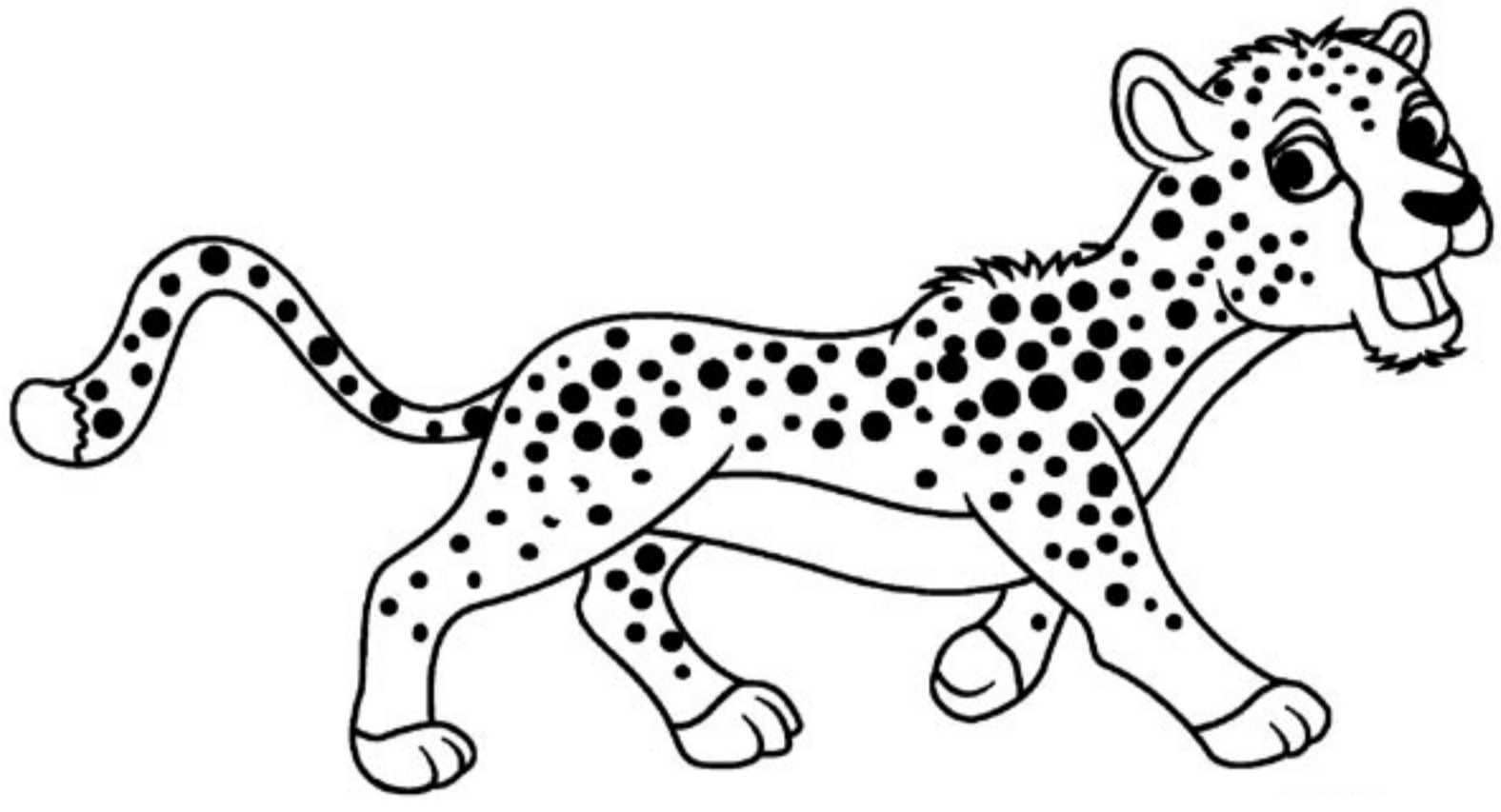

carde

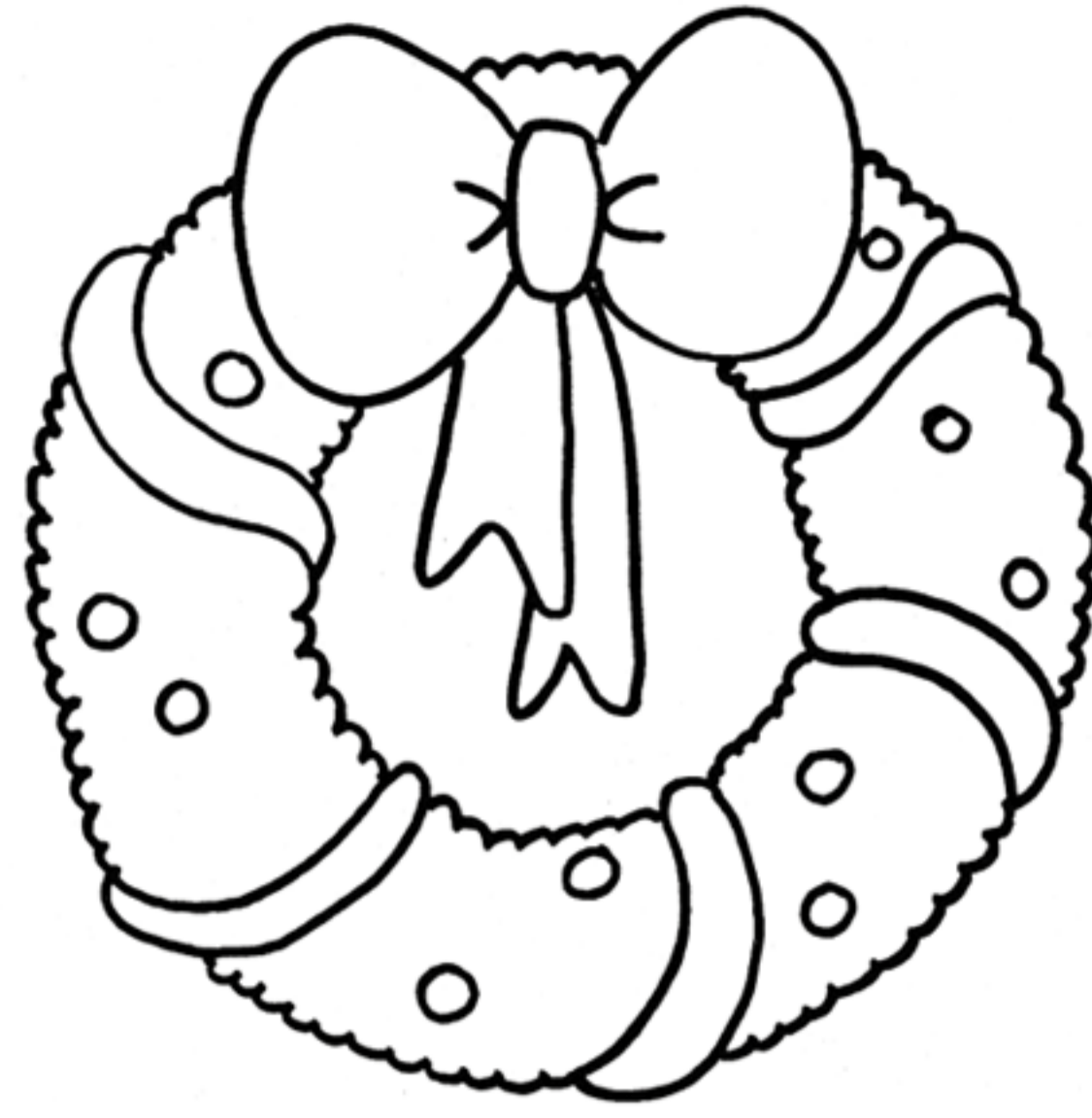

rlande

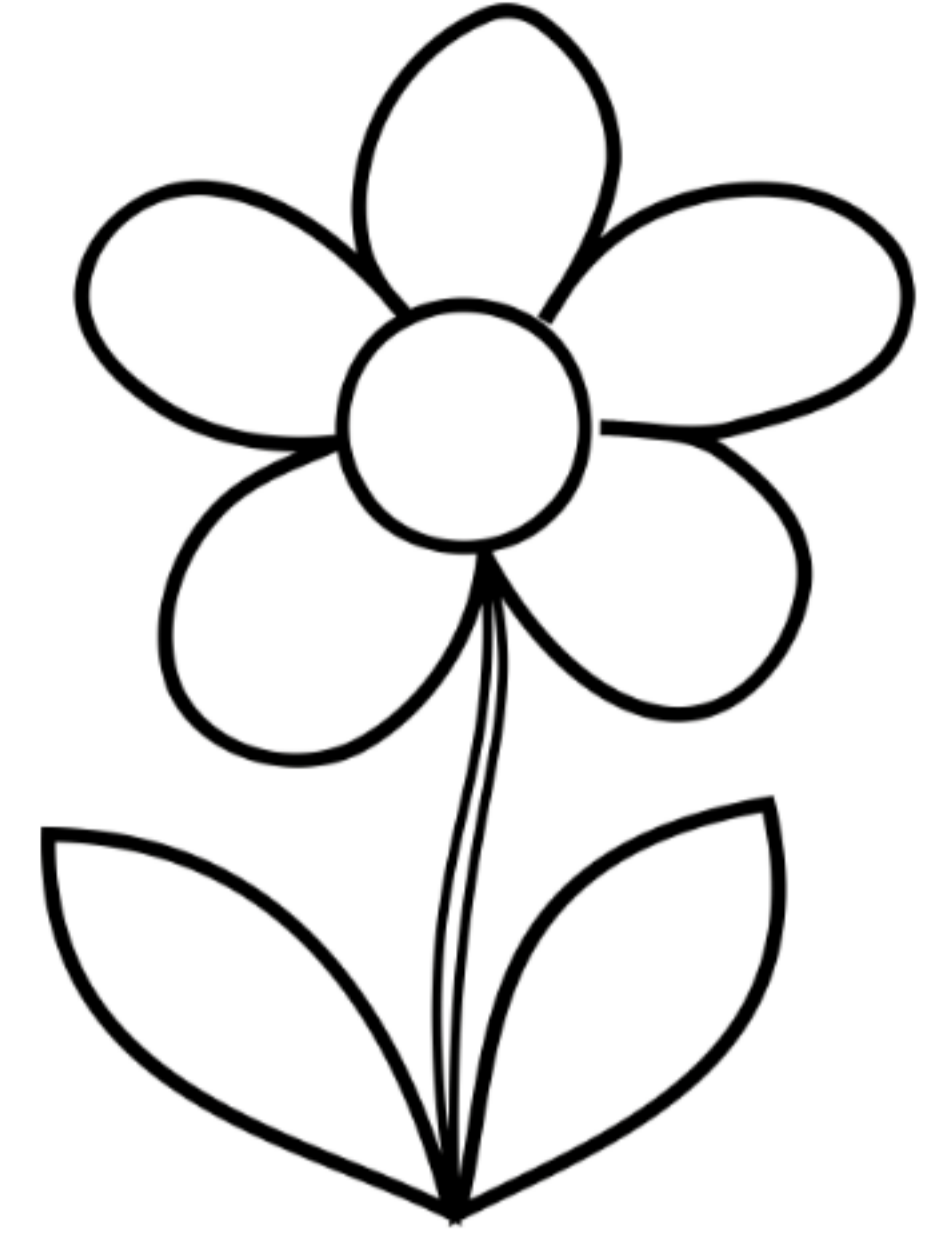

ncur

rita

Questa è una copia
dimostrativa.

Tutti i nostri eBook possono
essere acquistati sul sito.

©Pianetabambini.it

acciu

..... acciaio

..... ro

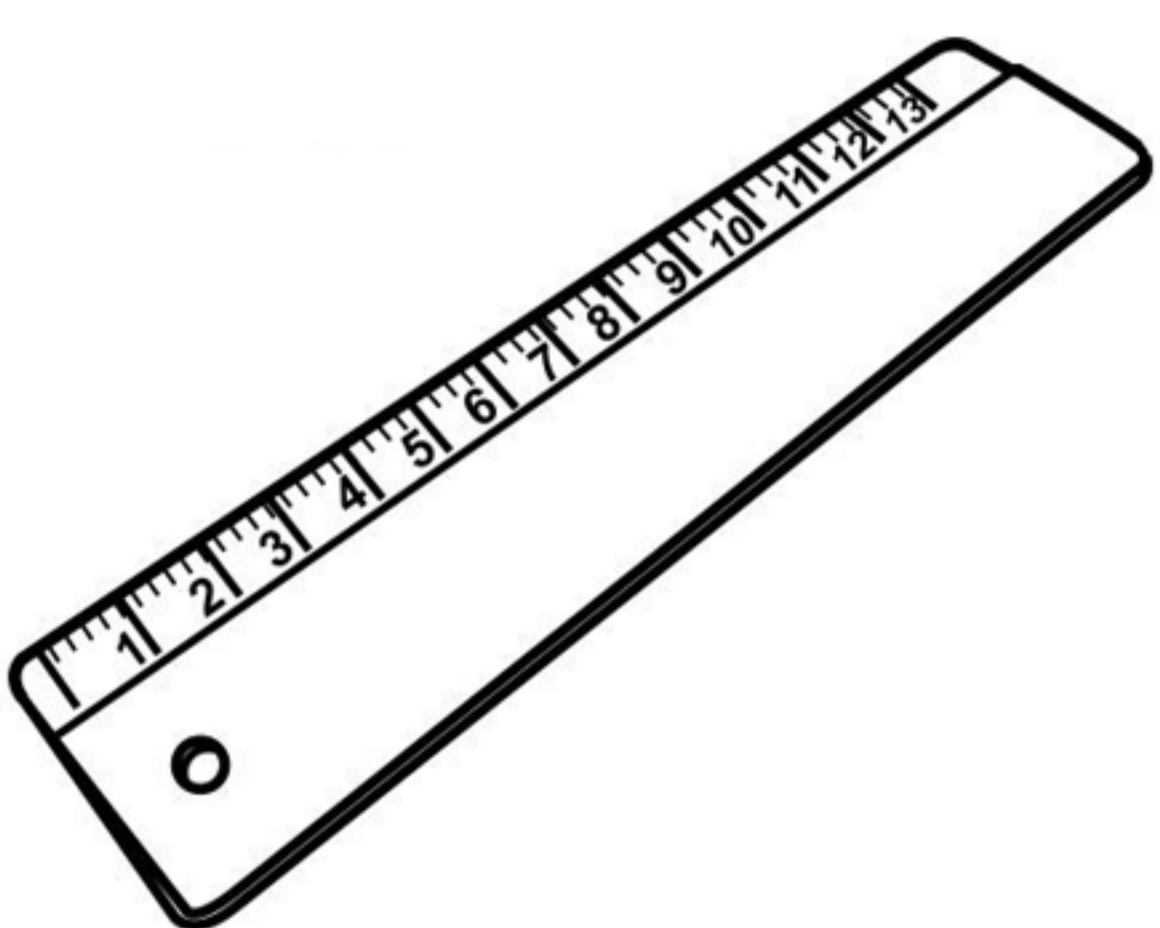

ri



stre

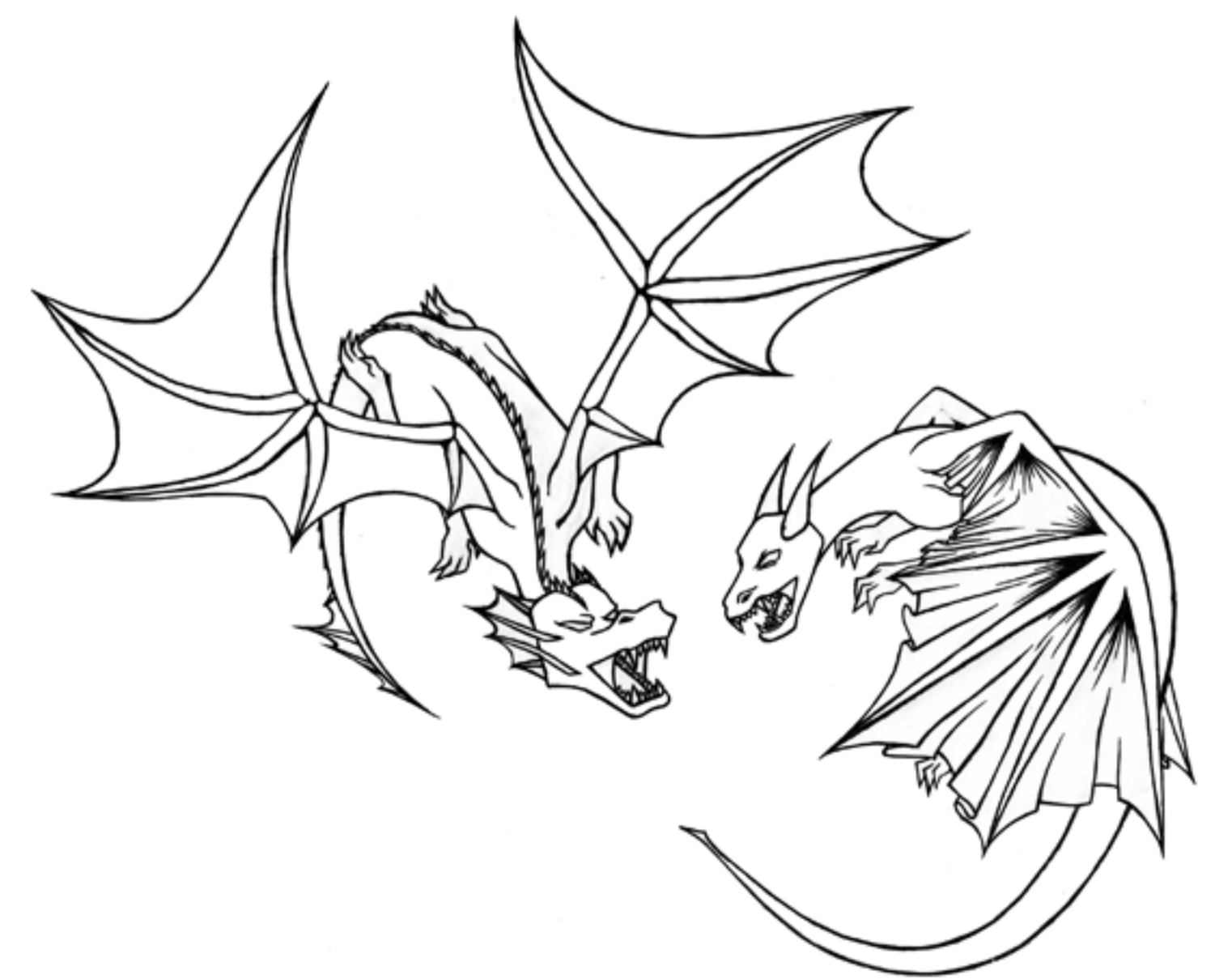

dra

SCA - SCO - SCU

- Completa le parole con SCA, SCO, SCU.

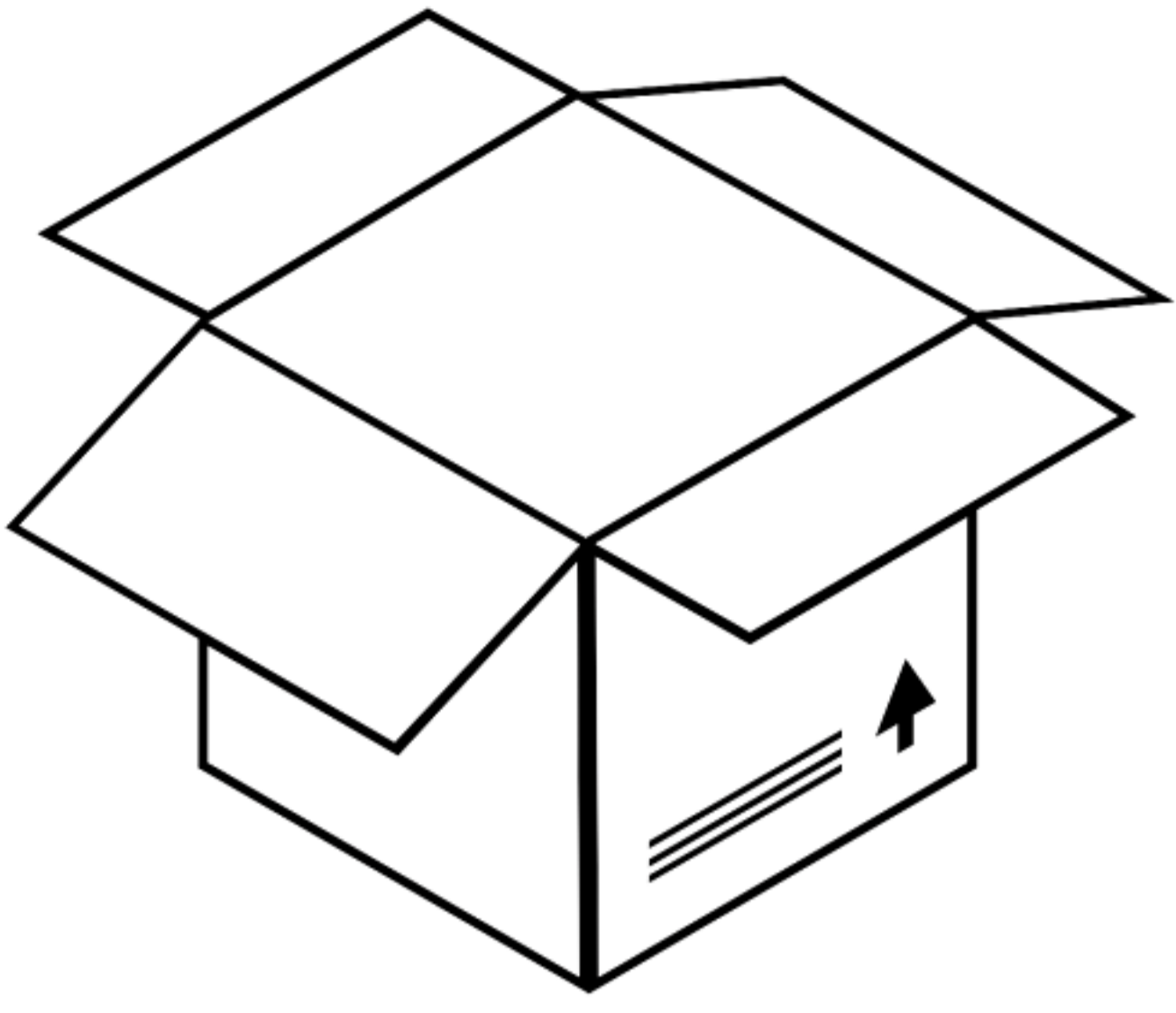

.....tola

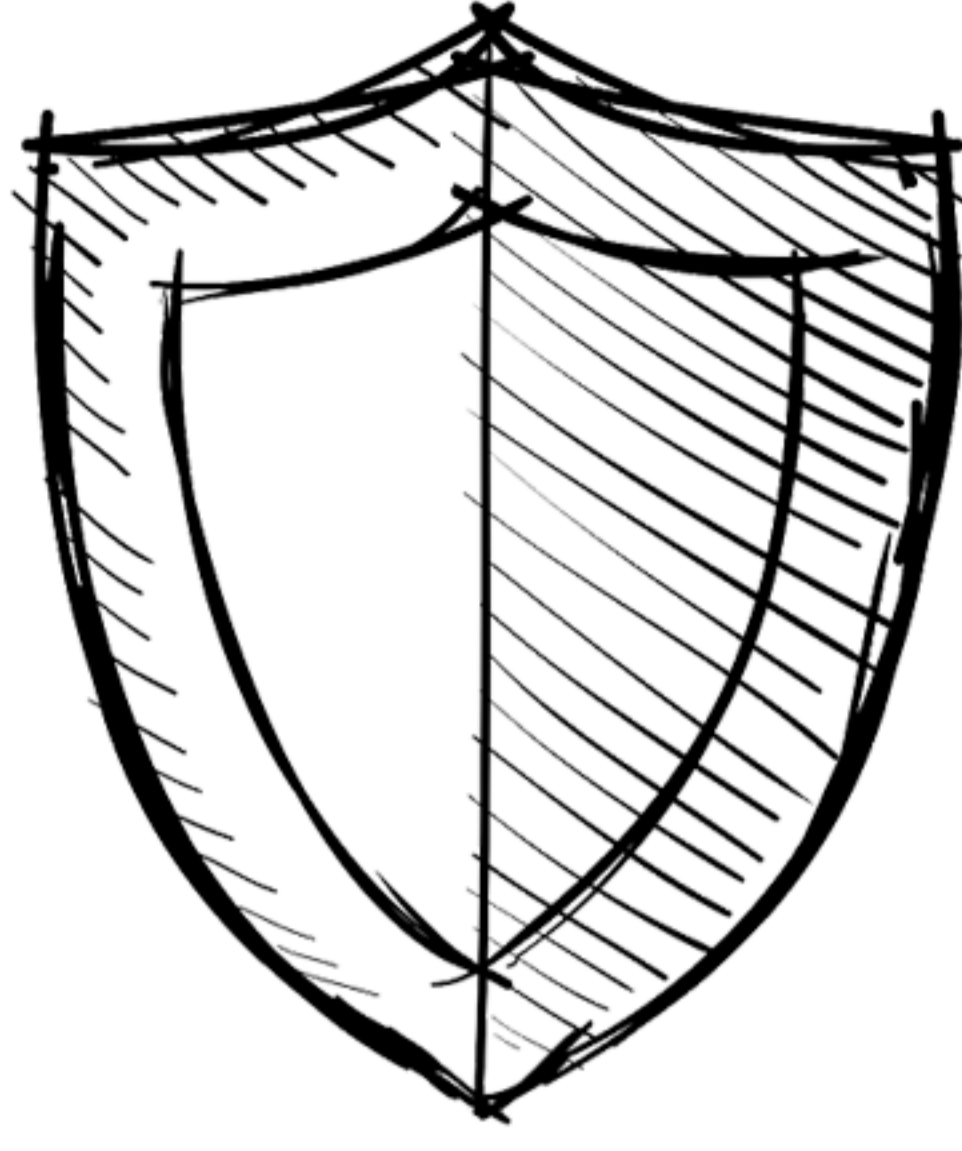

.....da



.....iattolo

Questa è una copia
dimostrativa.

Tutti i nostri eBook possono
essere acquistati sul sito.

©Pianetabambini.it

.....ola

bi.....tti

pe.....tore

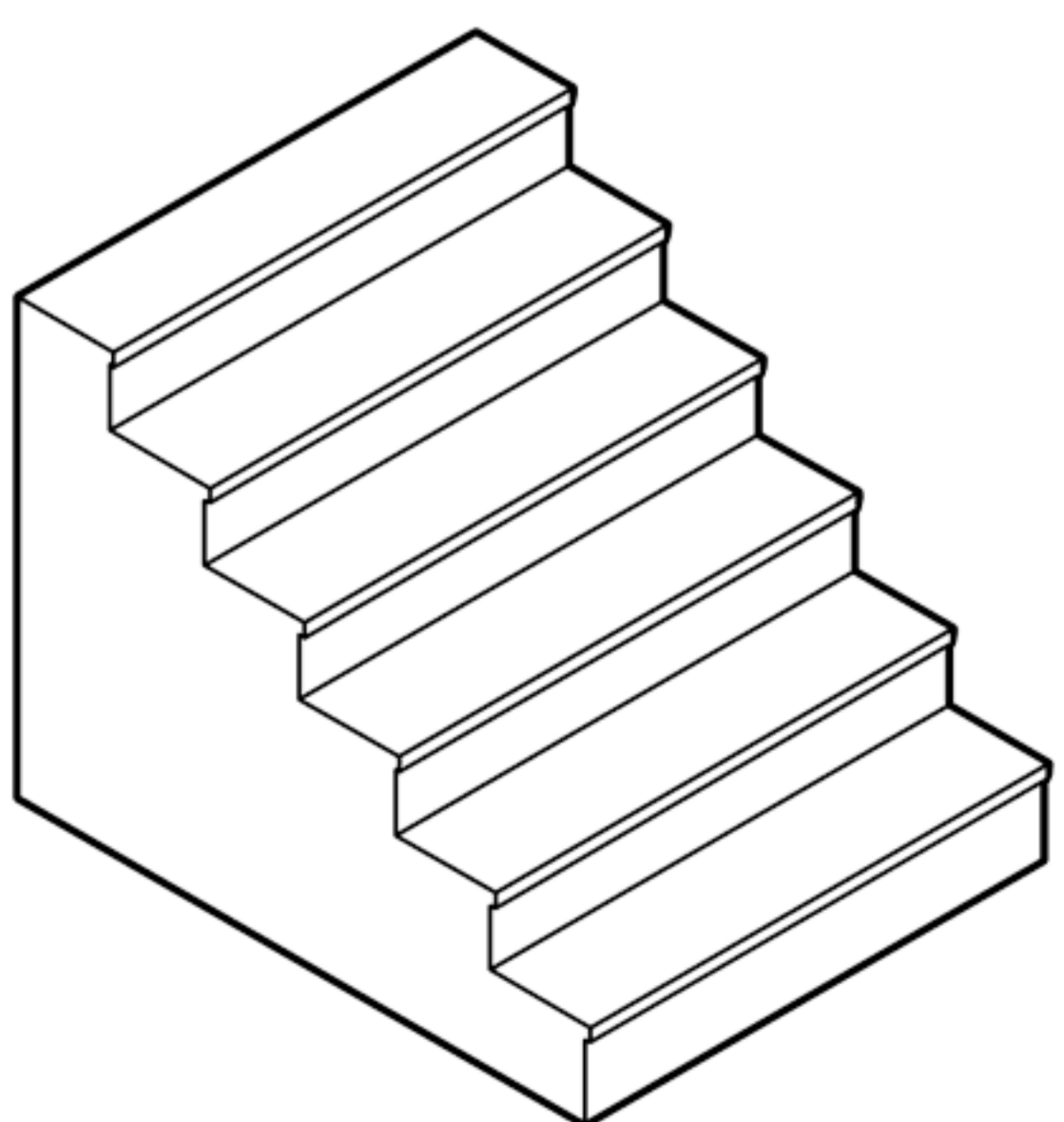

.....lini



.....rabeo

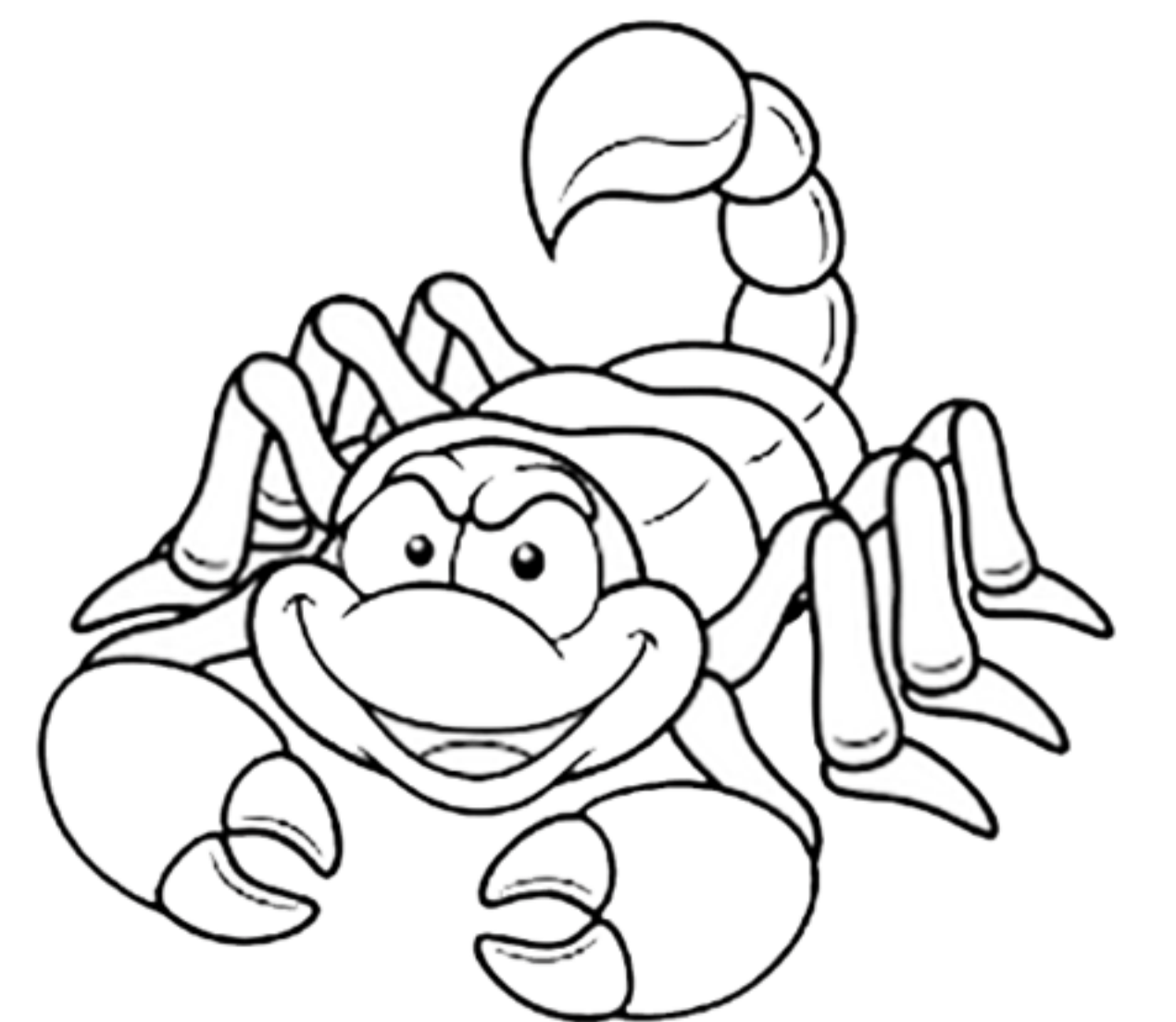

.....rpione

SCHE - SCHI

- Completa le parole con SCHE o SCHI.



letre

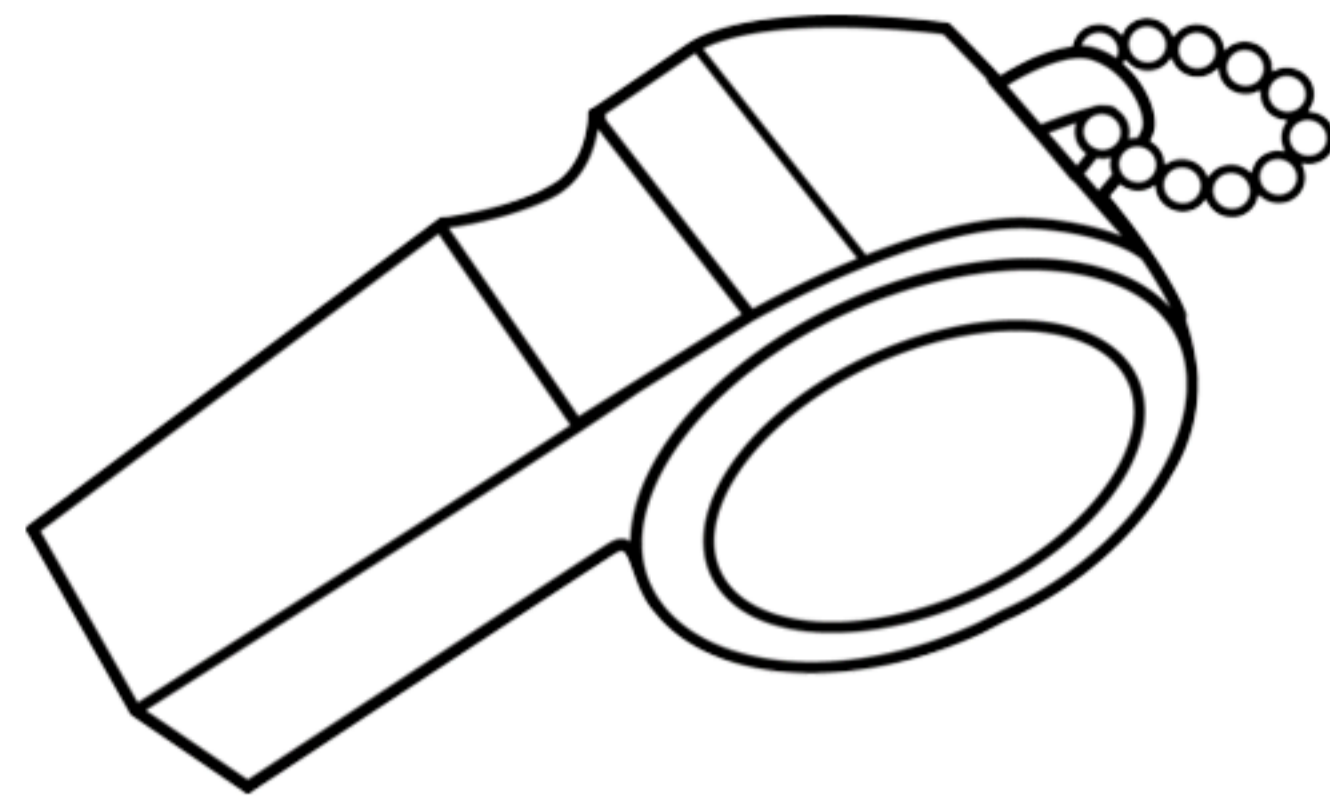

f...etto



ma...ra

Questa è una copia
dimostrativa.

Tutti i nostri eBook possono
essere acquistati sul sito.

©Pianetabambini.it

..... de

vi..... o

..... affo



pe..... ria



..... ena

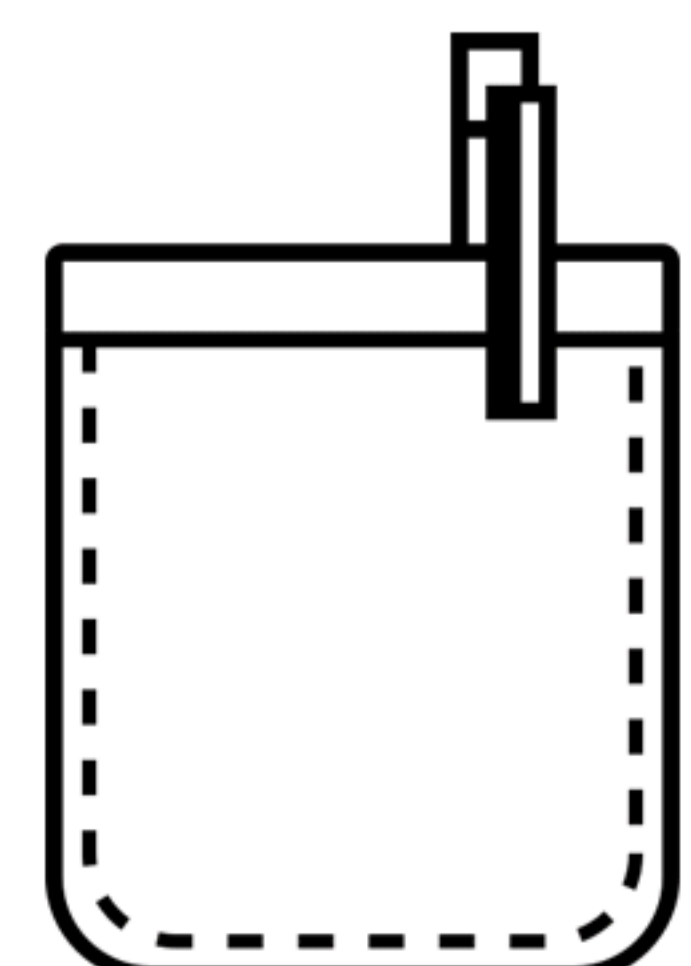

ta..... no

SCE - SCI

- Completa le parole con SCE o SCI.

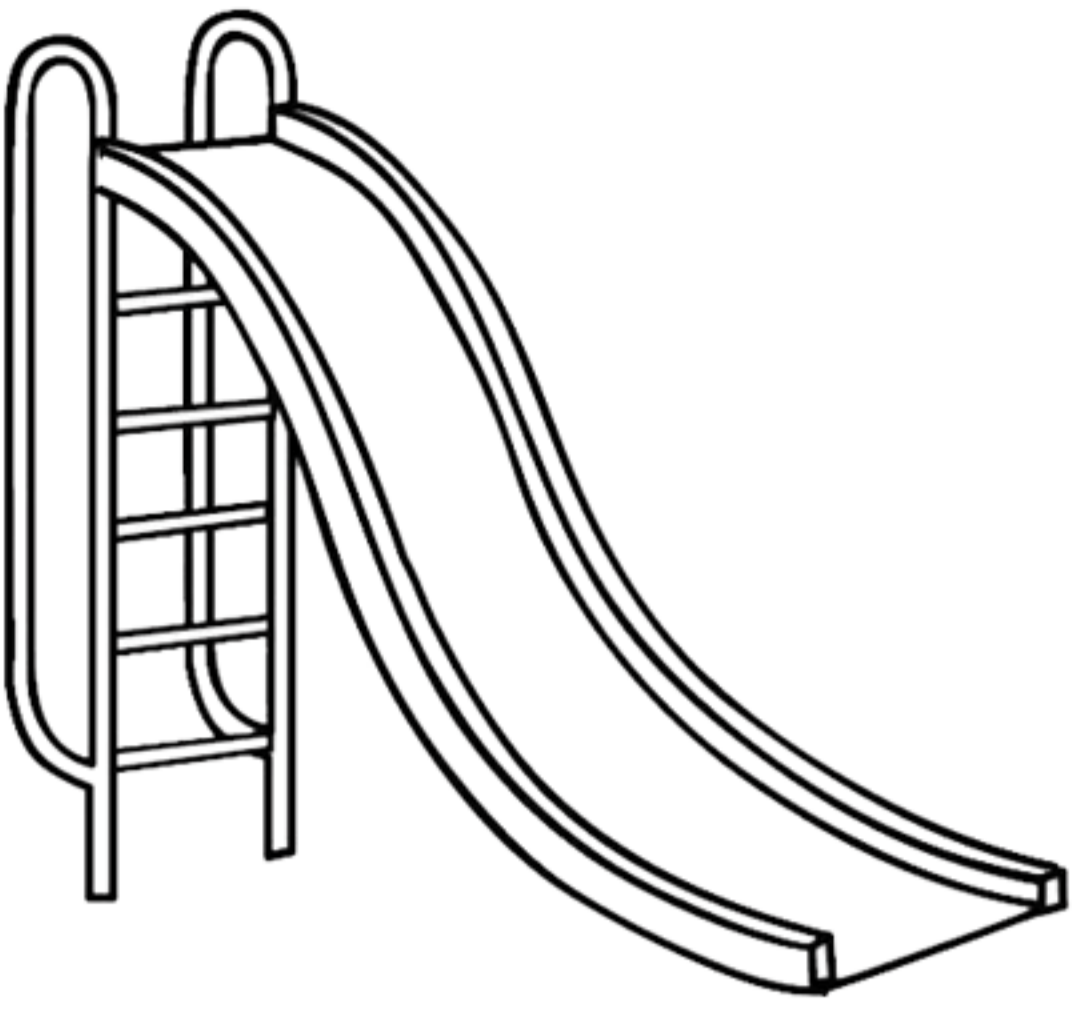

va lo

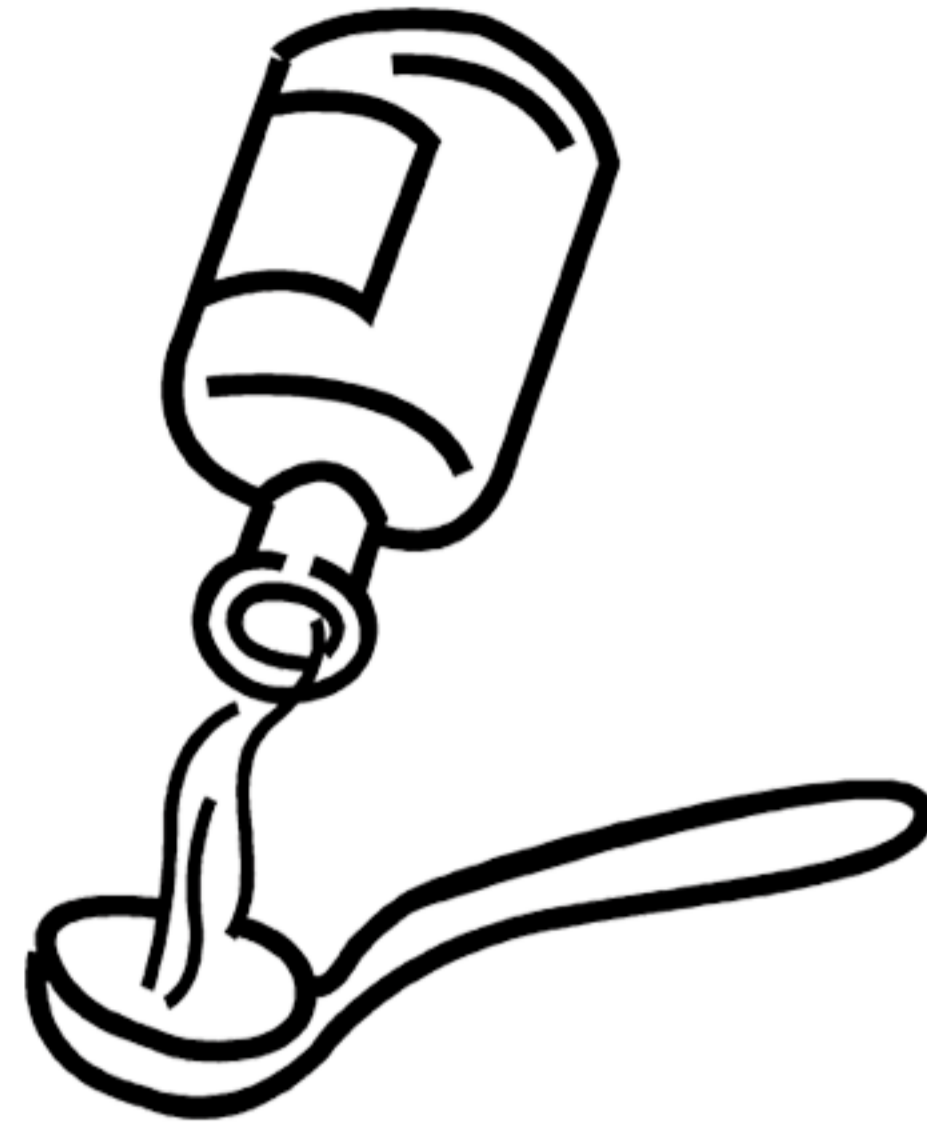

ran



rifo

Questa è una copia dimostrativa.
Tutti i nostri eBook possono essere acquistati sul sito.
©Pianetabambini.it

va llo

..... mmia

cu no

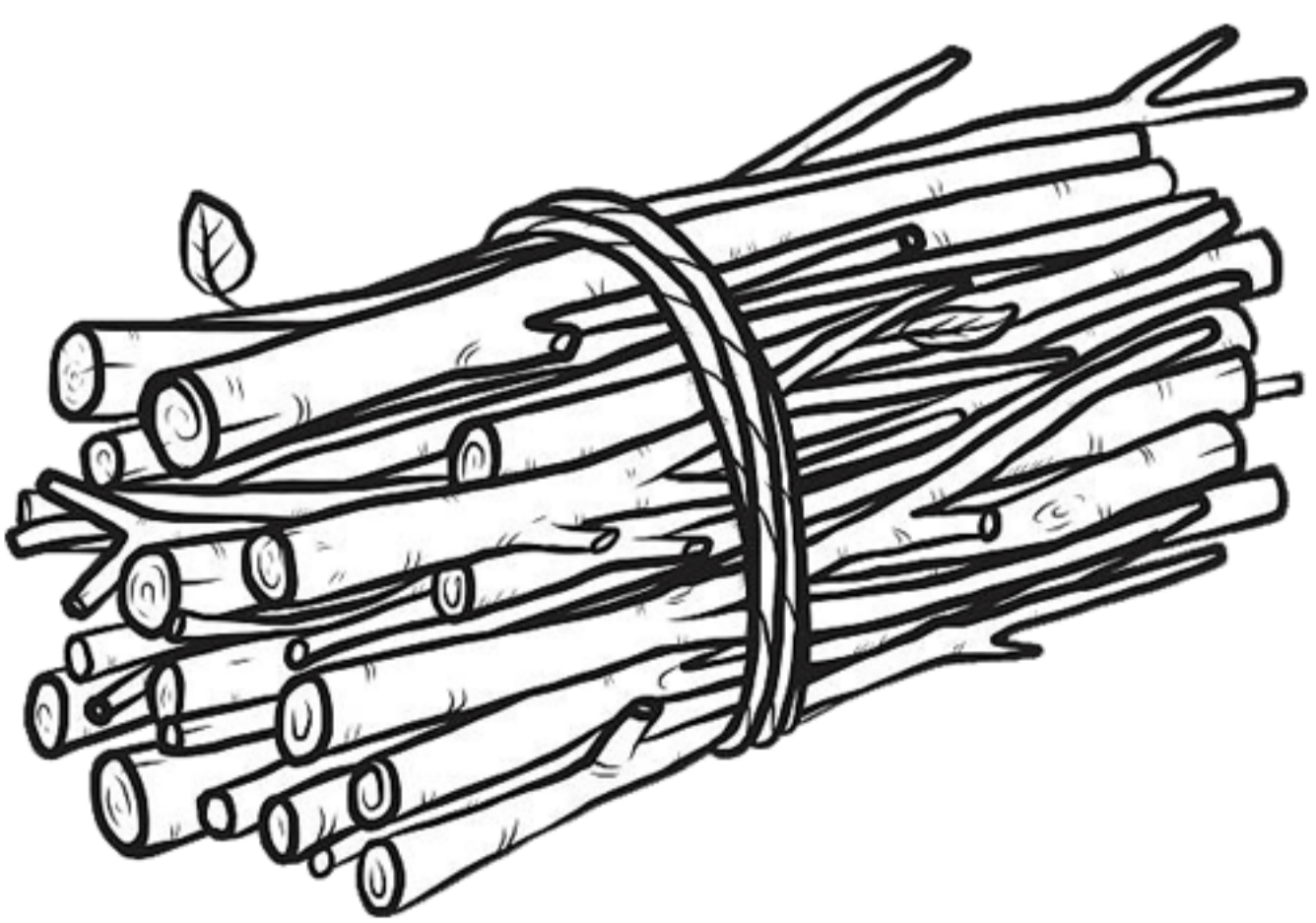

fa na



ru llo

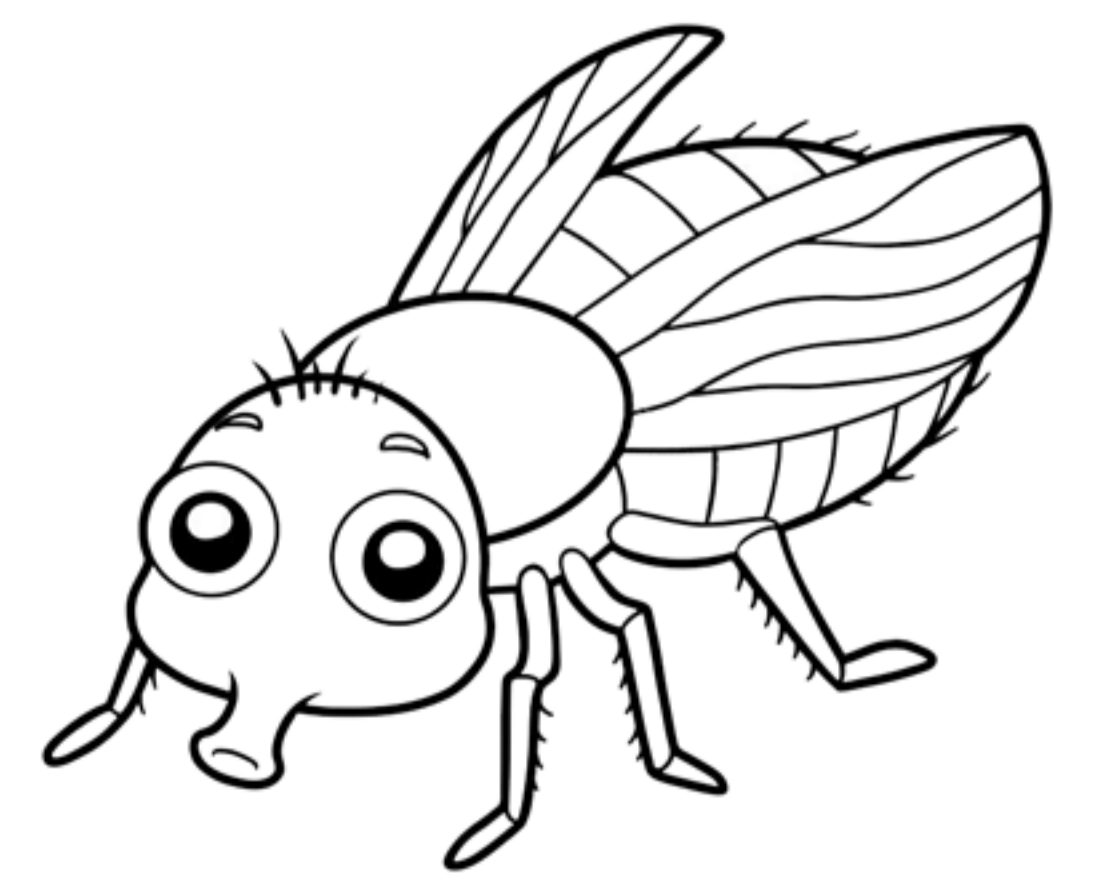

mo rino

SCIA - SCIO - SCIU

- Completa le parole con SCIA, SCIO, SCIU.

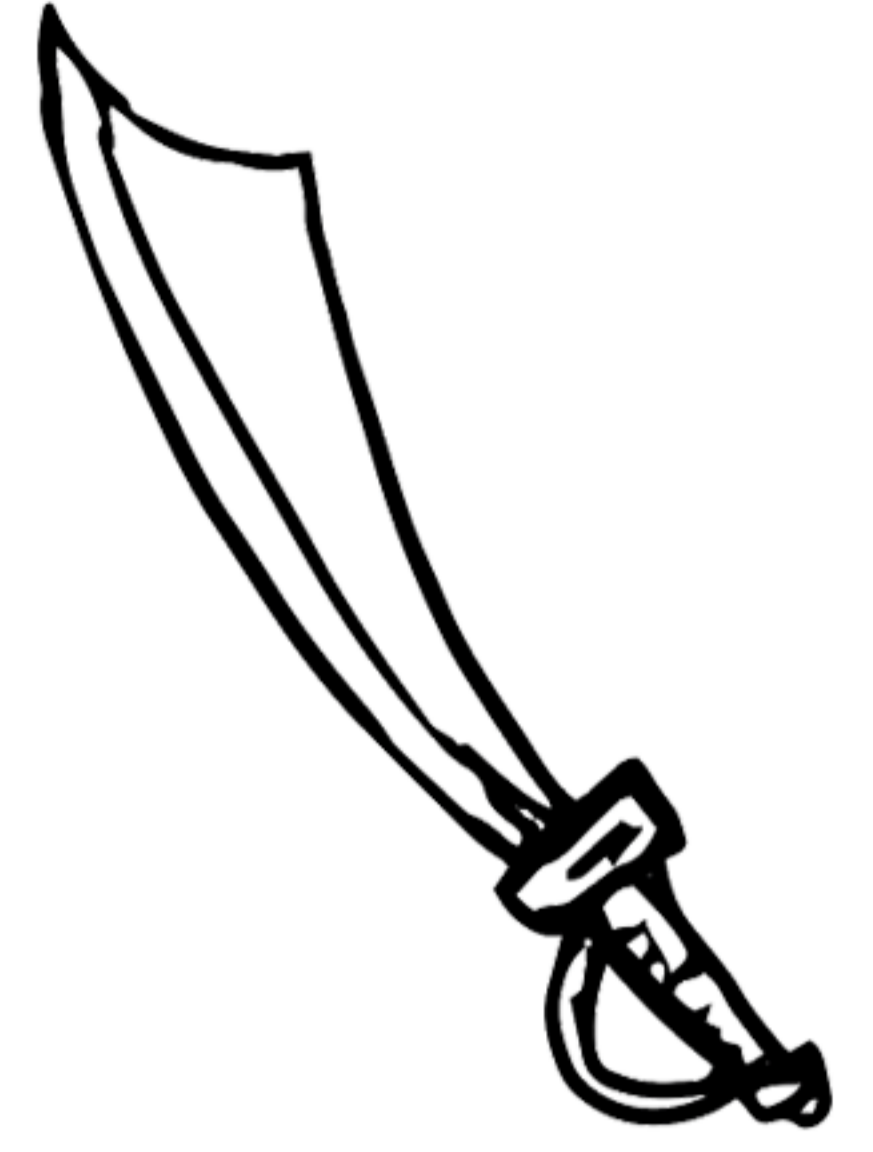
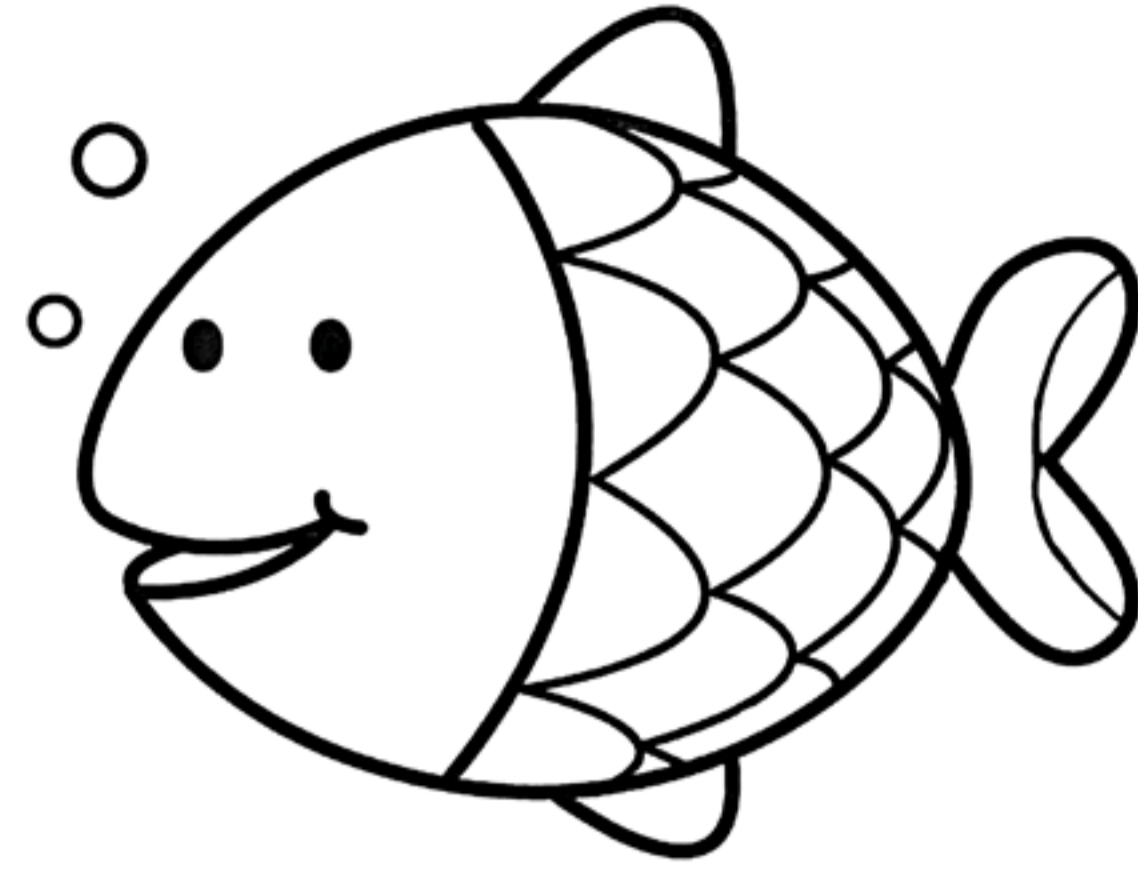

Questa è una copia
dimostrativa.

Tutti i nostri eBook possono
essere acquistati sul sito.

©Pianetabambini.it

pro tto

..... callo

..... me

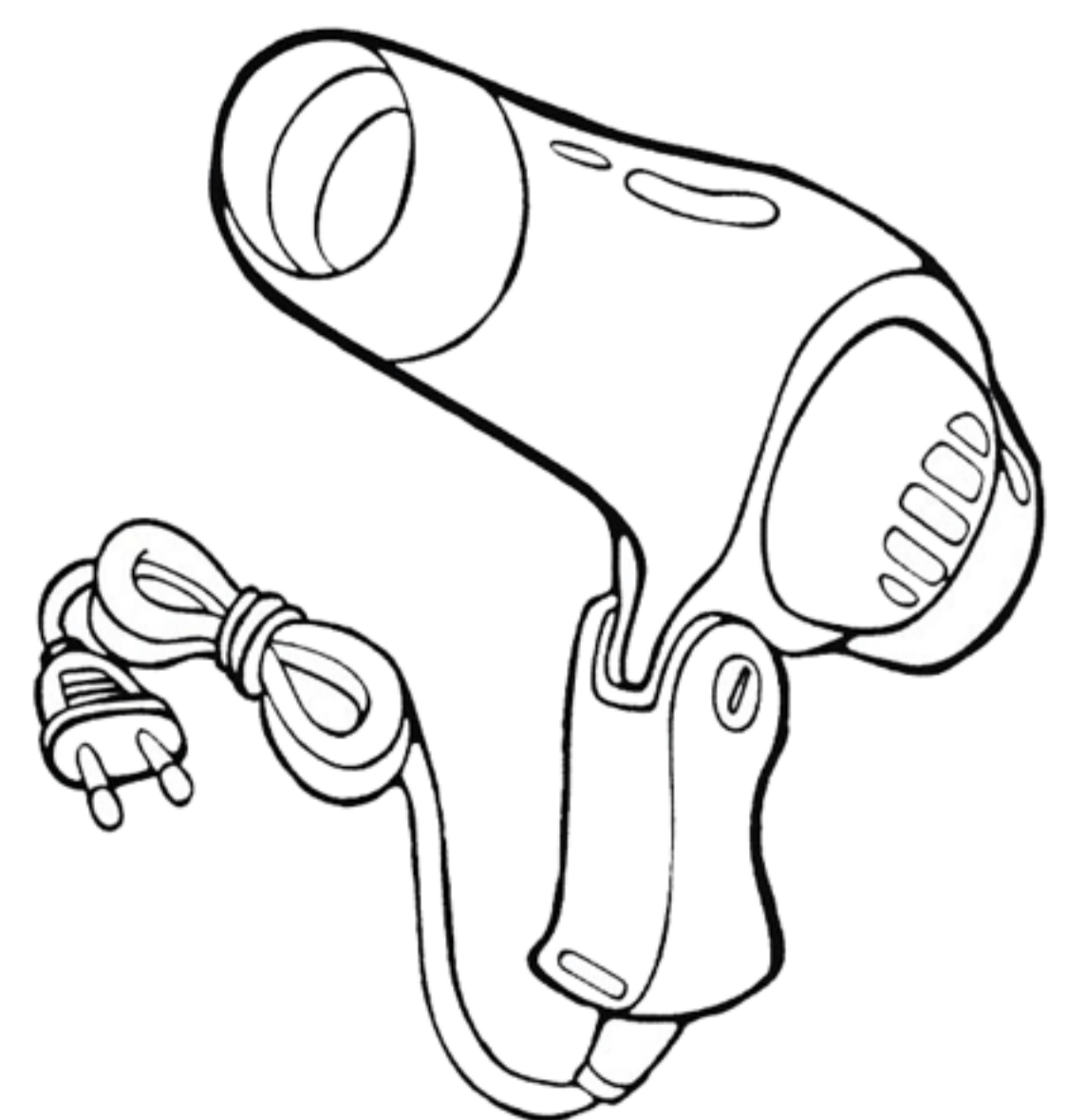
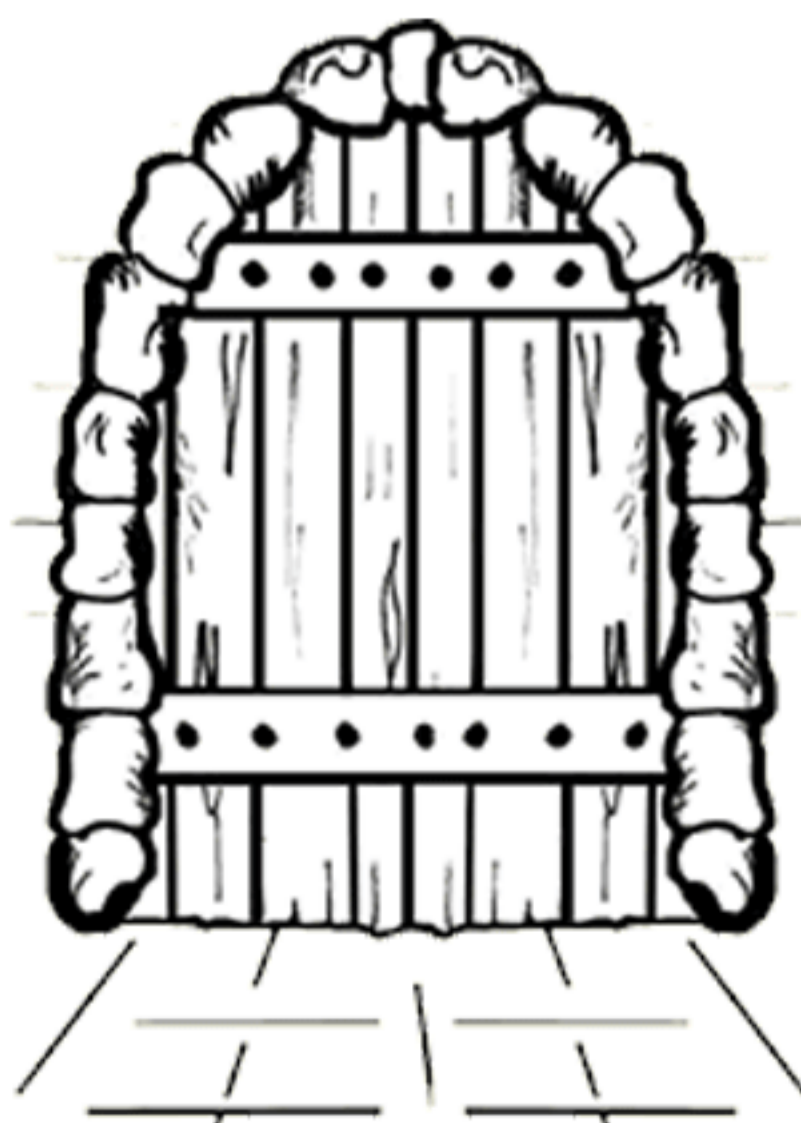
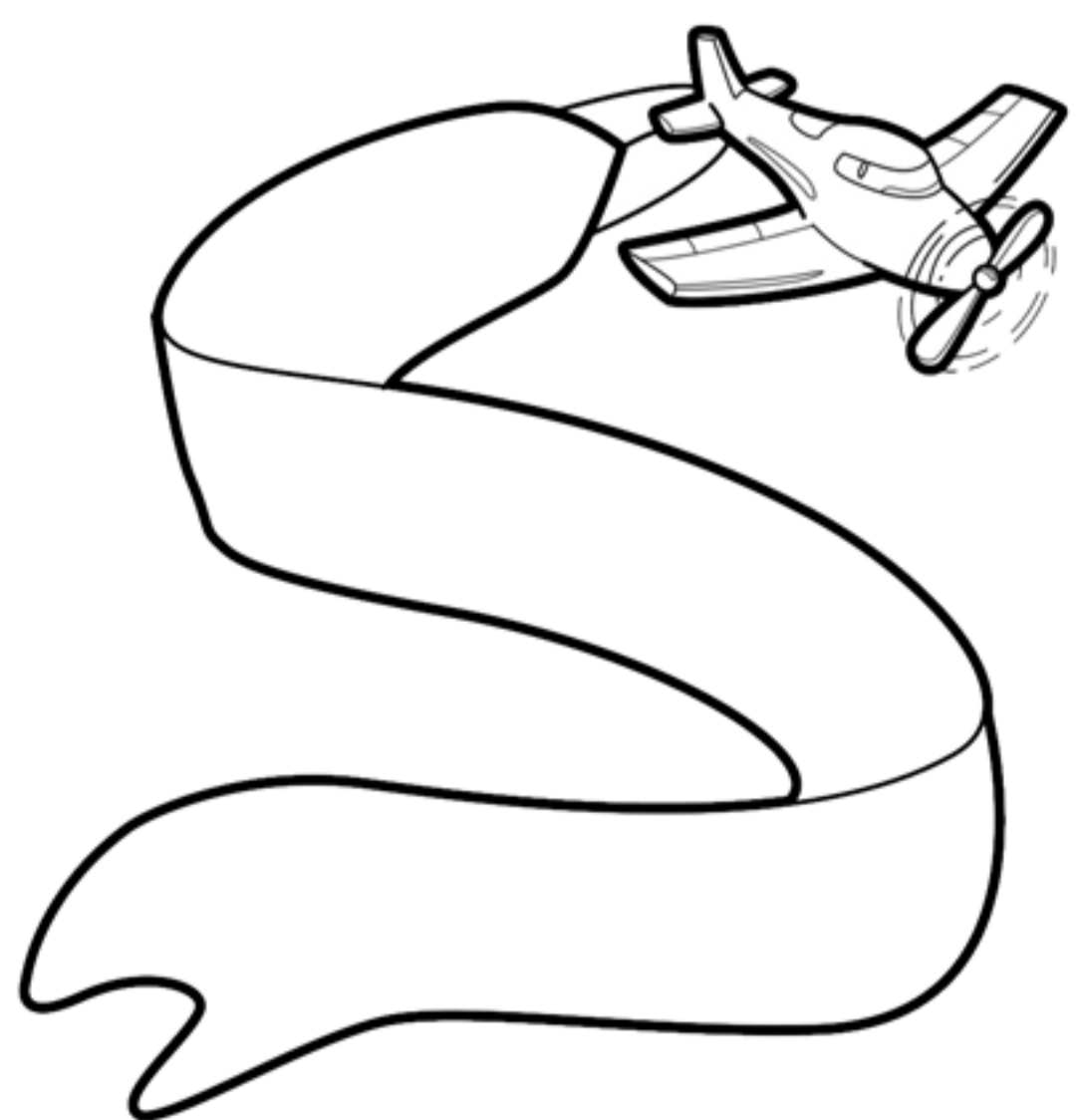

stri ne

u

a gacapelli

- Completa le parole con GLI.

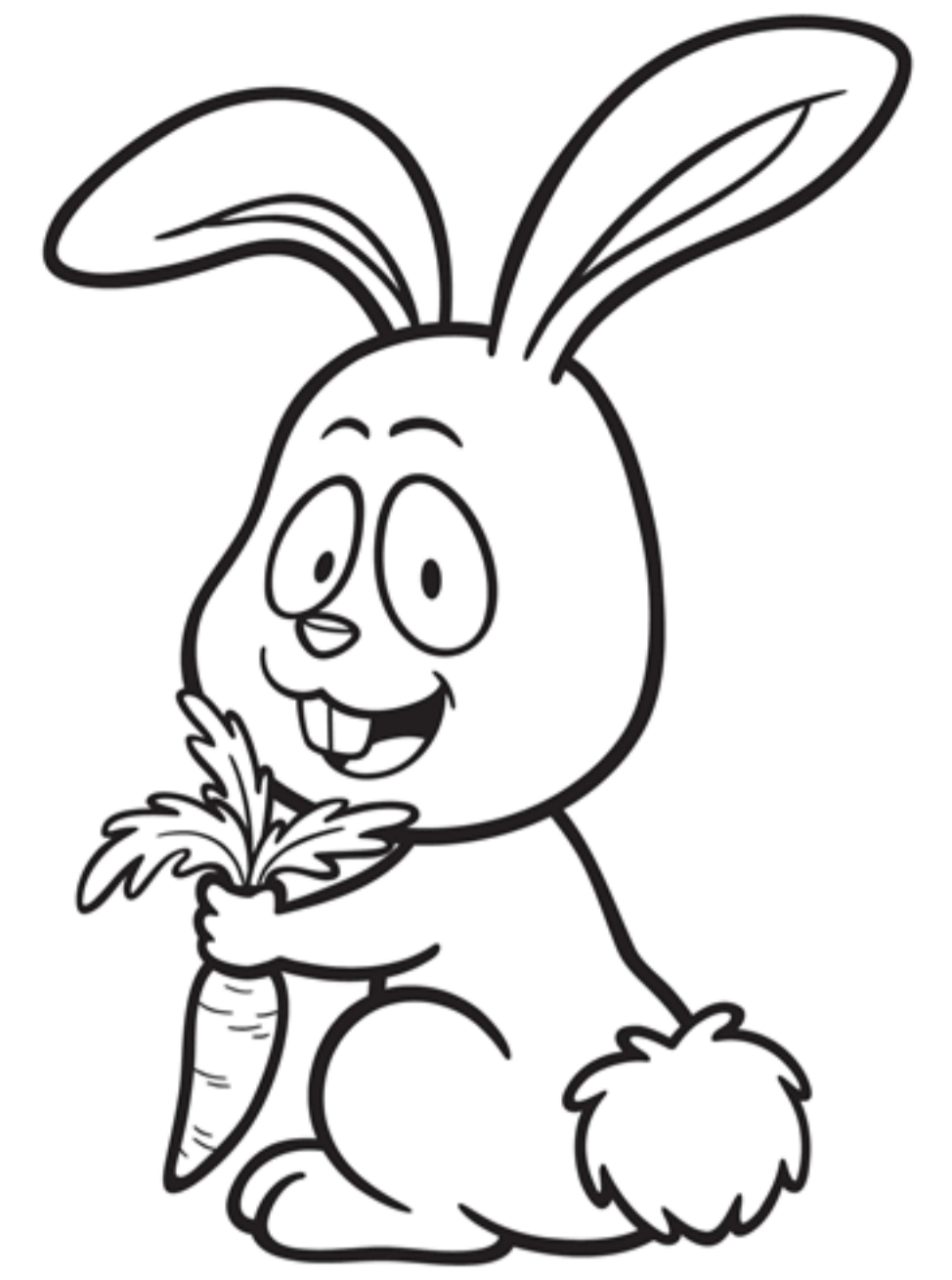

Questa è una copia
dimostrativa.

Tutti i nostri eBook possono
essere acquistati sul sito.

©Pianetabambini.it

a o

conchi a

bi e

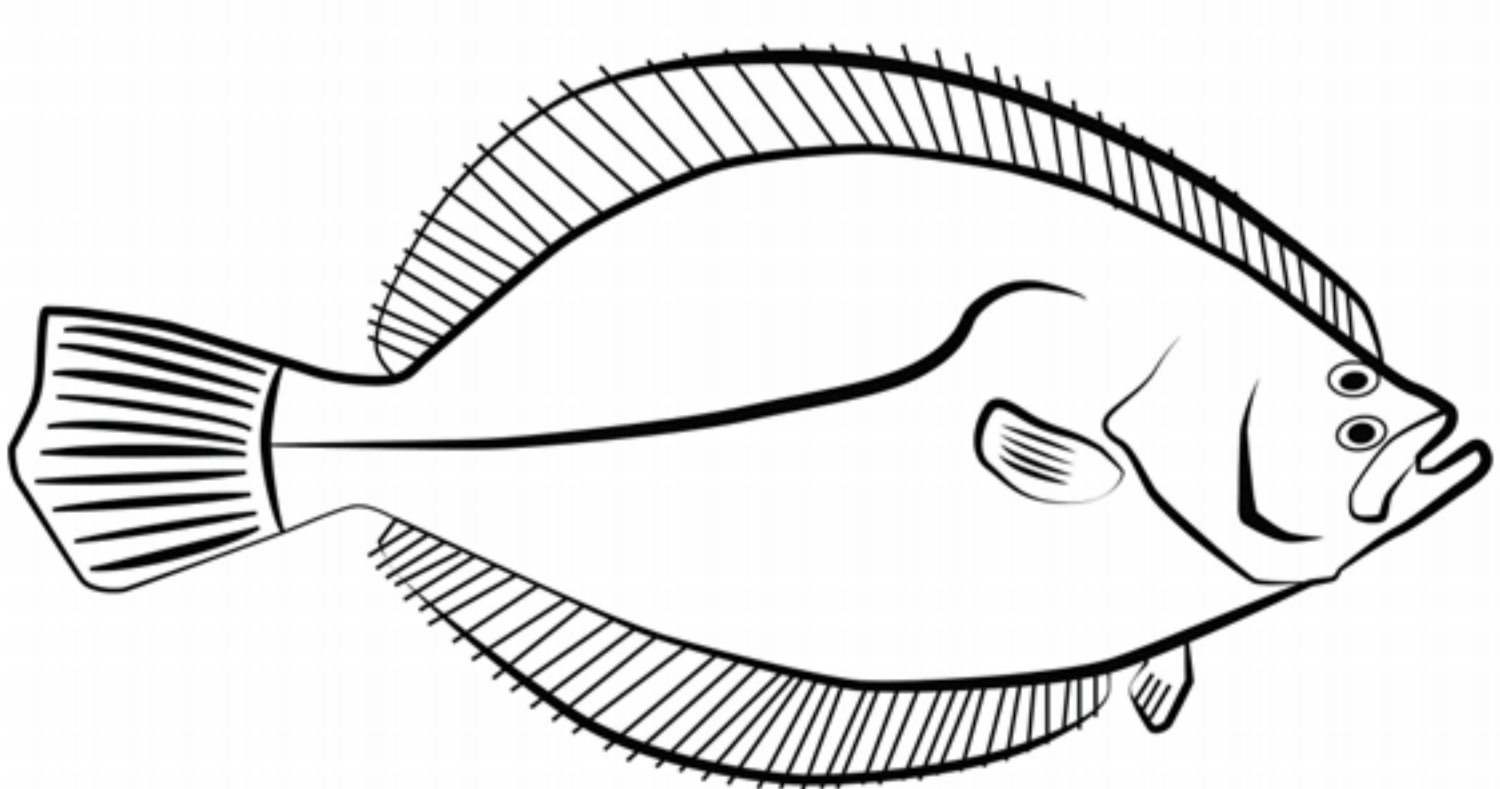

so ola

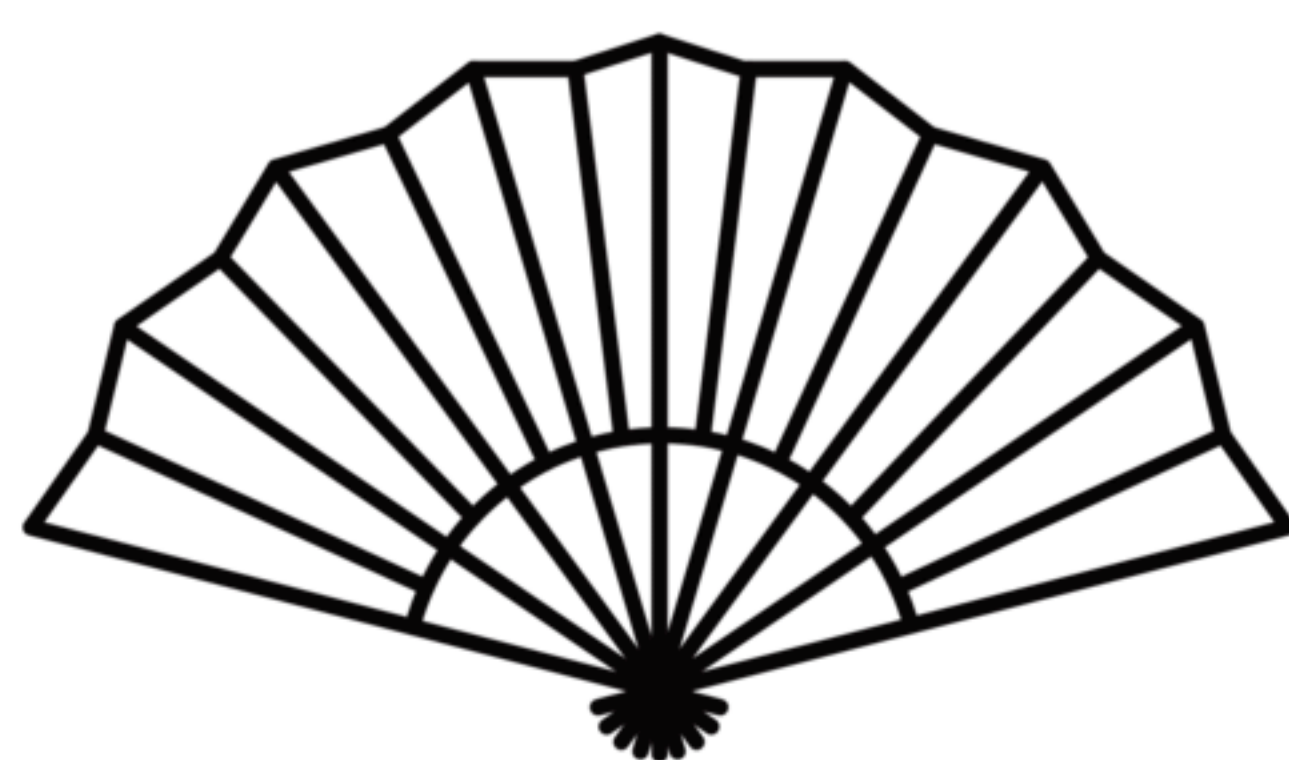

venta o

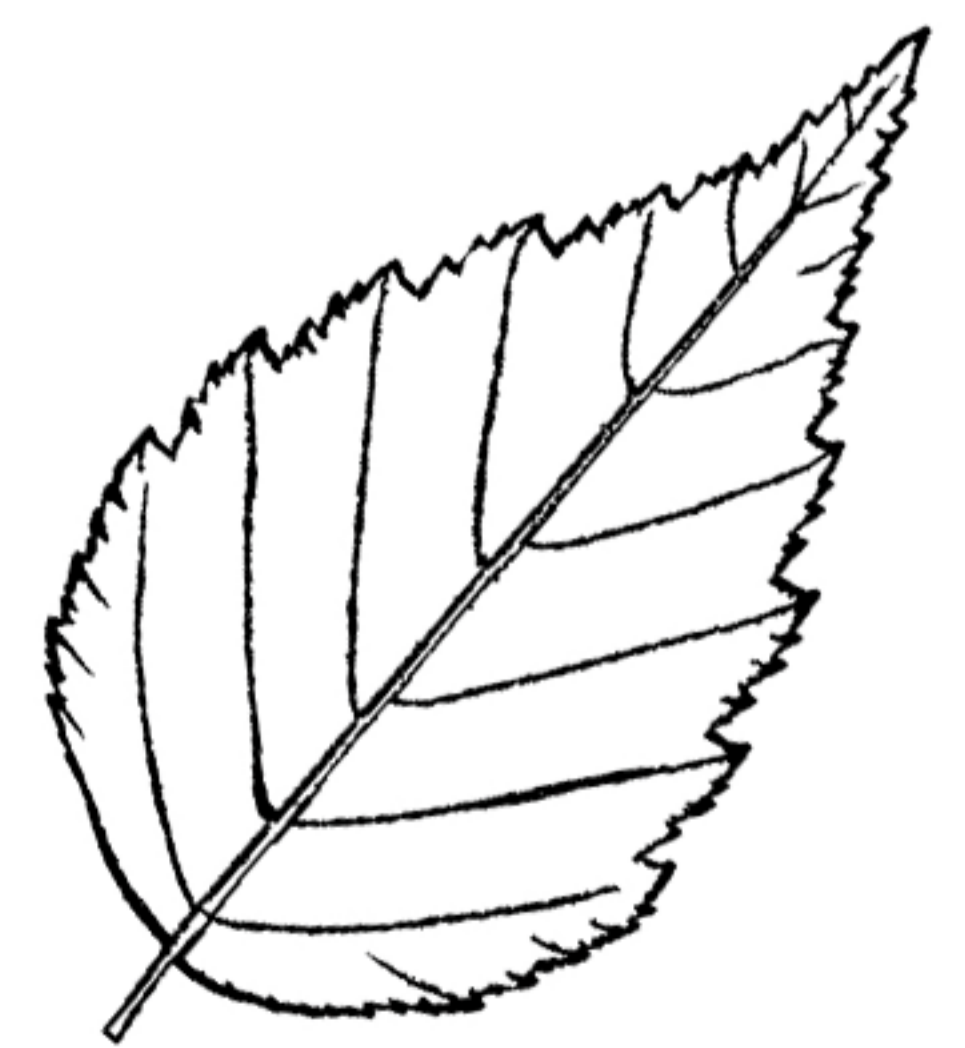

fo a

- Completa le parole con GNA, GNE, GNI, GNO, GNU.

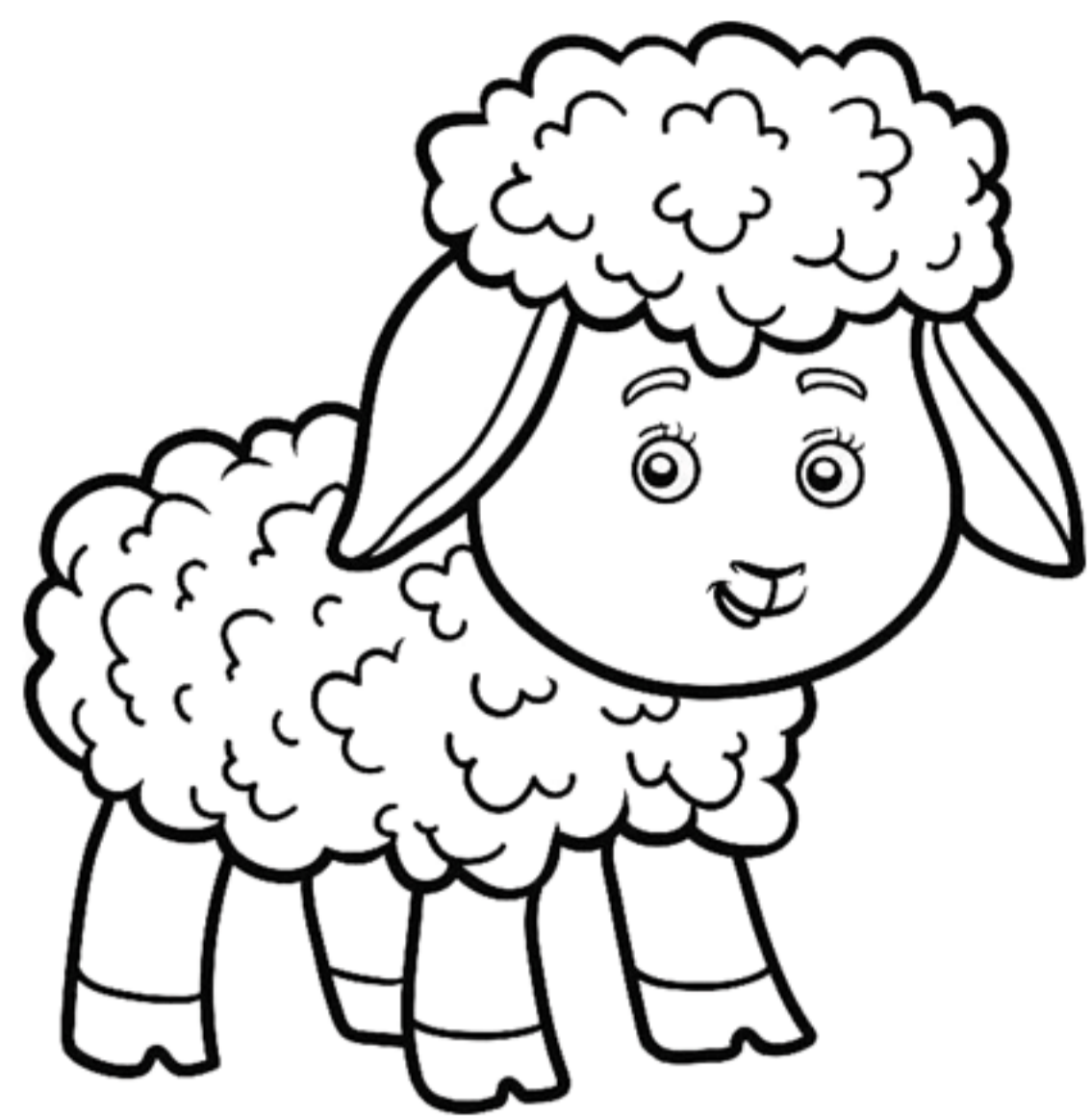

a llo

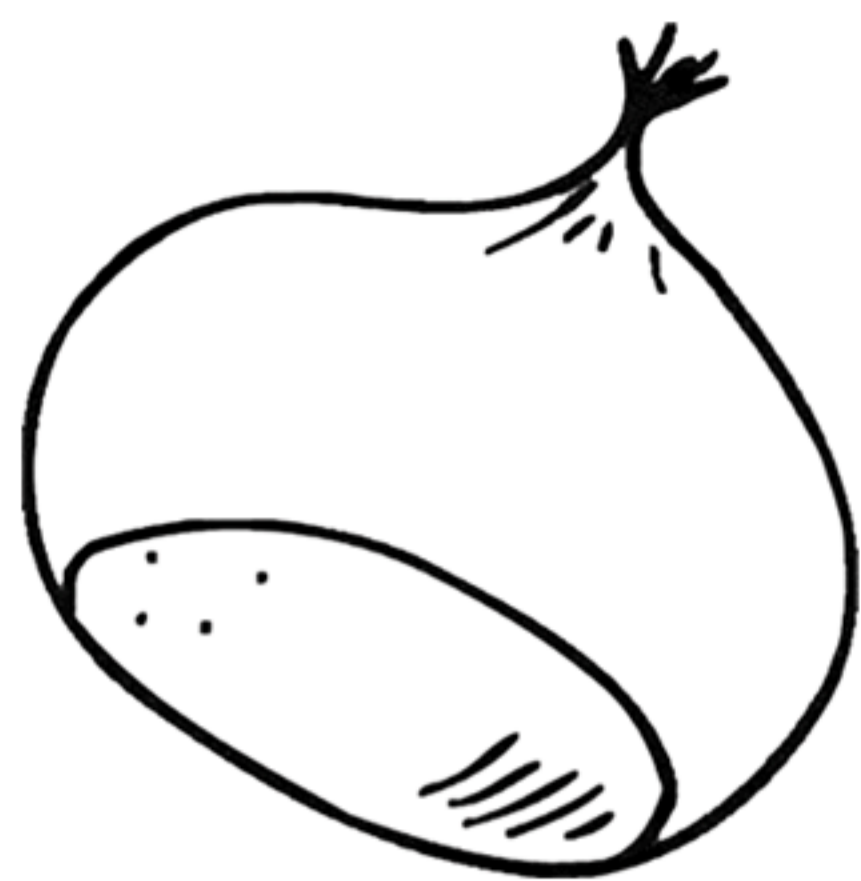

casta



uci lo

Questa è una copia
dimostrativa.

Tutti i nostri eBook possono
essere acquistati sul sito.

©Pianetabambini.it

ci

pru

ra



lasa

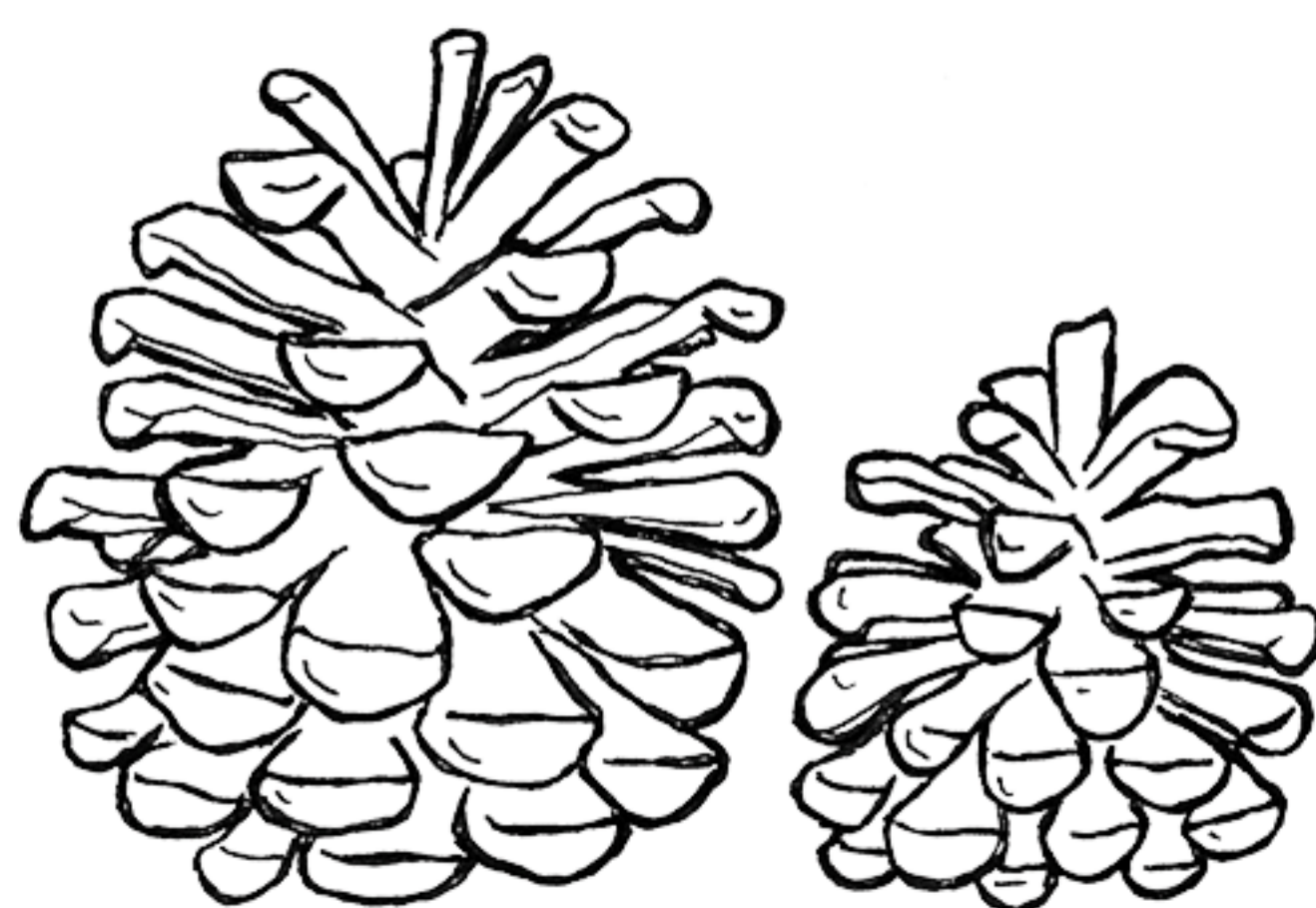

pi



ba no

CU - QU

- Completa le parole con CU o QU.

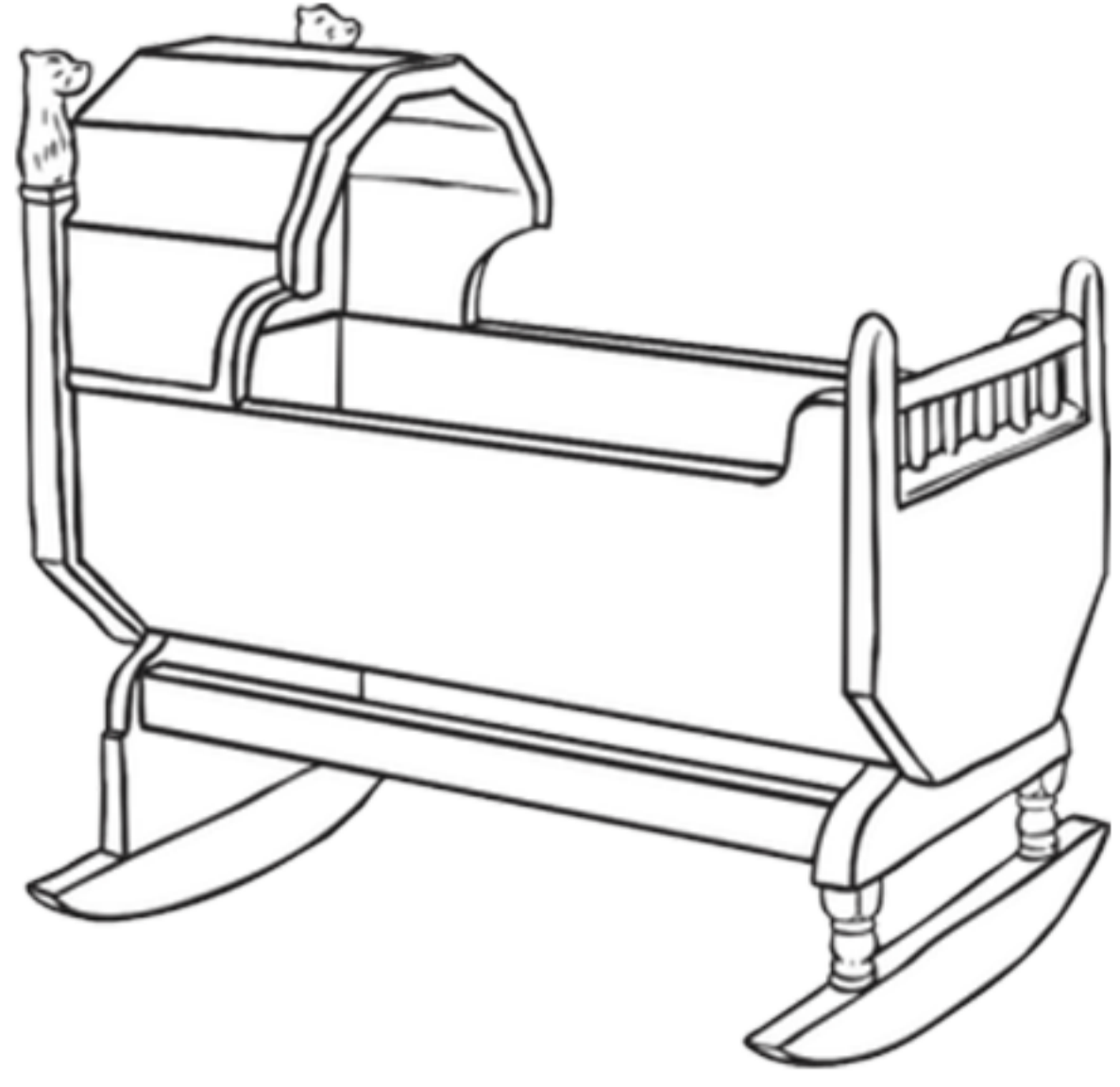

lla

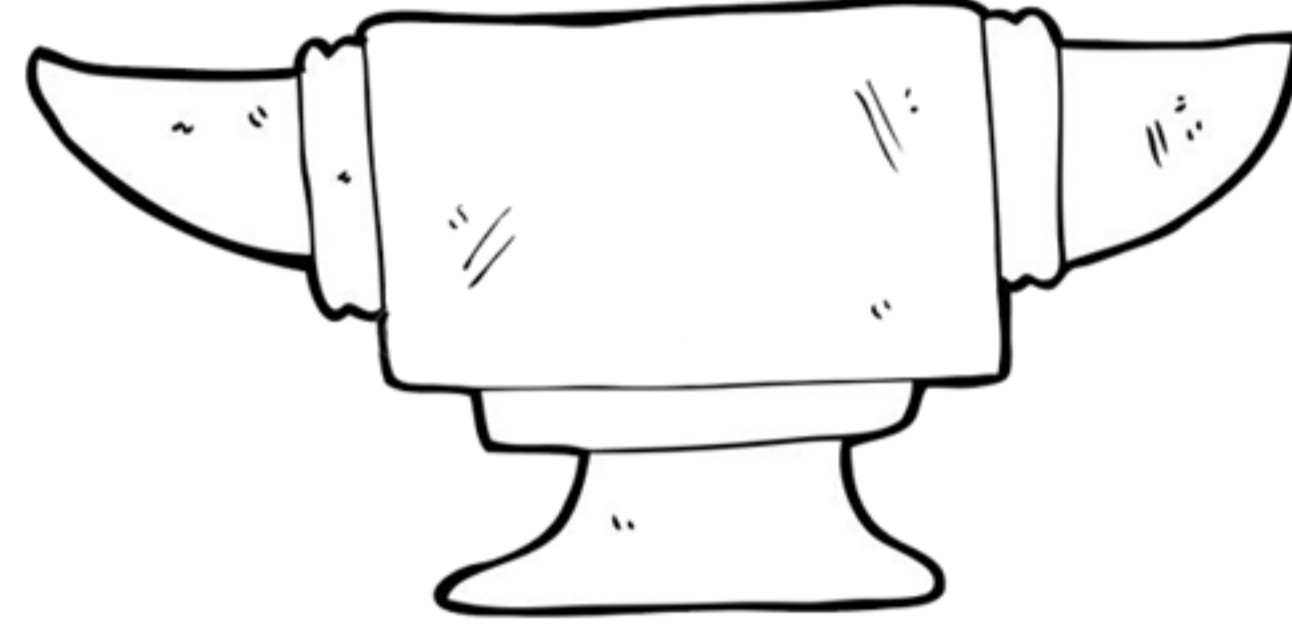

in dino

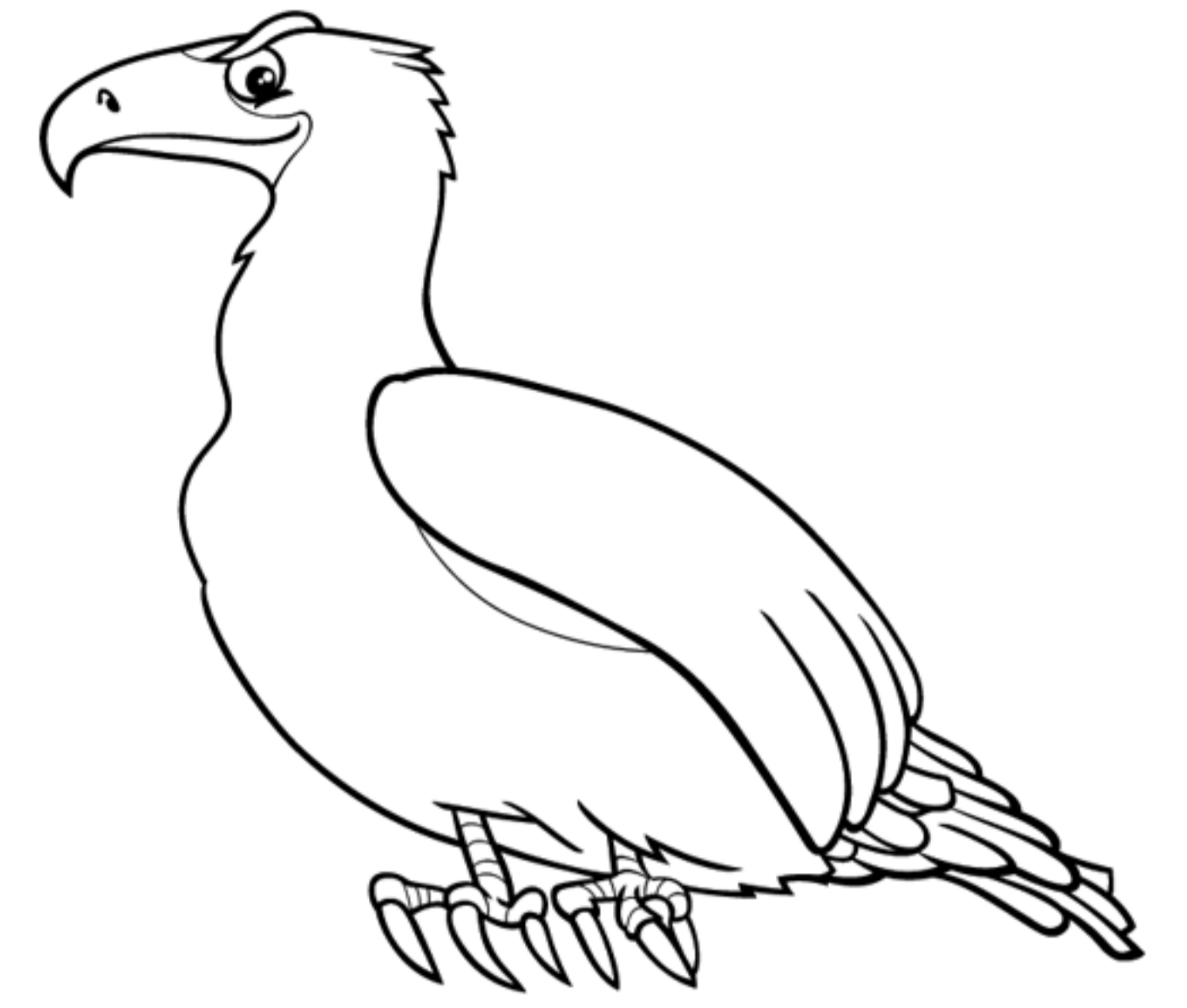

a ila

Questa è una copia
dimostrativa.

Tutti i nostri eBook possono
essere acquistati sul sito.

©Pianetabambini.it

..... aglia

..... aderno

s ola

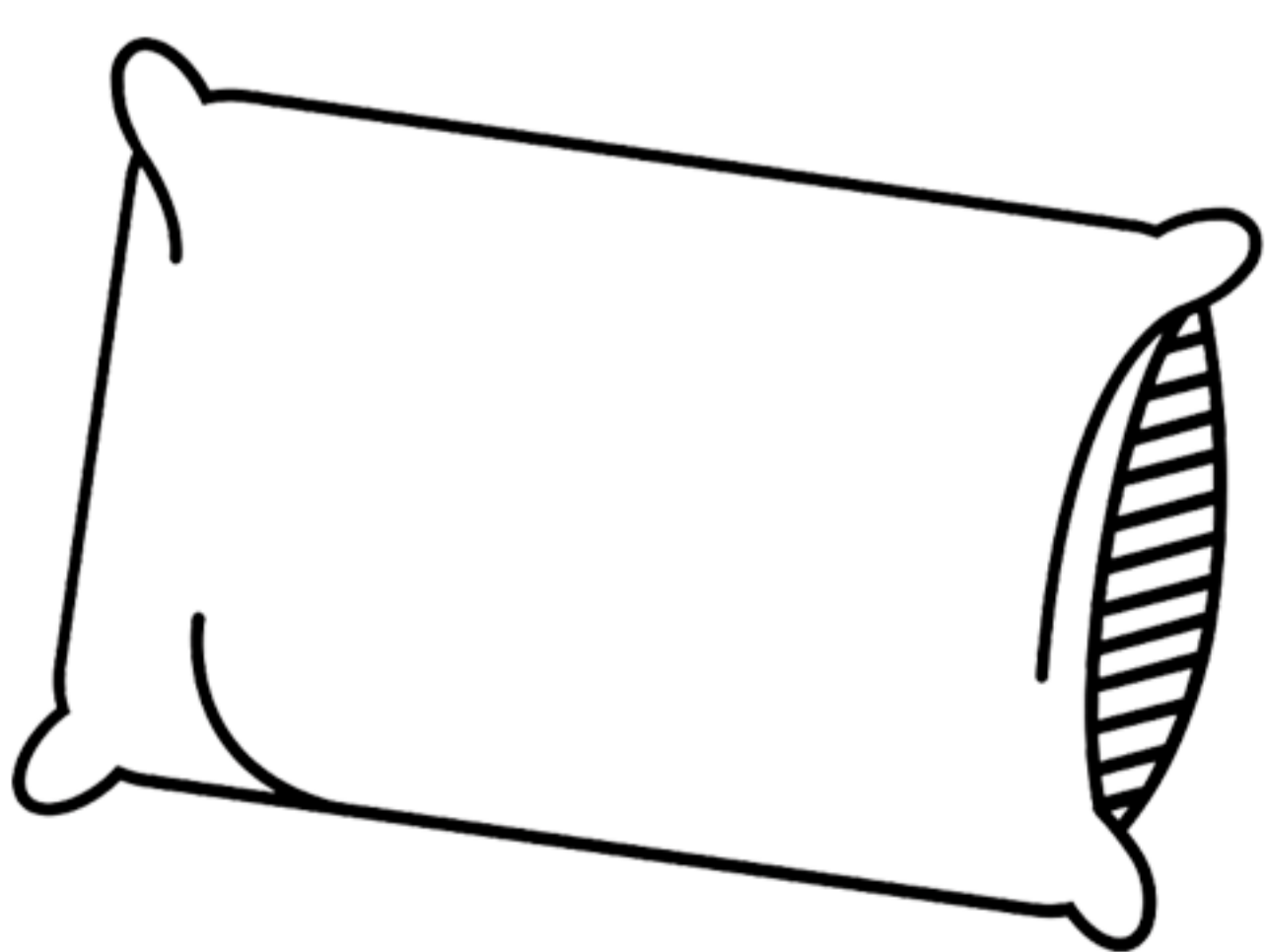

..... scino



..... oco

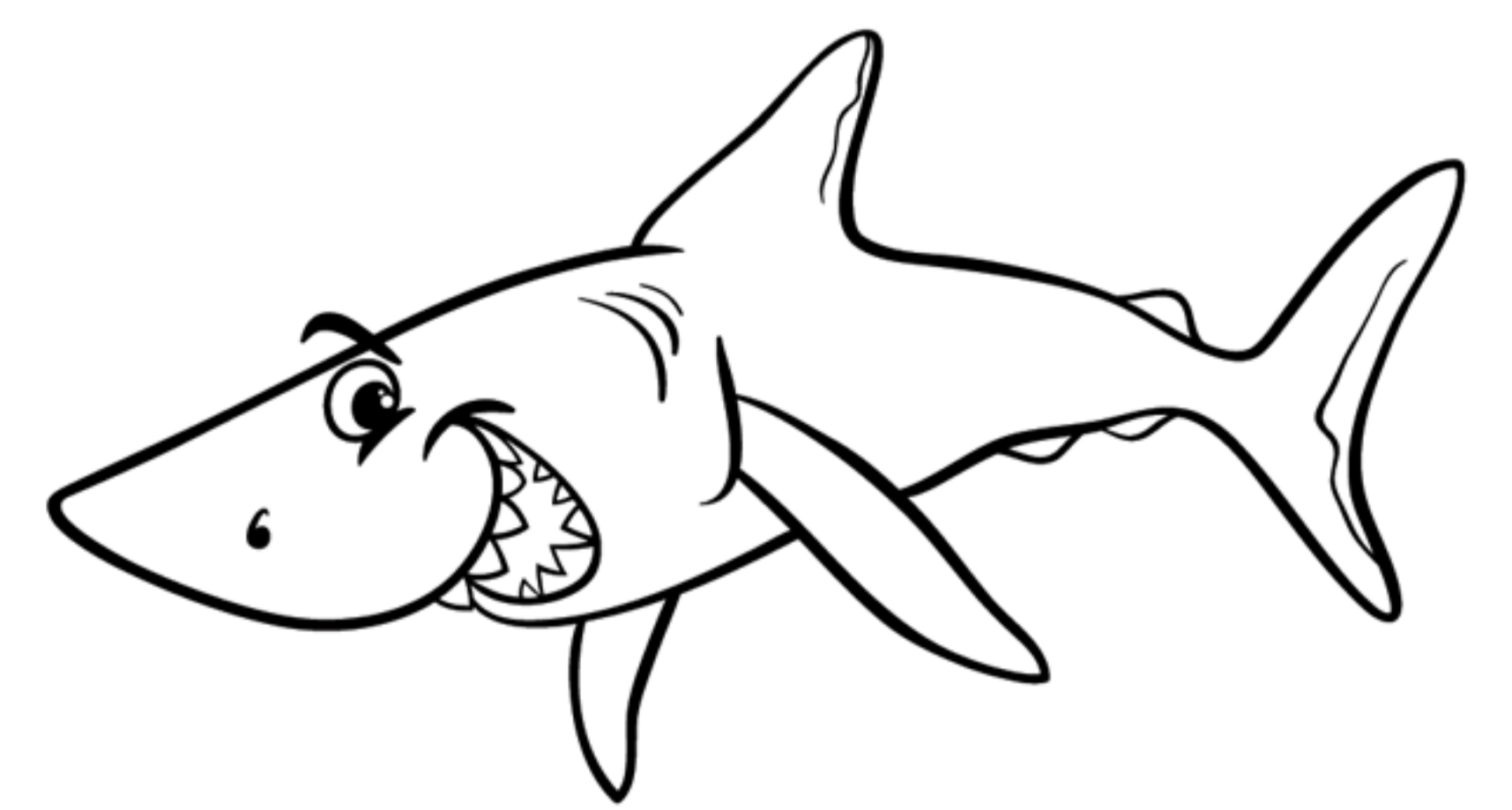

s alo

CU - QU - CQU

- Riscrivi le parole nella giusta tabella.

cuocere - acquolina - quattro - cucina - obliquo

questura - acquitrino - aculeo - squadra - acquedotto

cuccia - evacuare - acquavite - cuffie - sequoia

Questa è una copia
dimostrativa.

Tutti i nostri eBook possono
essere acquistati sul sito.

©Pianetabambini.it

MB - MP

- Osserva i disegni e scrivi le parole nella giusta tabella.

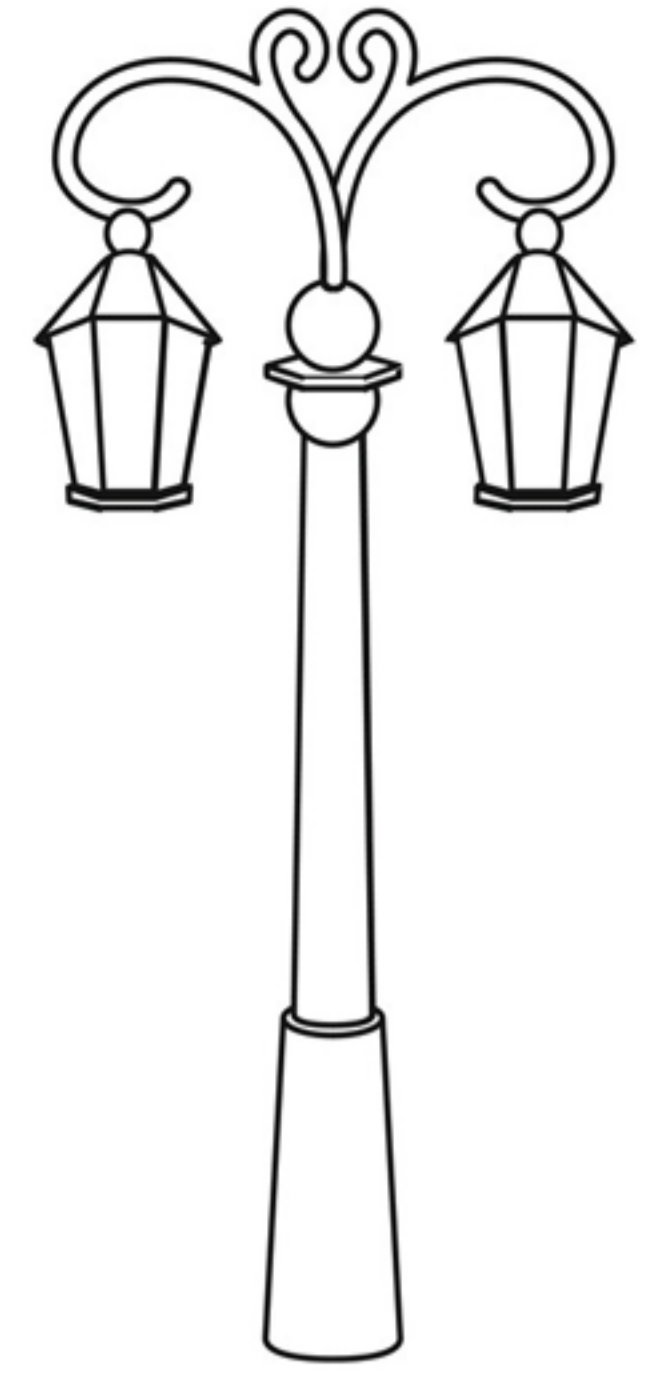
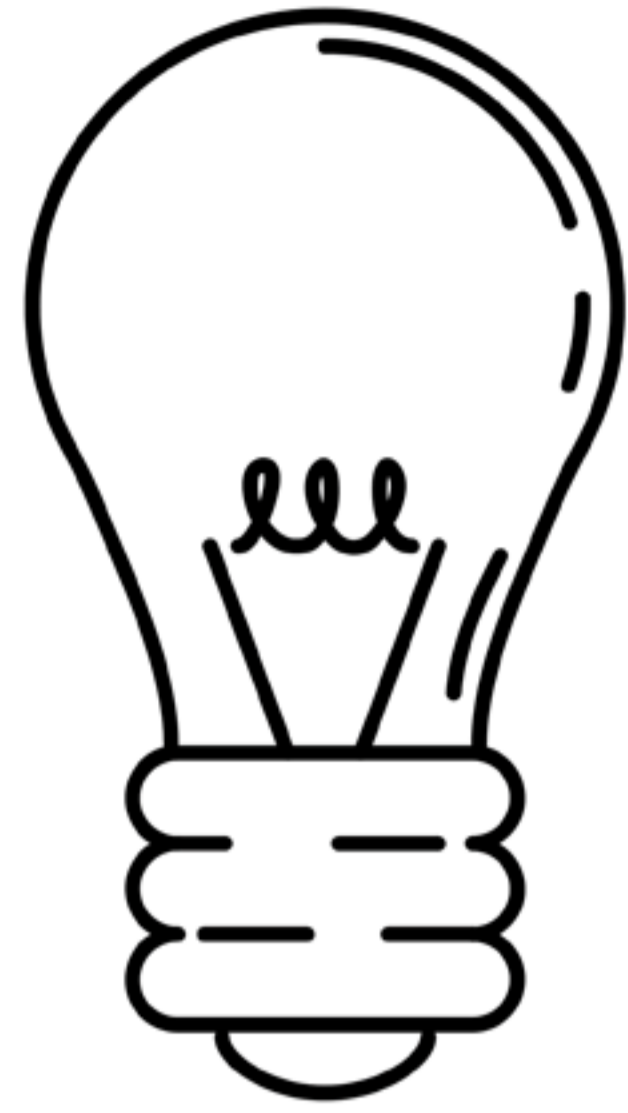

Questa è una copia
dimostrativa.

Tutti i nostri eBook possono
essere acquistati sul sito.

©Pianetabambini.it

MB - MP

- Completa le parole con MB o MP.

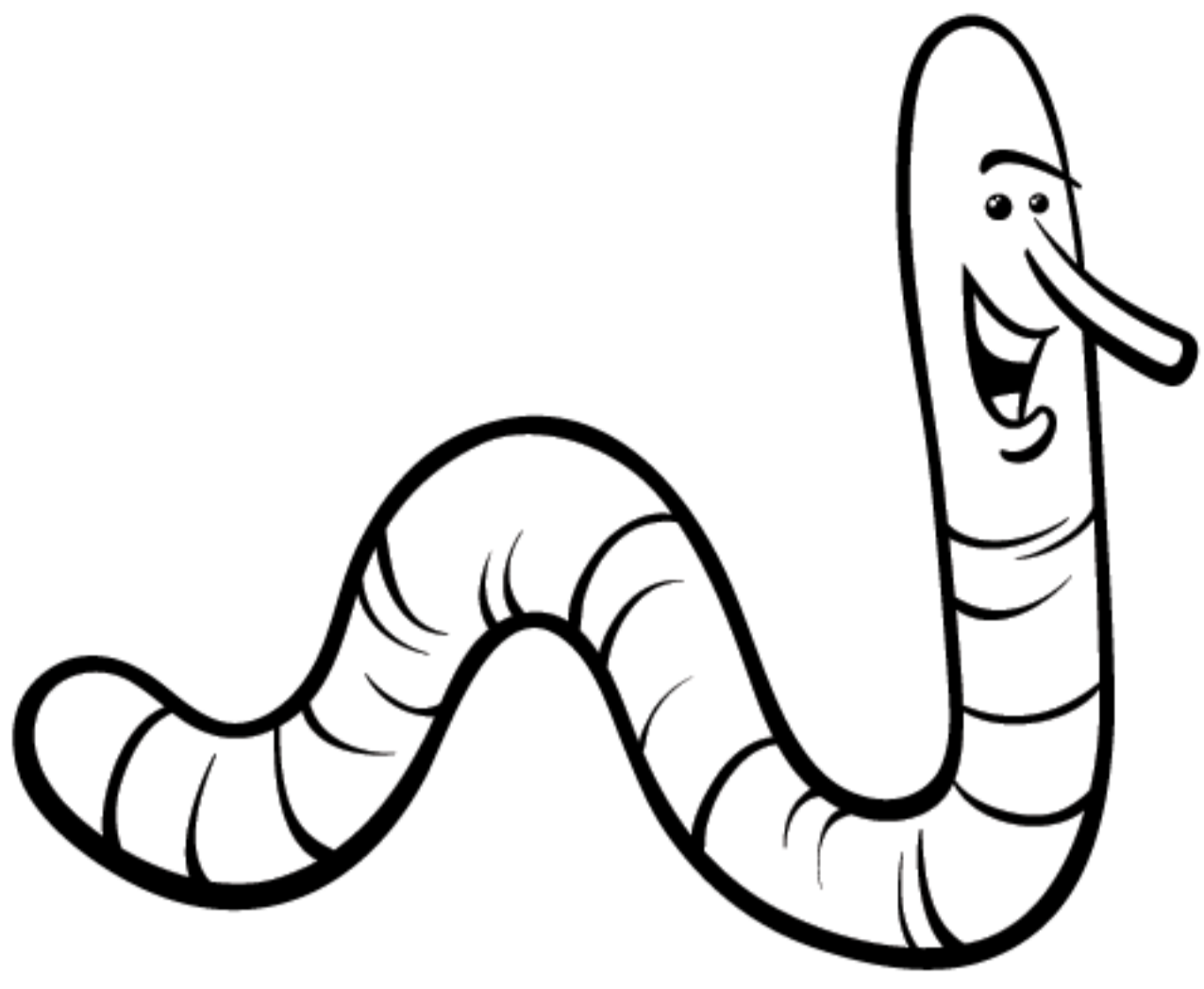

la rica

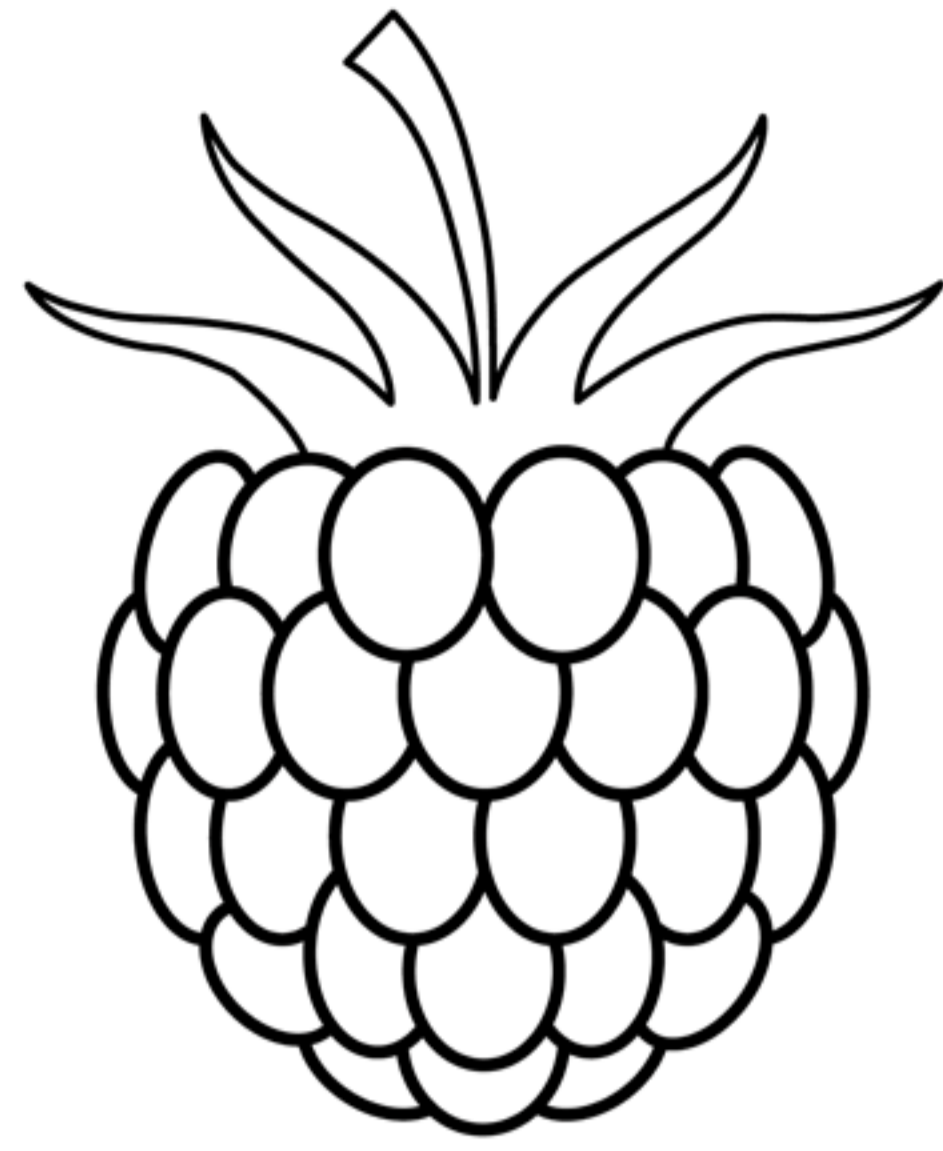

la ano

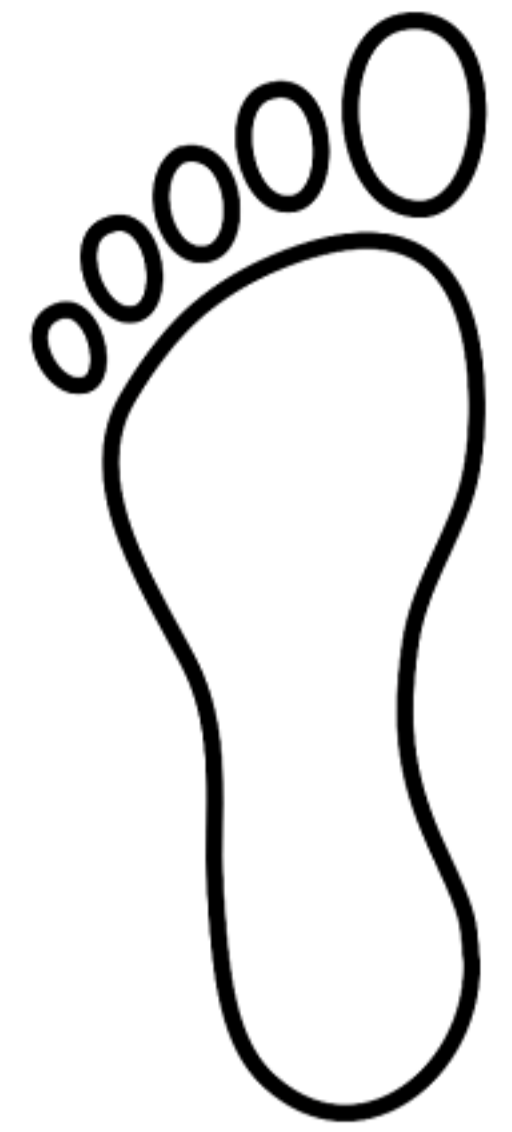

i renta

Questa è una copia
dimostrativa.

Tutti i nostri eBook possono
essere acquistati sul sito.

©Pianetabambini.it

la ada

ba ino

la o

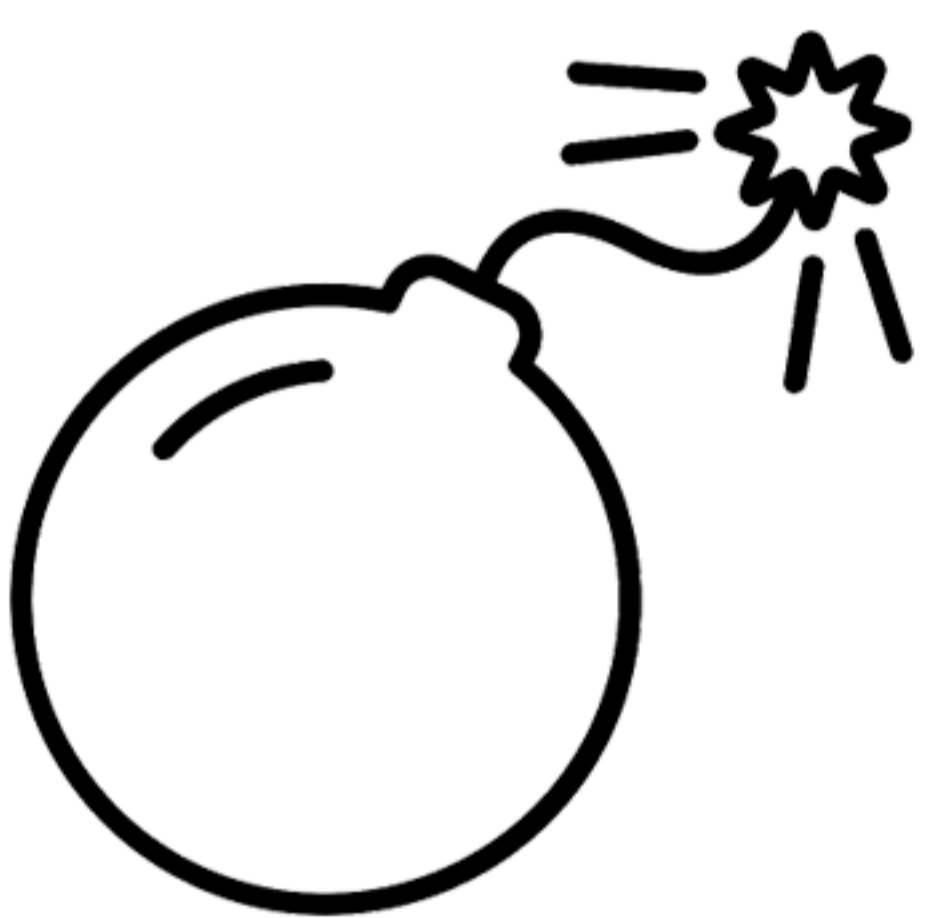

bo a

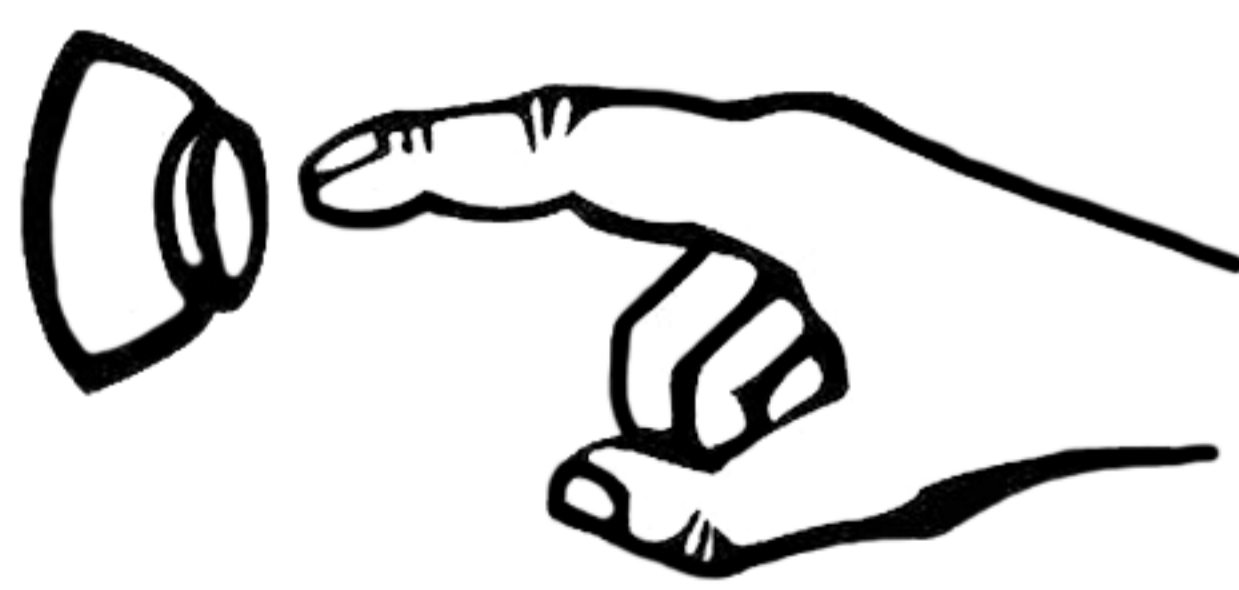

ca anello

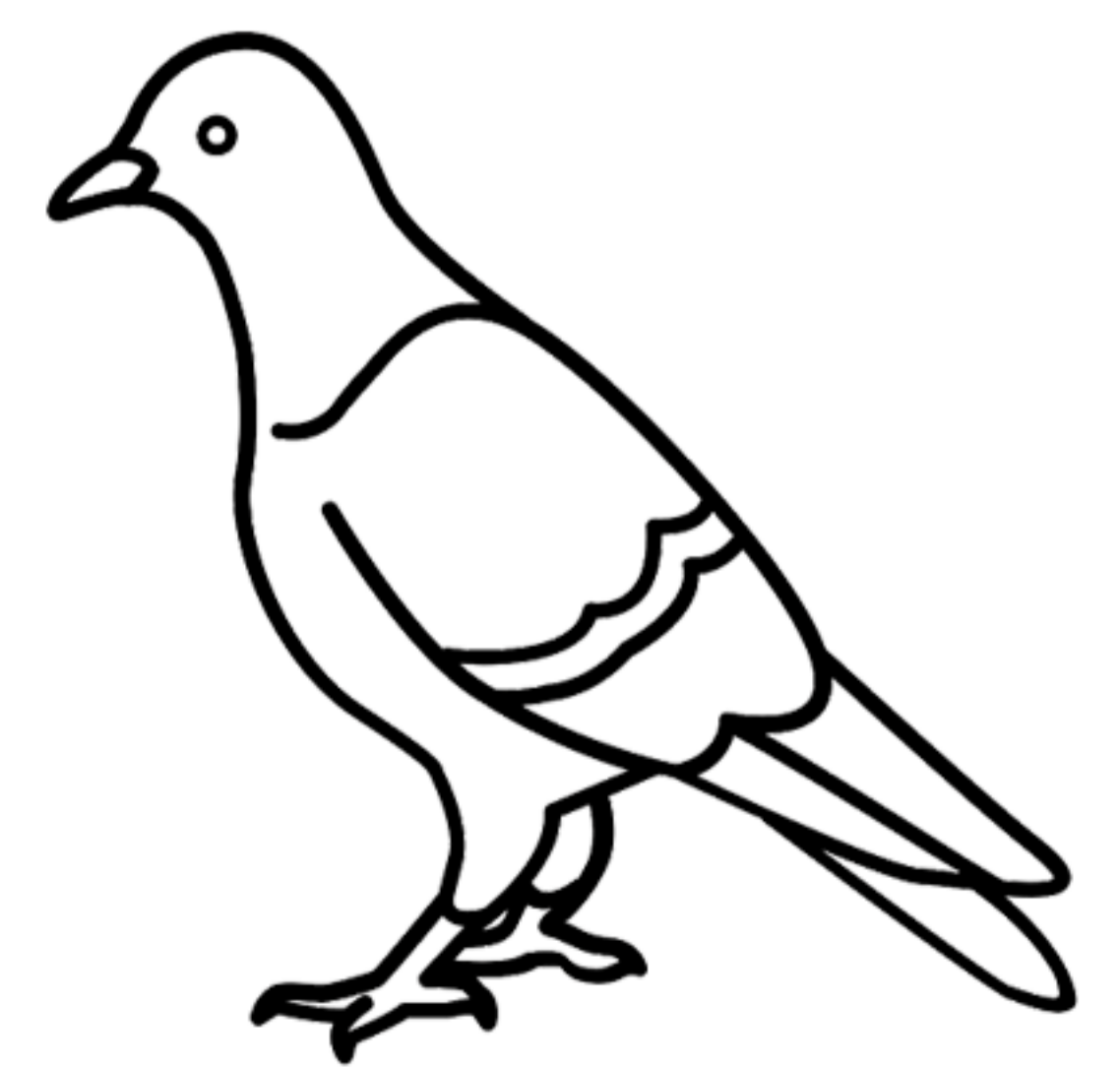

colo o

Suoni difficili

- Completa scegliendo tra br o pr.



om.....ello

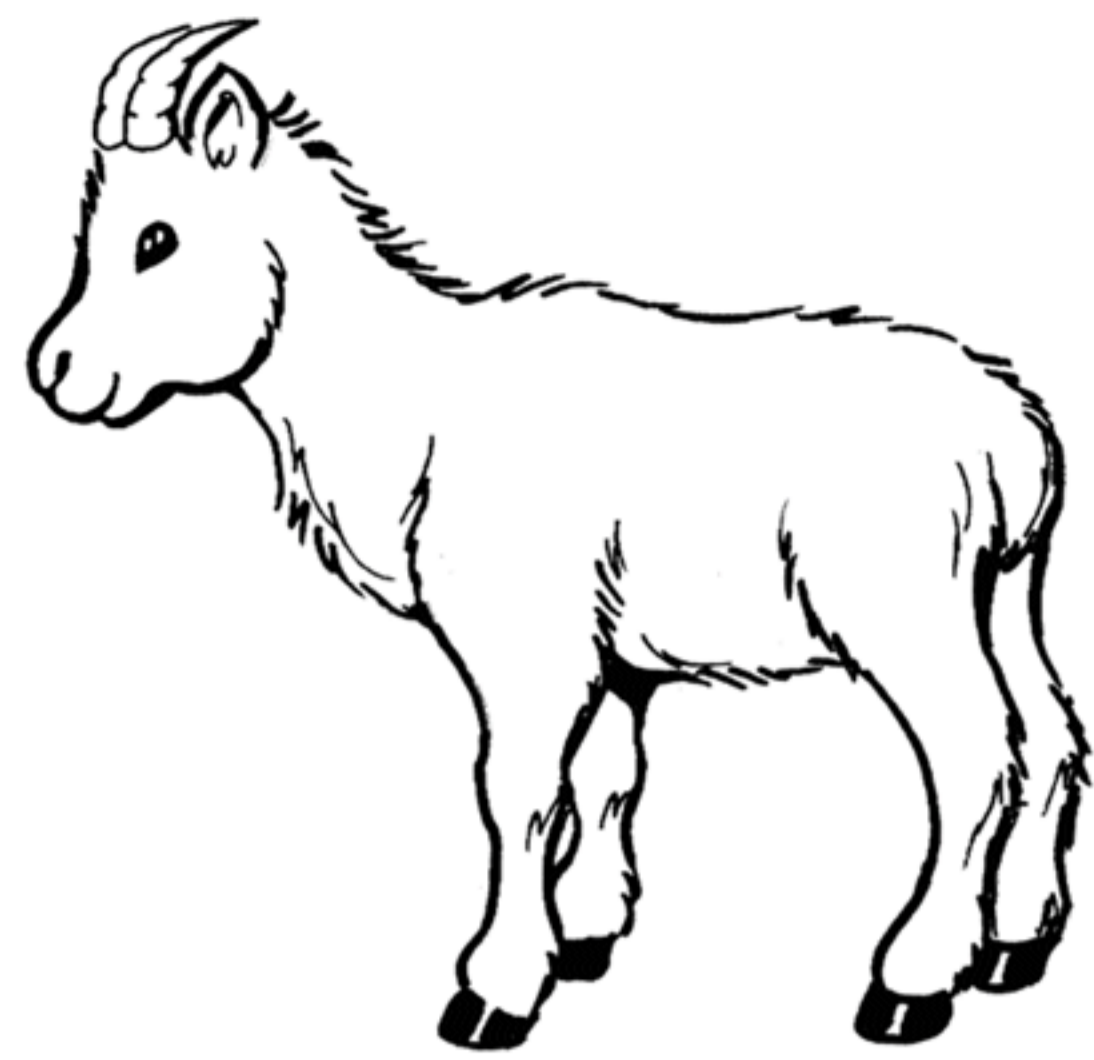

ca.....a



ze.....a



.....ofumo

Questa è una copia dimostrativa.

Tutti i nostri eBook possono essere acquistati sul sito.

©Pianetabambini.it

.....anchio

.....iceto

.....illo

.....avatta

- Completa scegliendo tra fr o vr.

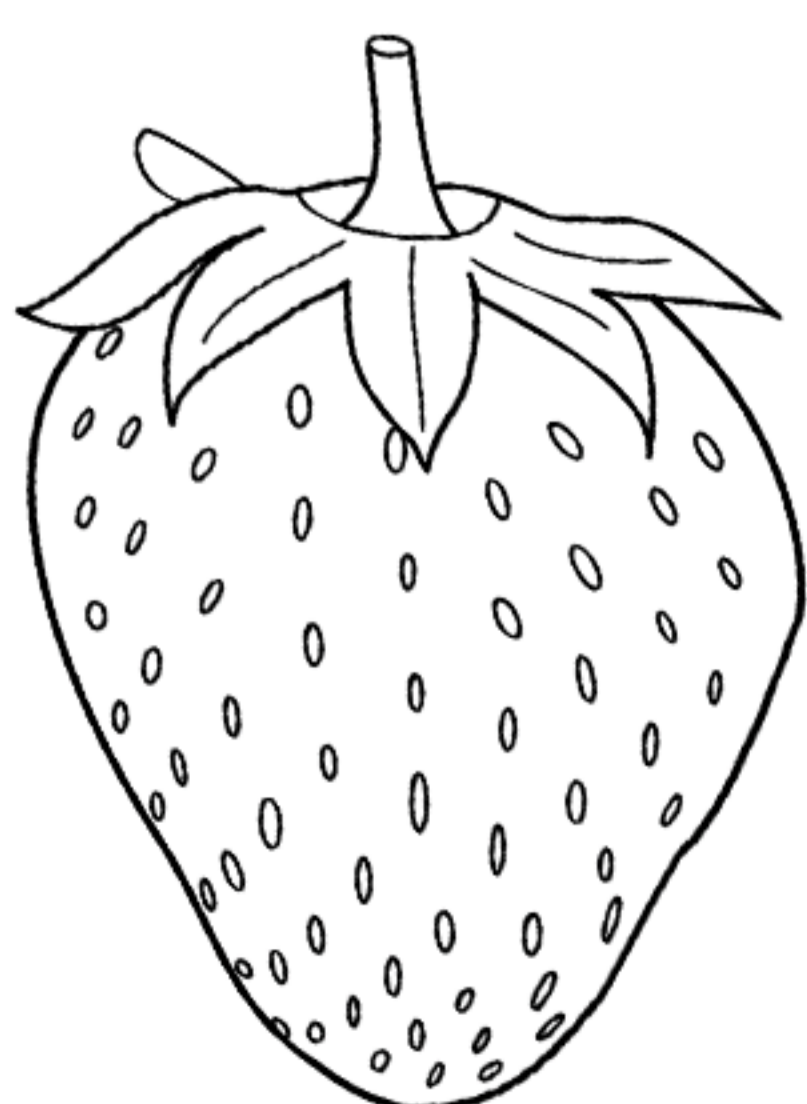

.....agola



.....ullatore

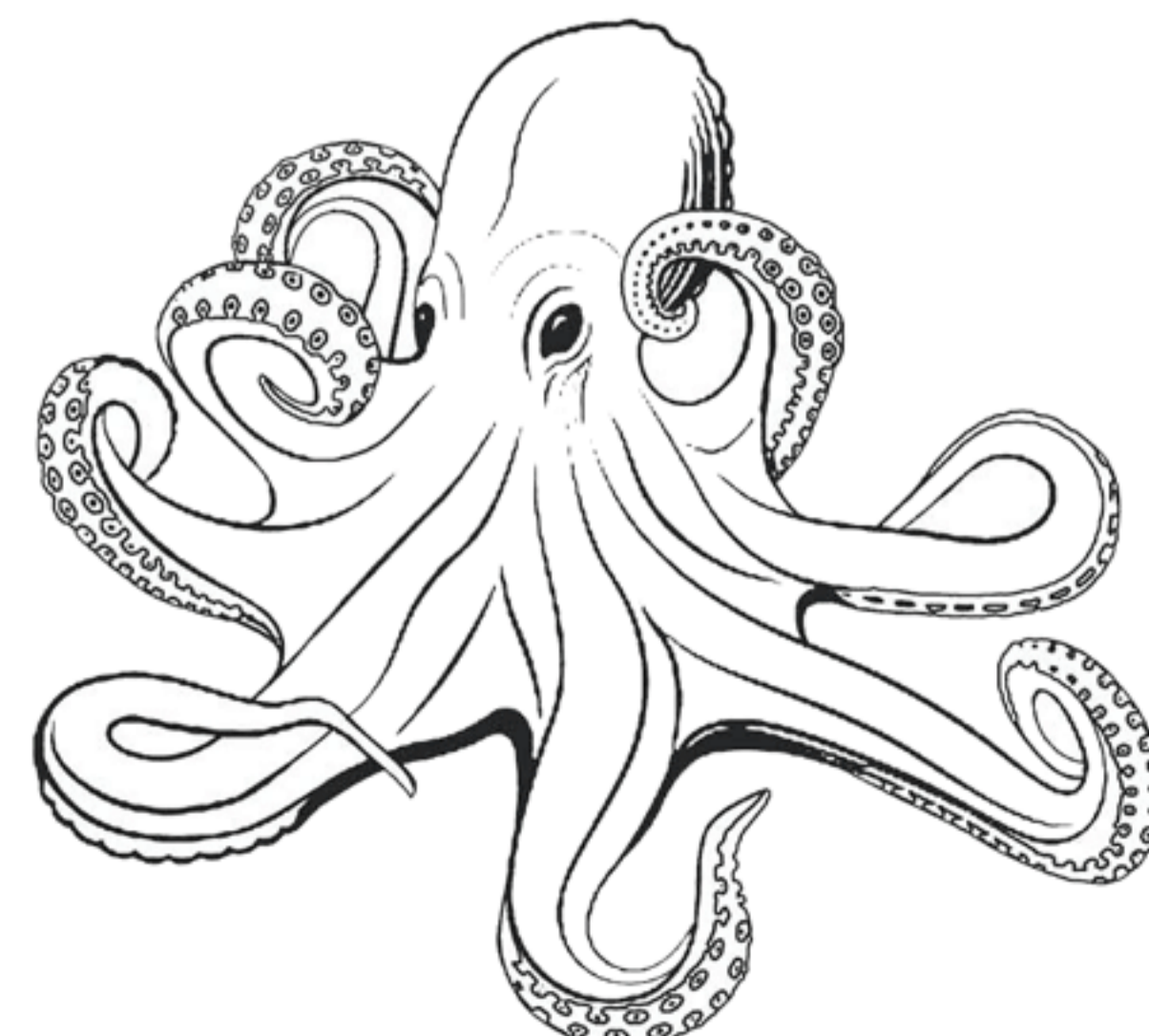

pio.....a

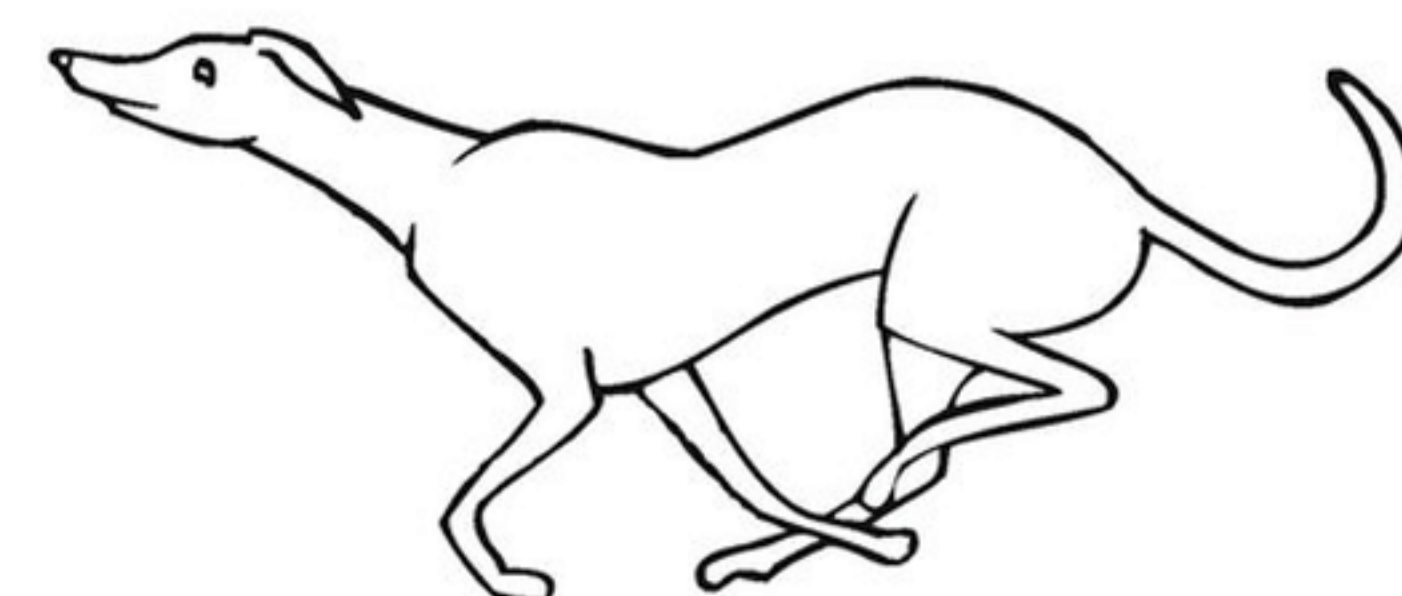

le.....iero

Suoni difficili

- Riordina le sillabe e riscrivi le parole.

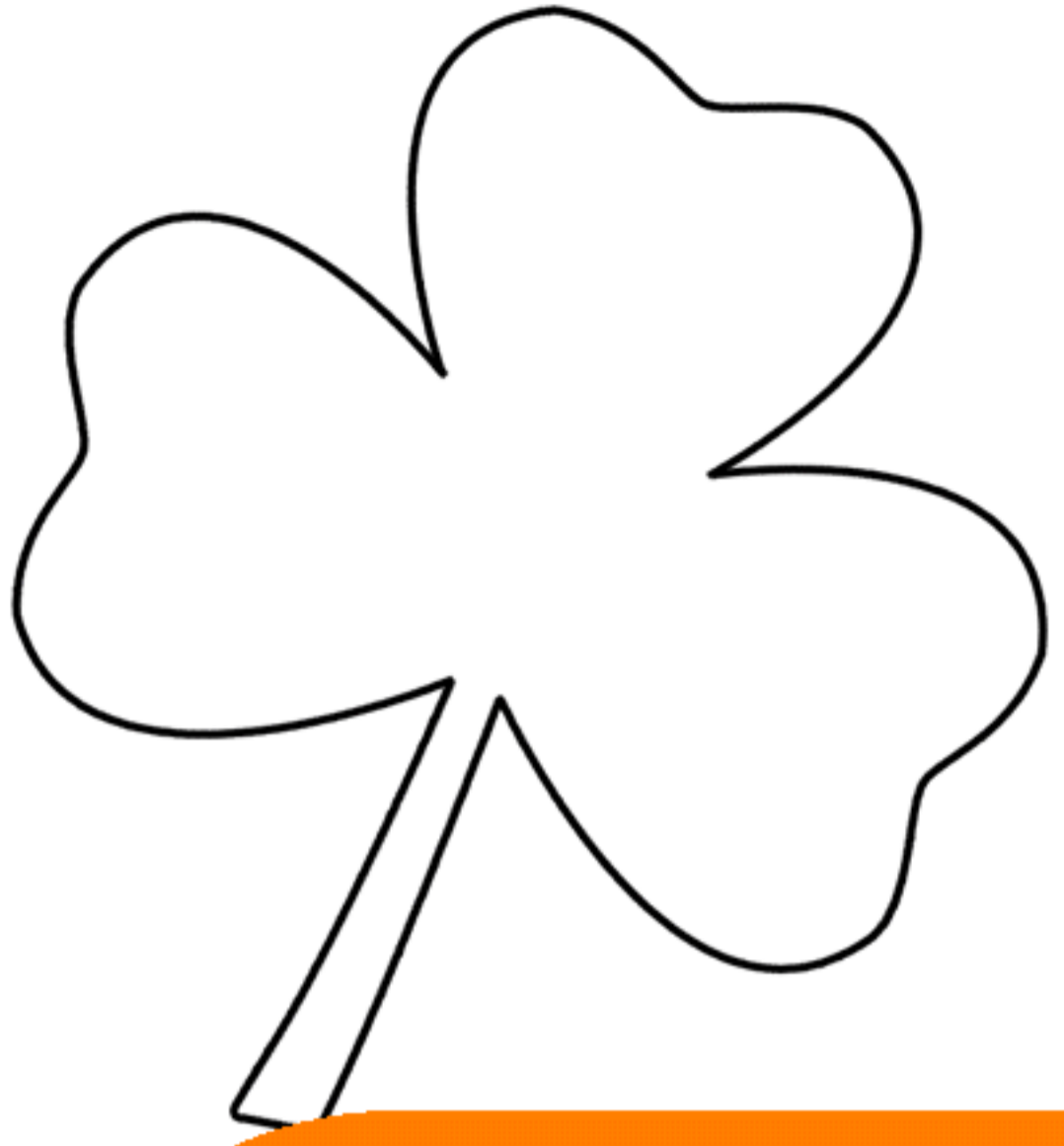

glio fo tri

.....

Questa è una copia
dimostrativa.

Tutti i nostri eBook possono
essere acquistati sul sito.

©Pianetabambini.it



ze mo prez lo

.....

Suoni difficili

- Completa le parole con sbr, scr, sdr, sfr, sgr, spr, str.

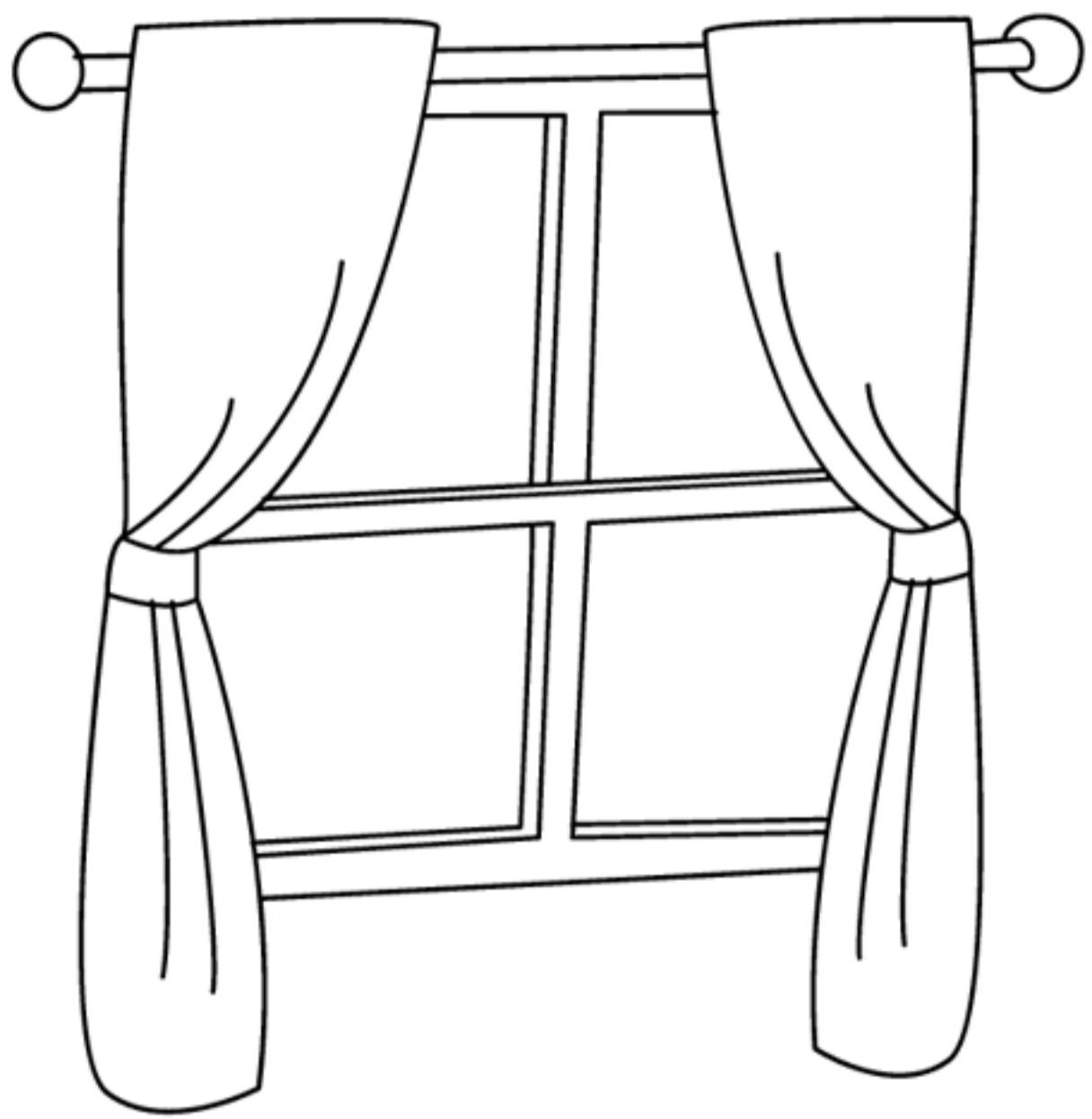

Questa è una copia
dimostrativa.

Tutti i nostri eBook possono
essere acquistati sul sito.

©Pianetabambini.it

..... ofnaccio

mo.....i

..... igno



..... ada



mano itto

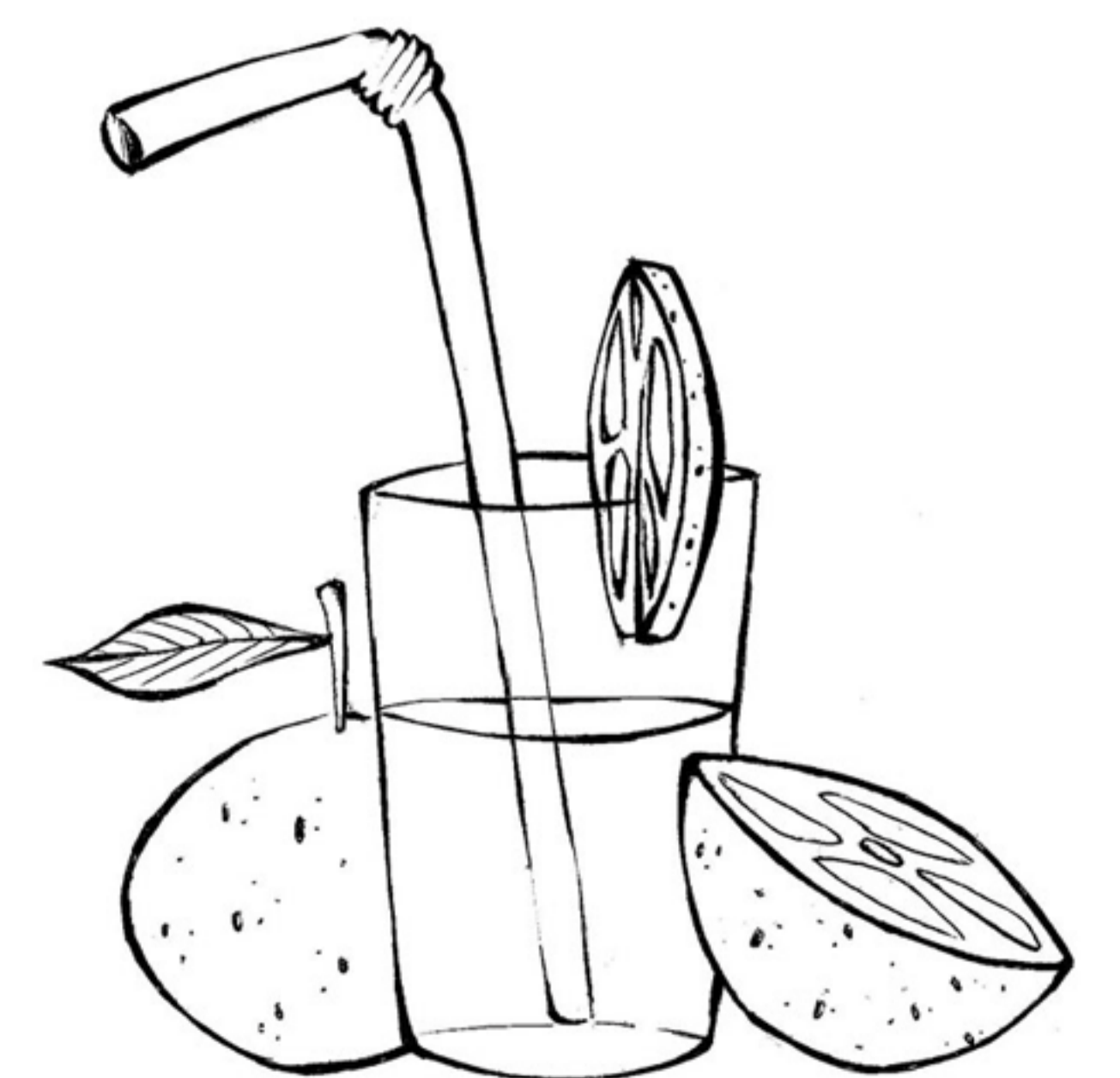

..... emuta

Lettere ponte L M N R

- Osserva i disegni e scrivi la lettera che fa da ponte.

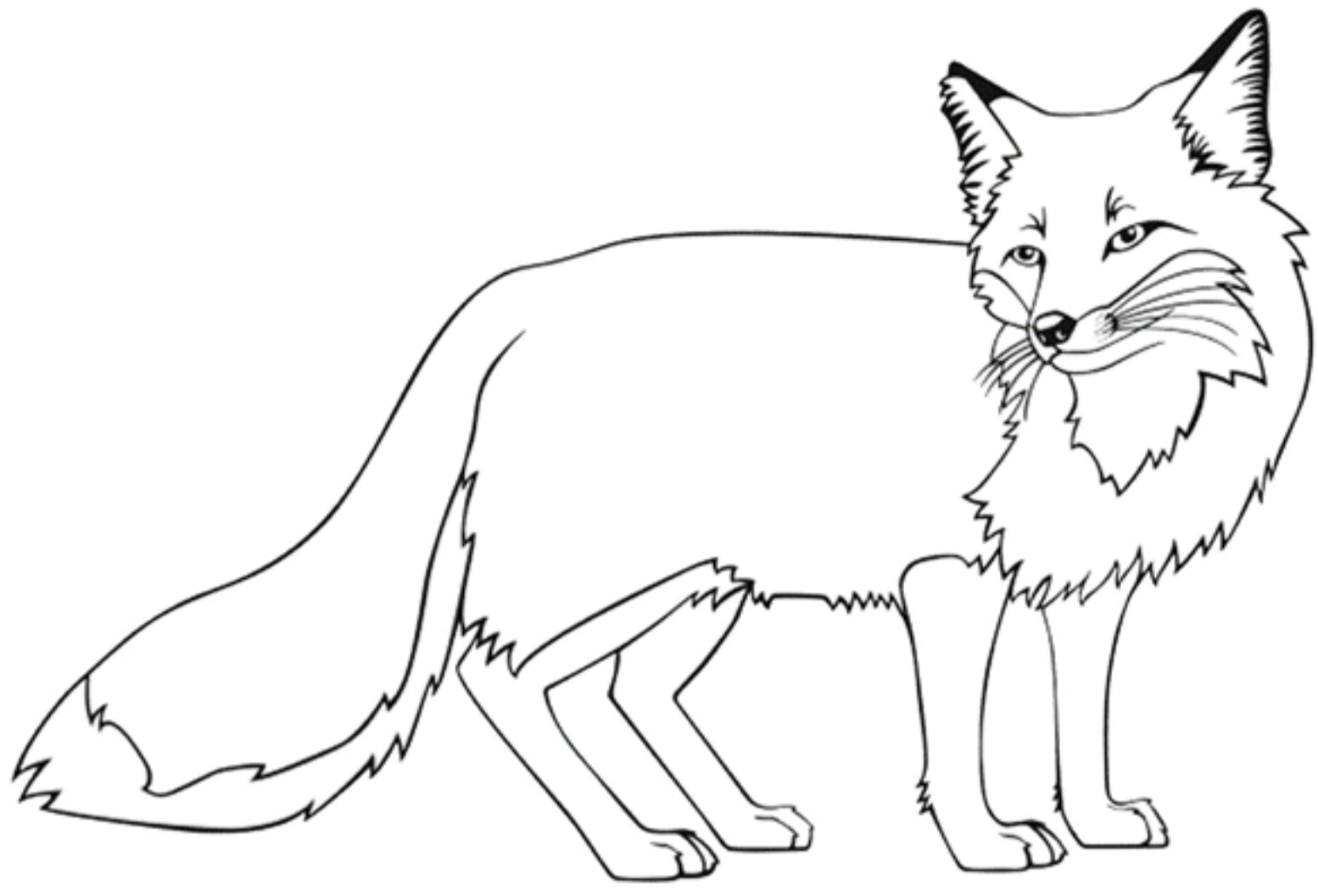

vo ne



fe na

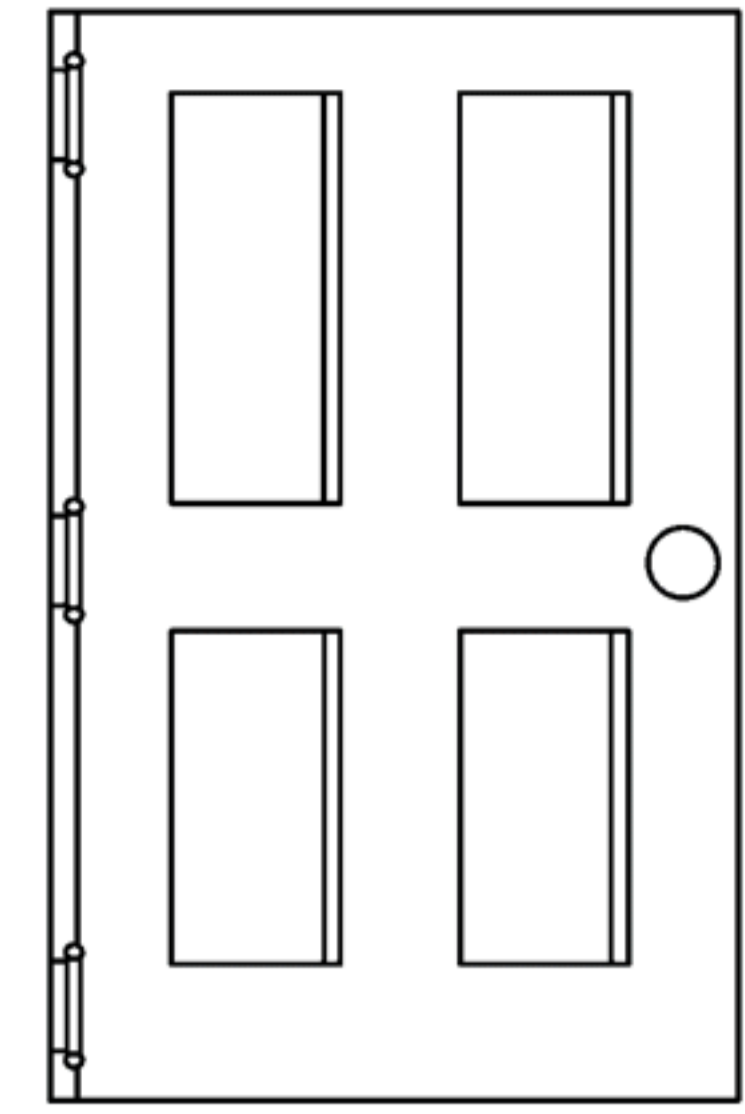

no ta

Questa è una copia
dimostrativa.

Tutti i nostri eBook possono
essere acquistati sul sito.

©Pianetabambini.it

te ... po

po ... te

ba ... ca

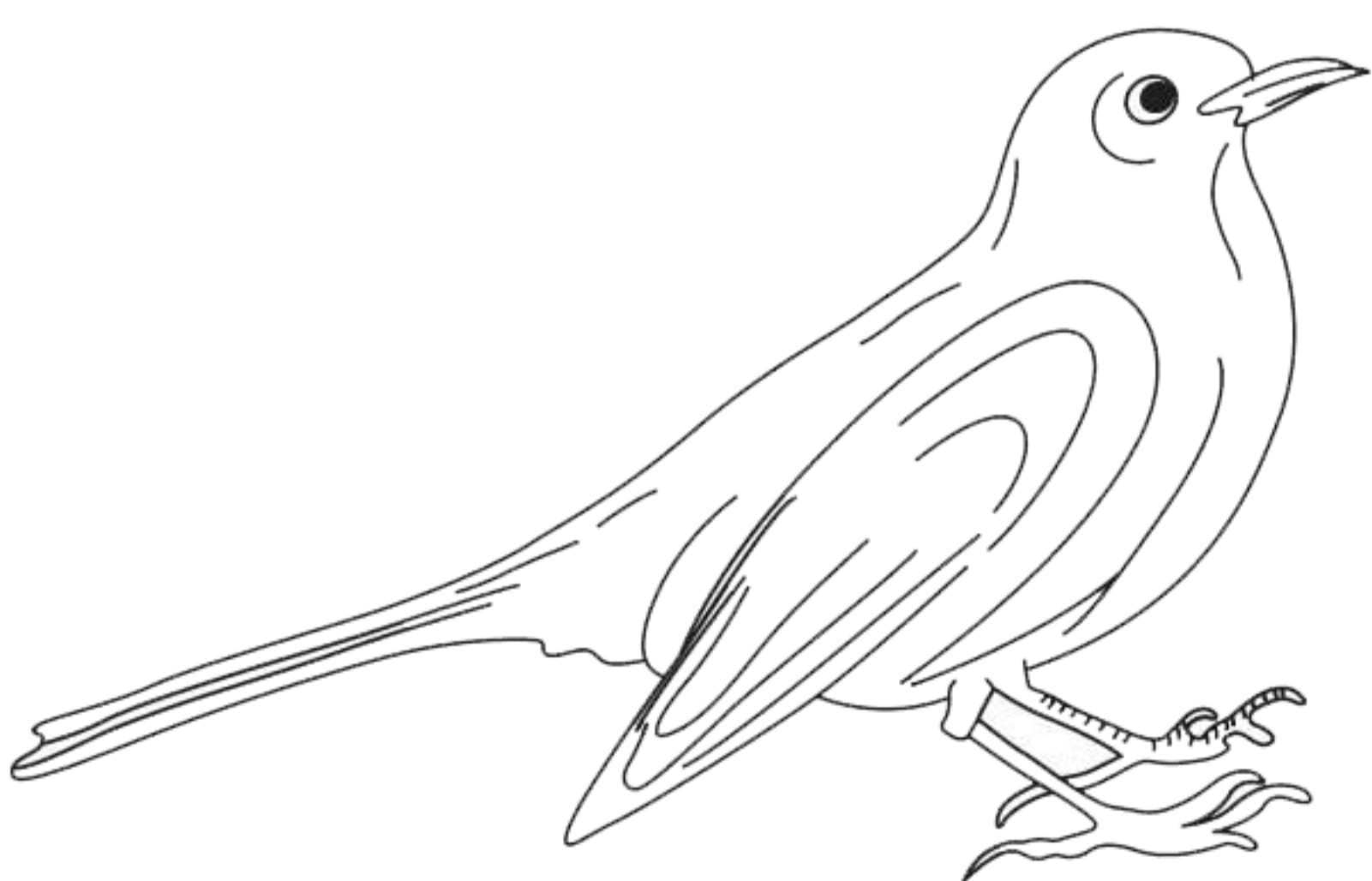

me ... lo



la ... po



pa ... ma

Lettere ponte L M N R

- Osserva i disegni e scrivi la lettera che manca.

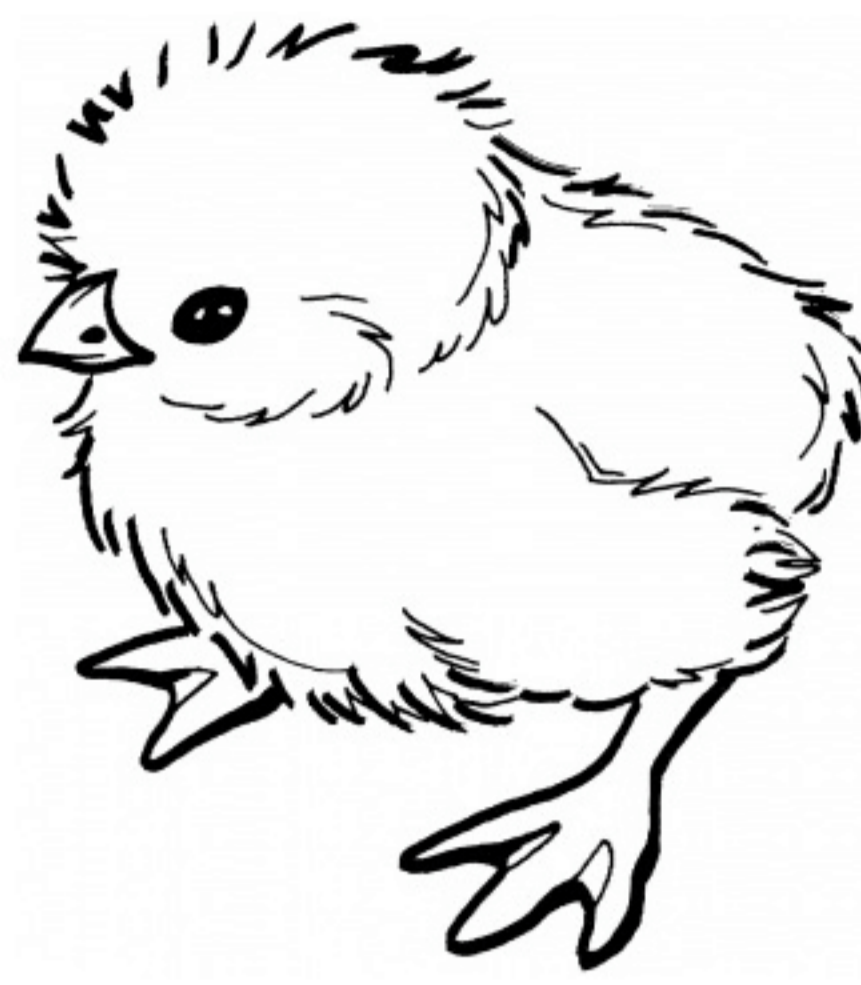
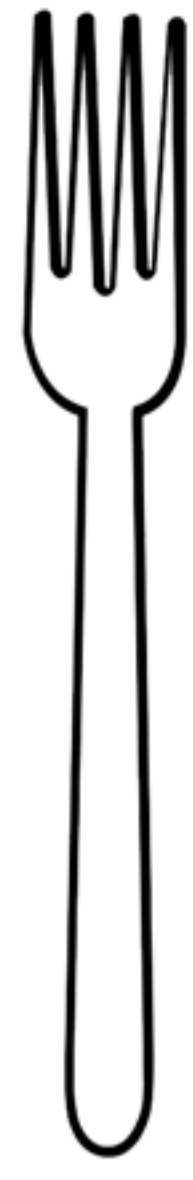

Questa è una copia
dimostrativa.

Tutti i nostri eBook possono
essere acquistati sul sito.

©Pianetabambini.it

fisa . . . monica

pe . . . tola

la . . . piona

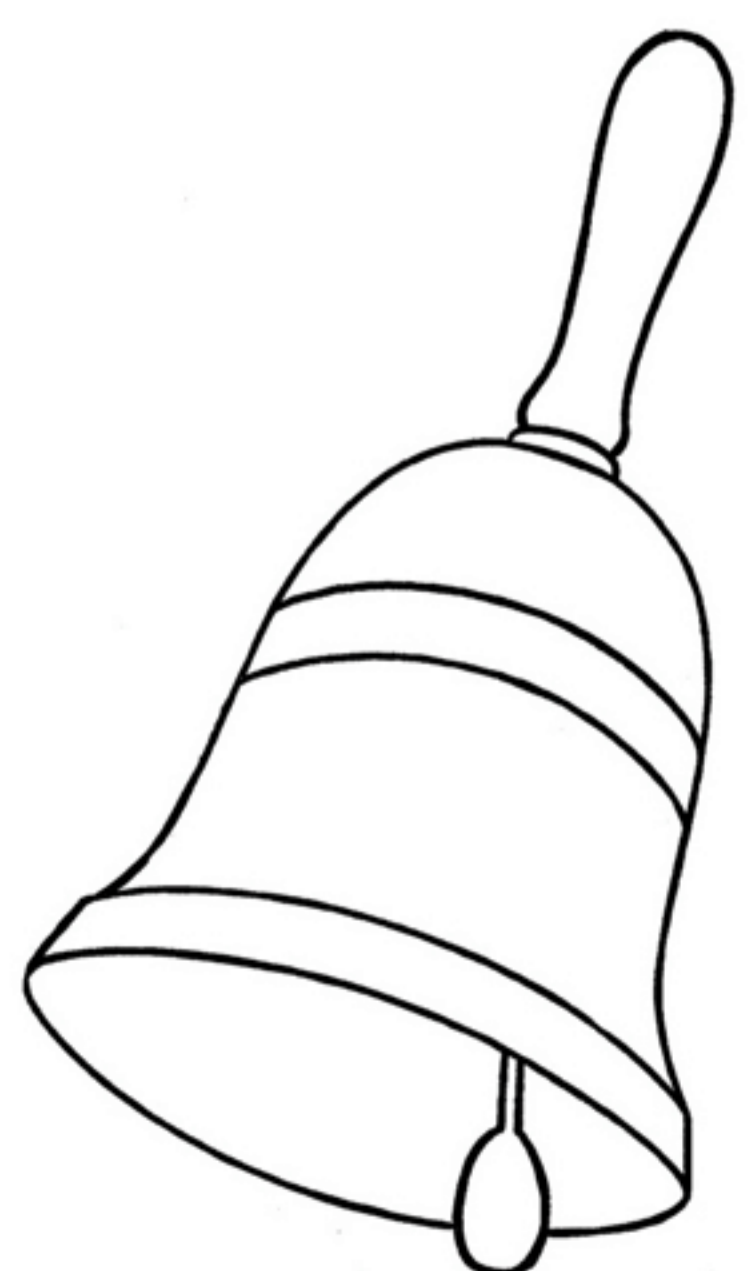

ca . . . pana

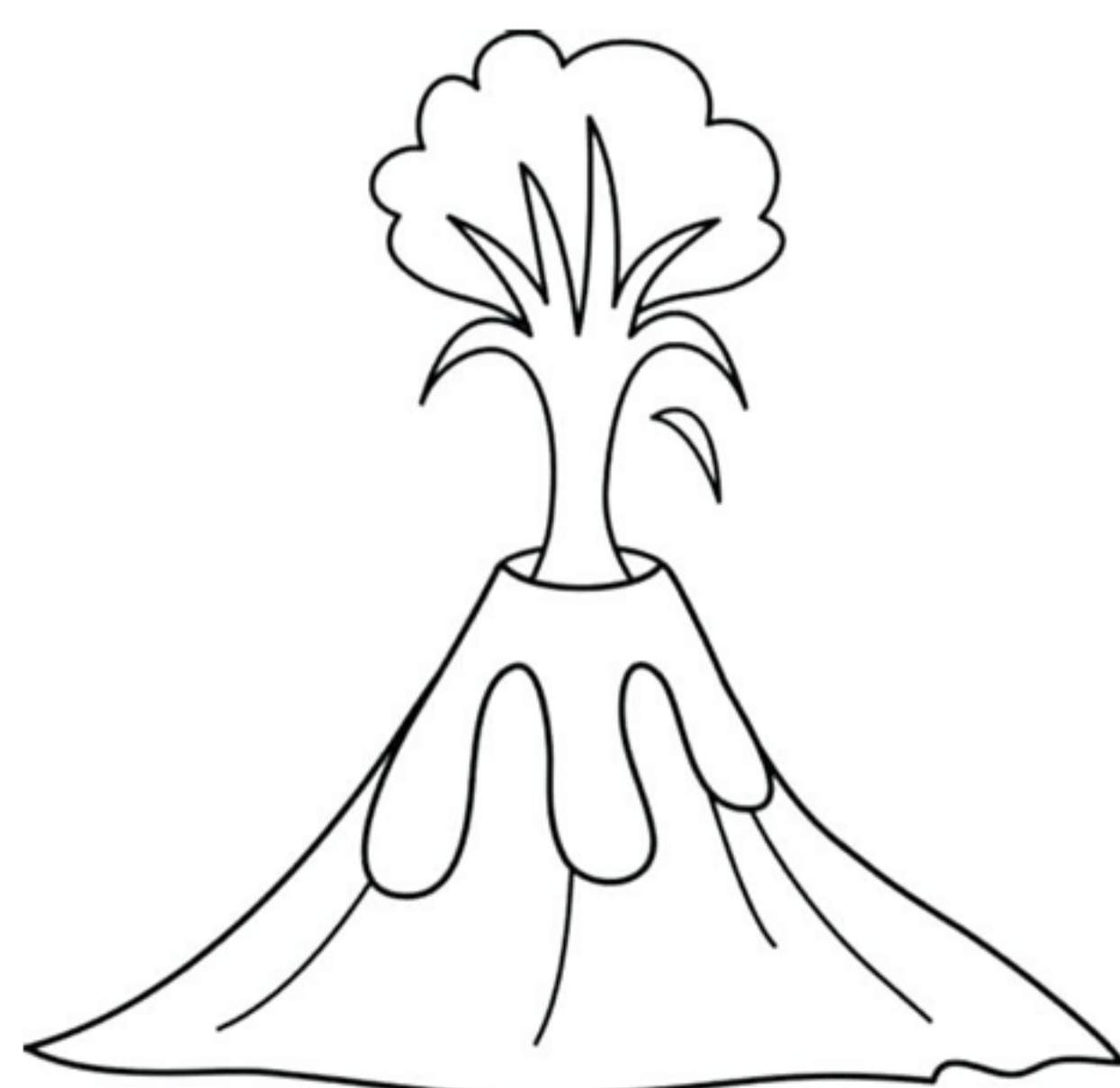

vu . . . cano



fa . . . tasma

Lettere ponte L M N R

- Osserva i disegni e scrivi il loro nome.

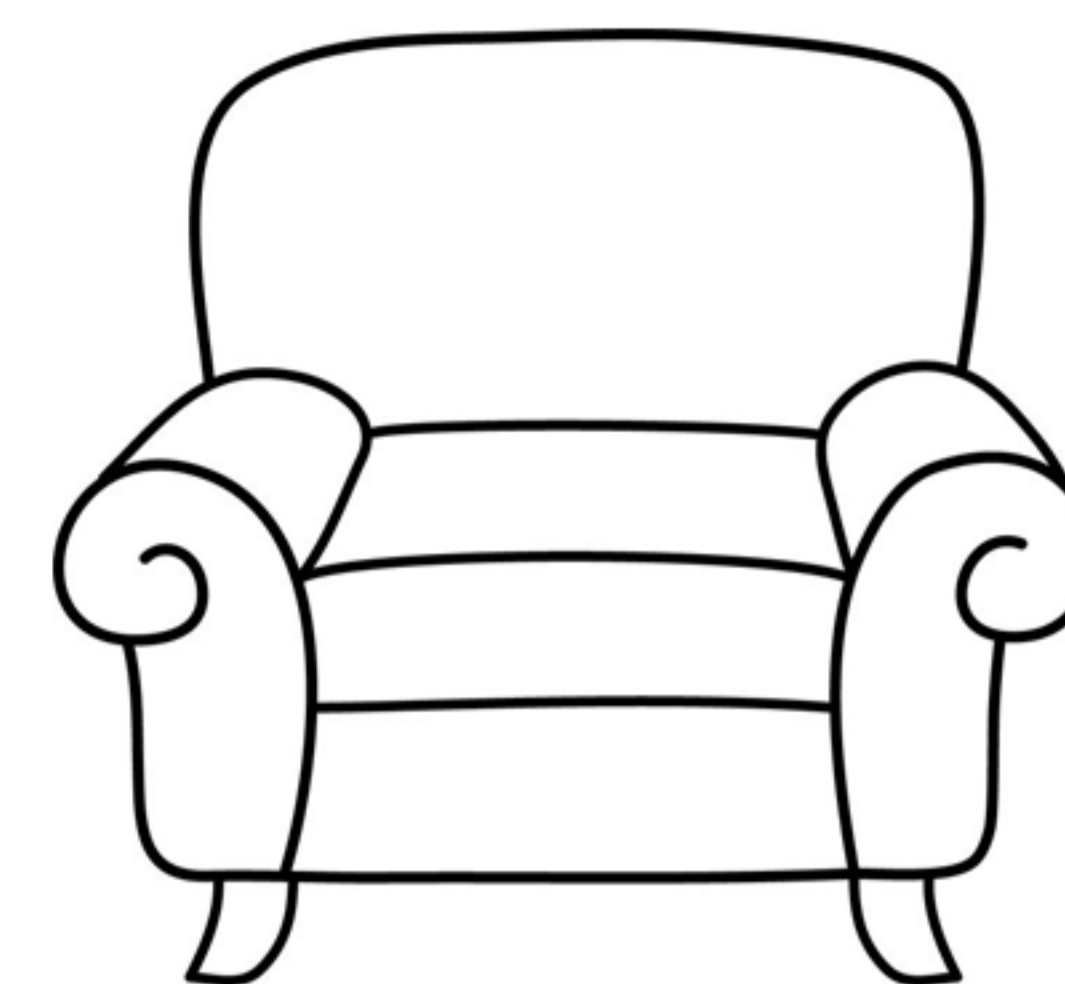
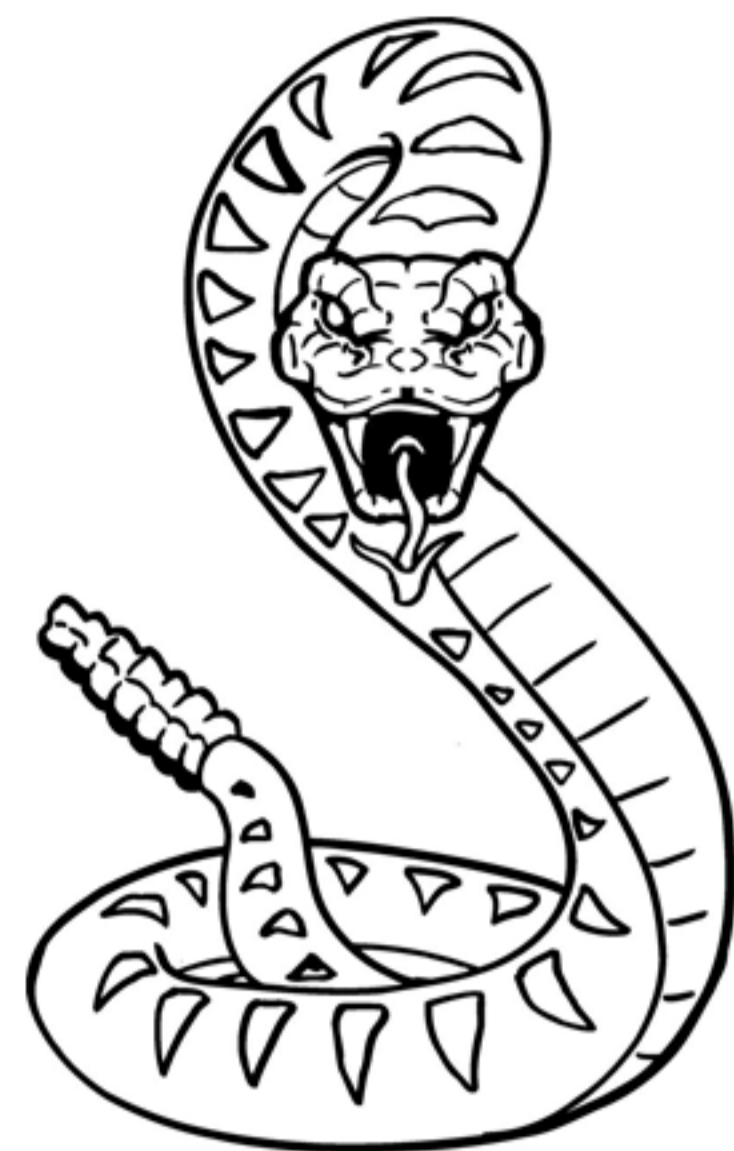

Questa è una copia
dimostrativa.

Tutti i nostri eBook possono
essere acquistati sul sito.

©Pianetabambini.it

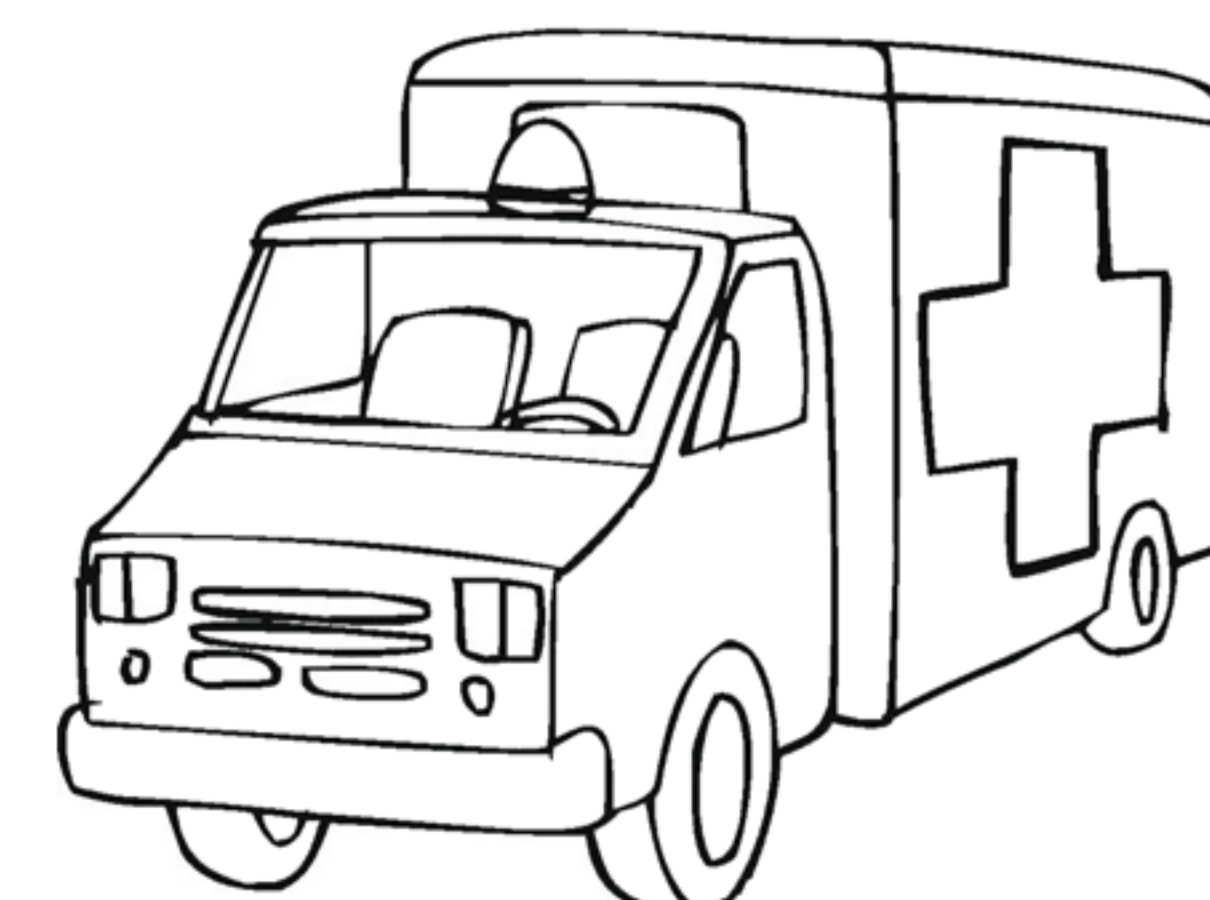
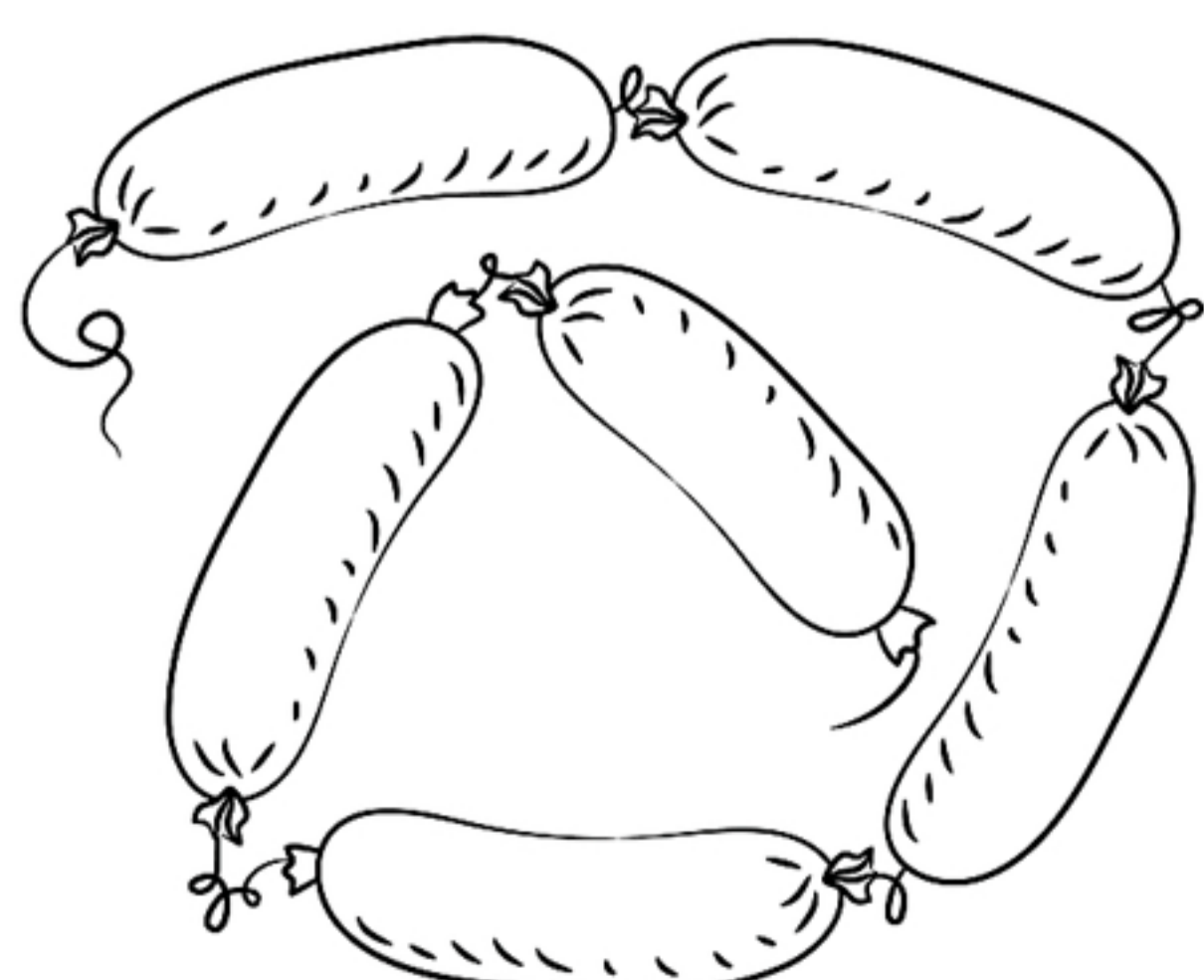

Lettere straniere J K W X Y

- Collega ogni disegno alla sua iniziale.



j

Questa è una copia
dimostrativa.

Tutti i nostri eBook possono
essere acquistati sul sito.

©Pianetabambini.it

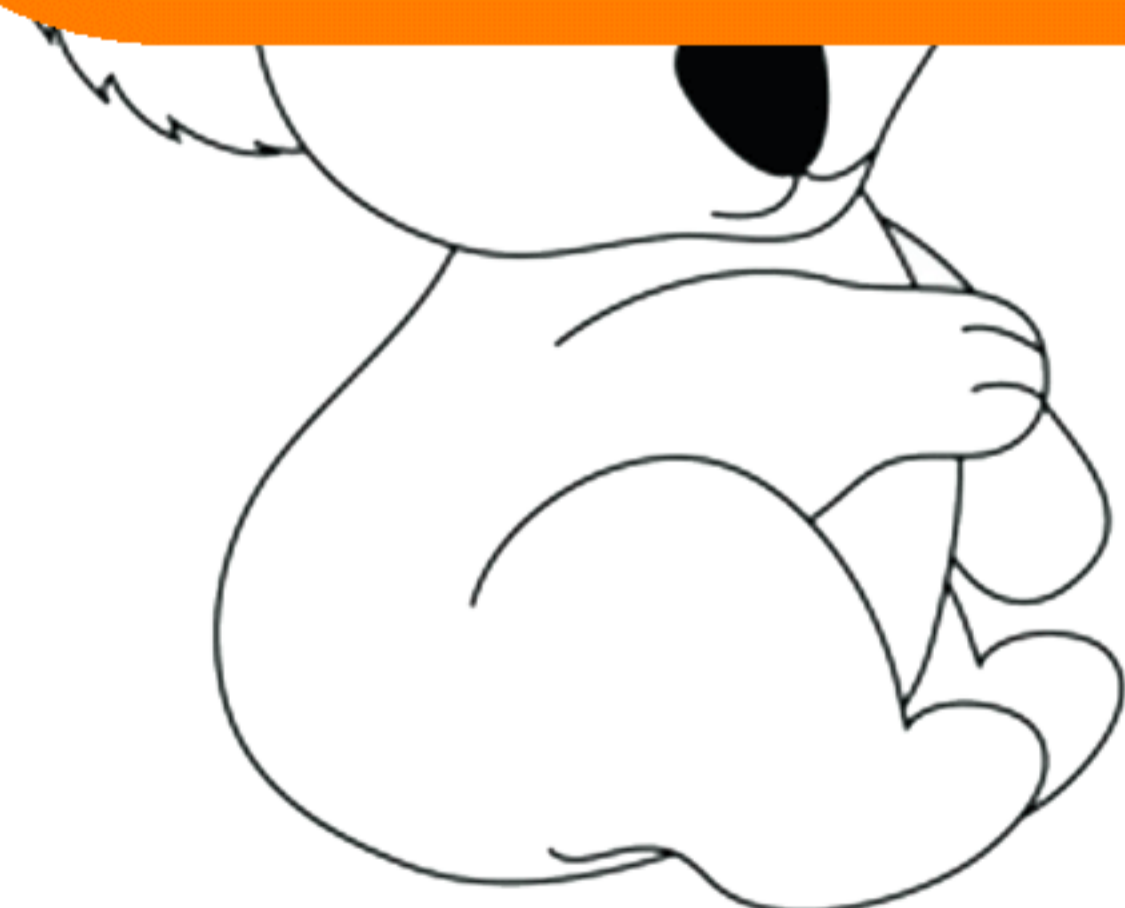

x

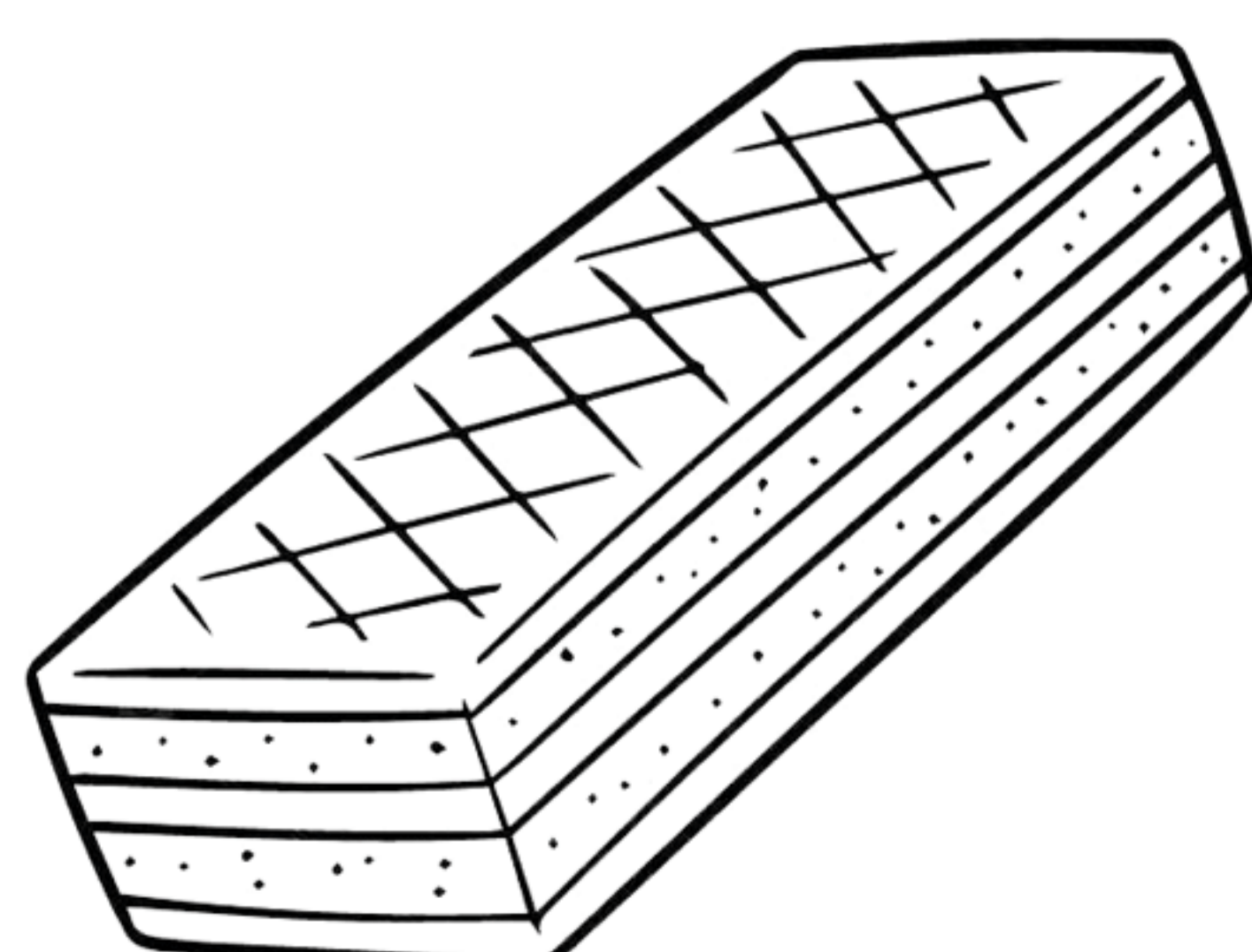

y

Lettere straniere J K W X Y

- Completa le parole con le giuste lettere.

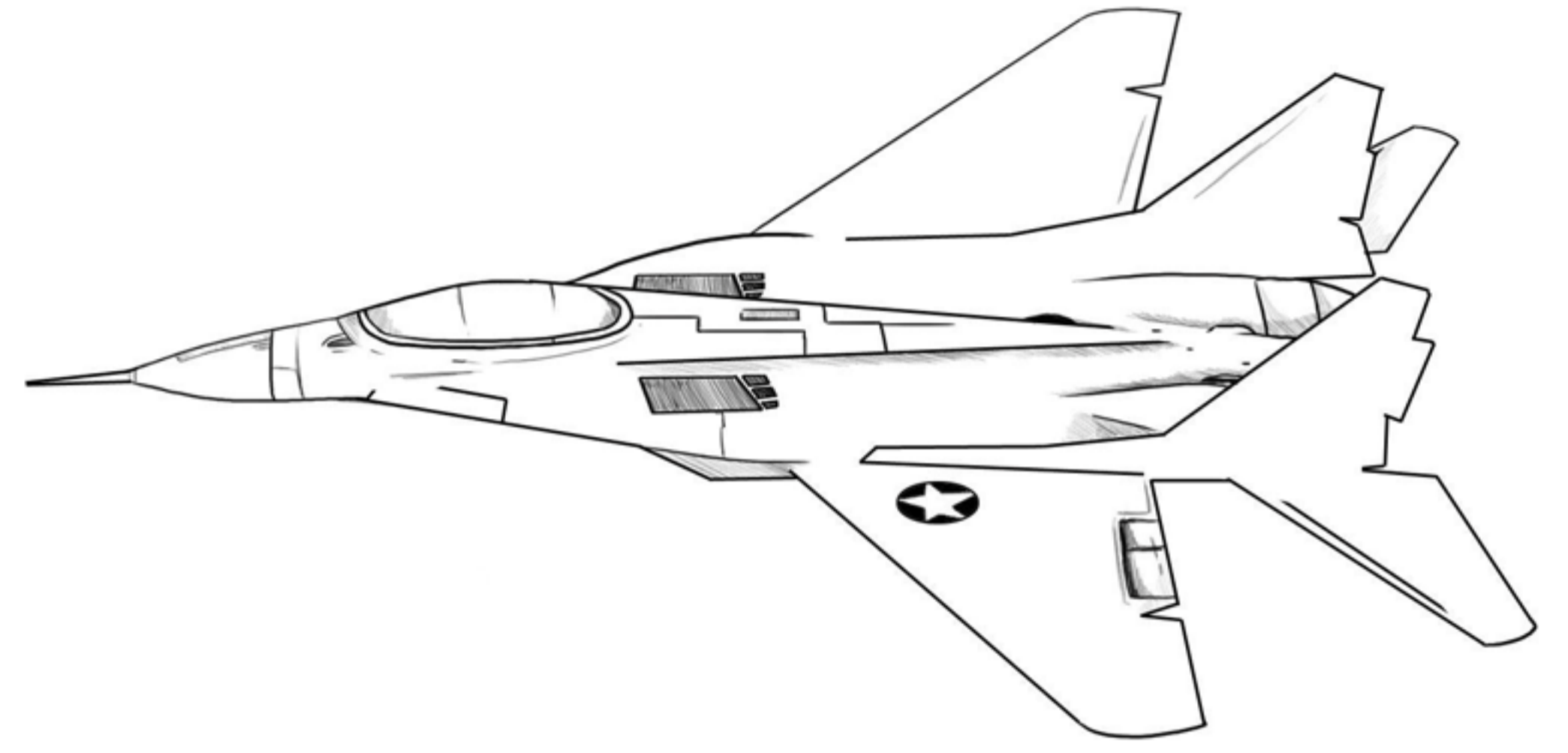

Questa è una copia
dimostrativa.

Tutti i nostri eBook possono
essere acquistati sul sito.

©Pianetabambini.it

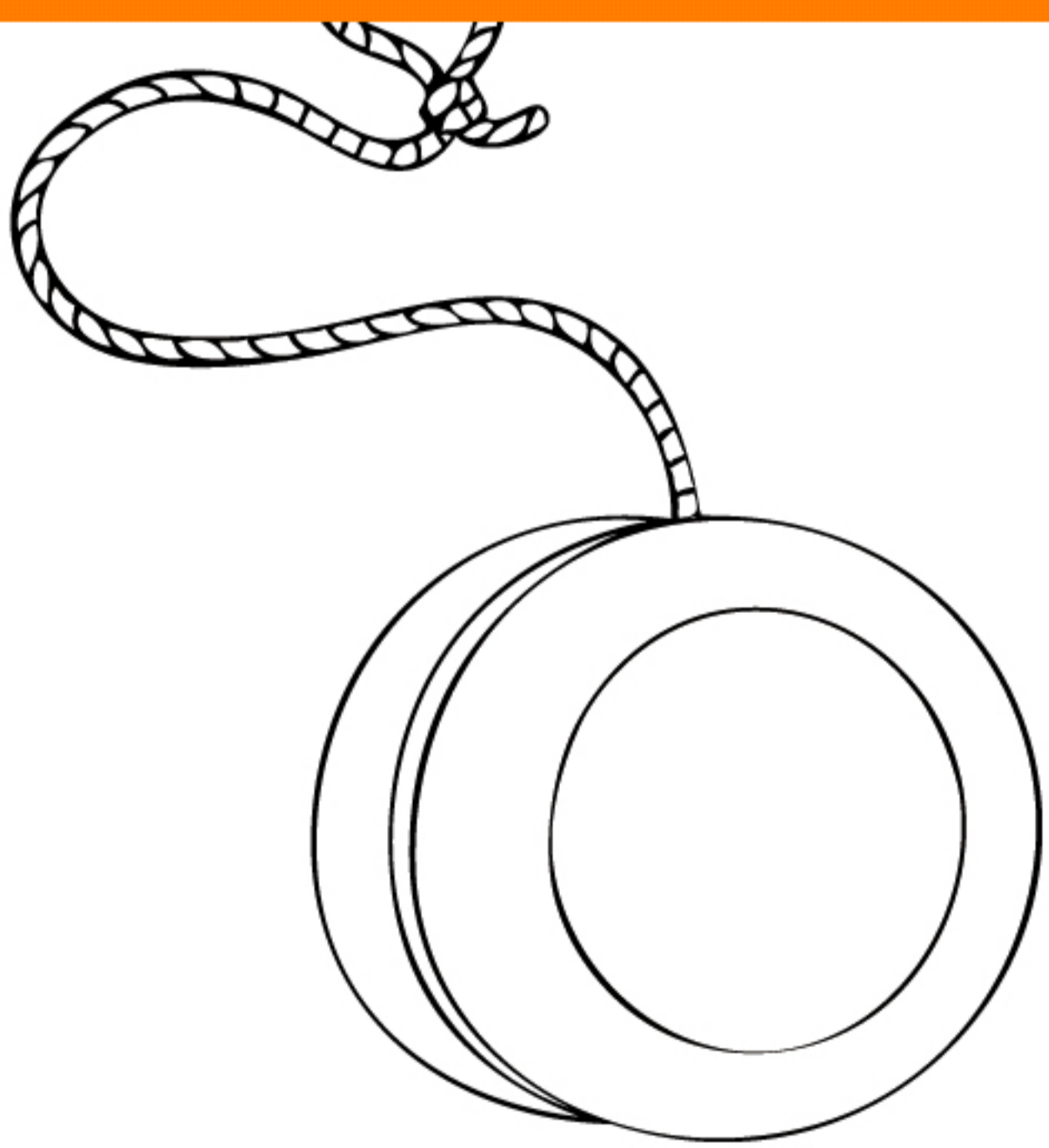

.....0-.....0



.....ol.....

Lettere straniere J K W X Y

- Completa le parole con le giuste lettere.

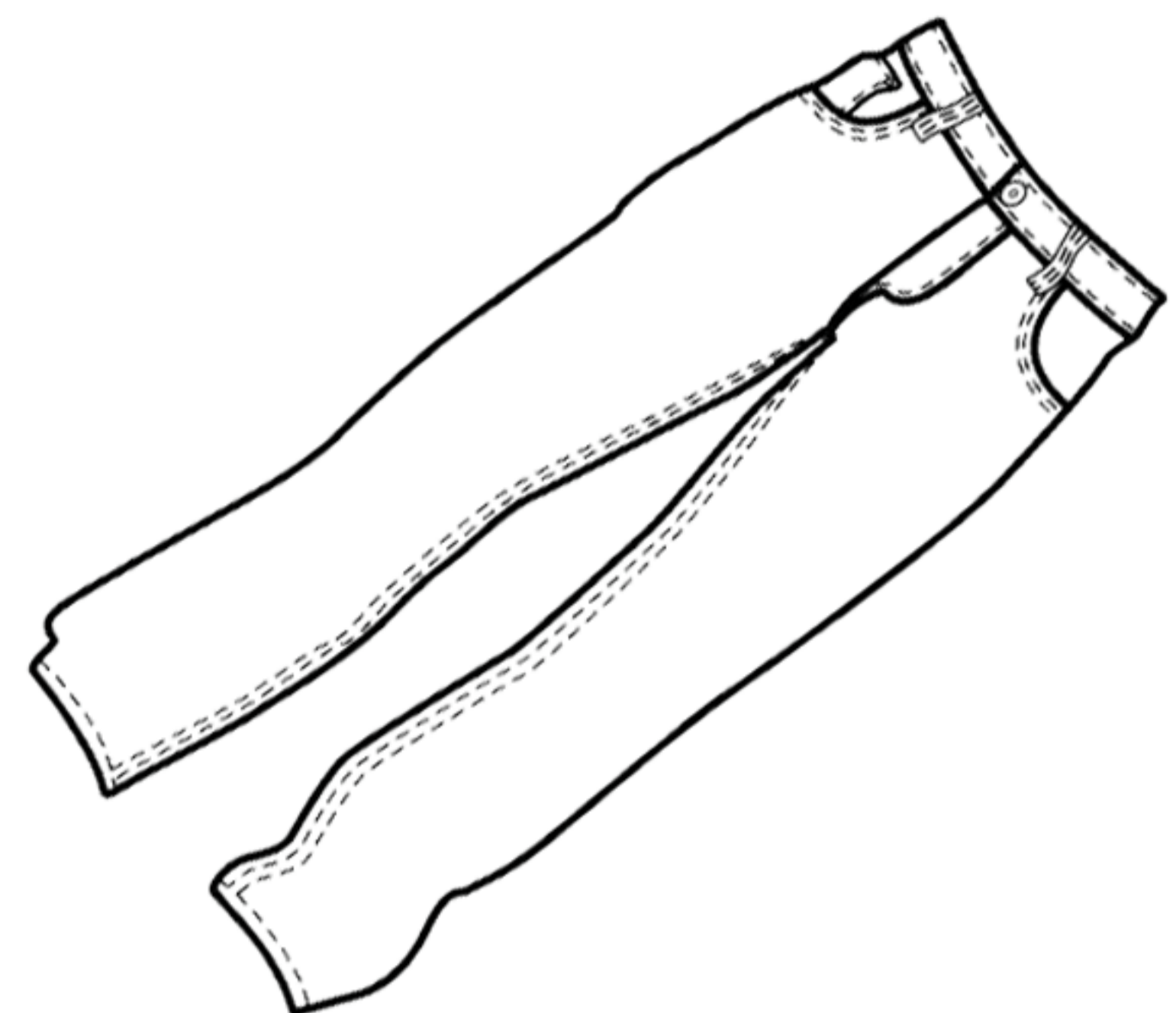

Questa è una copia
dimostrativa.

Tutti i nostri eBook possono
essere acquistati sul sito.

©Pianetabambini.it

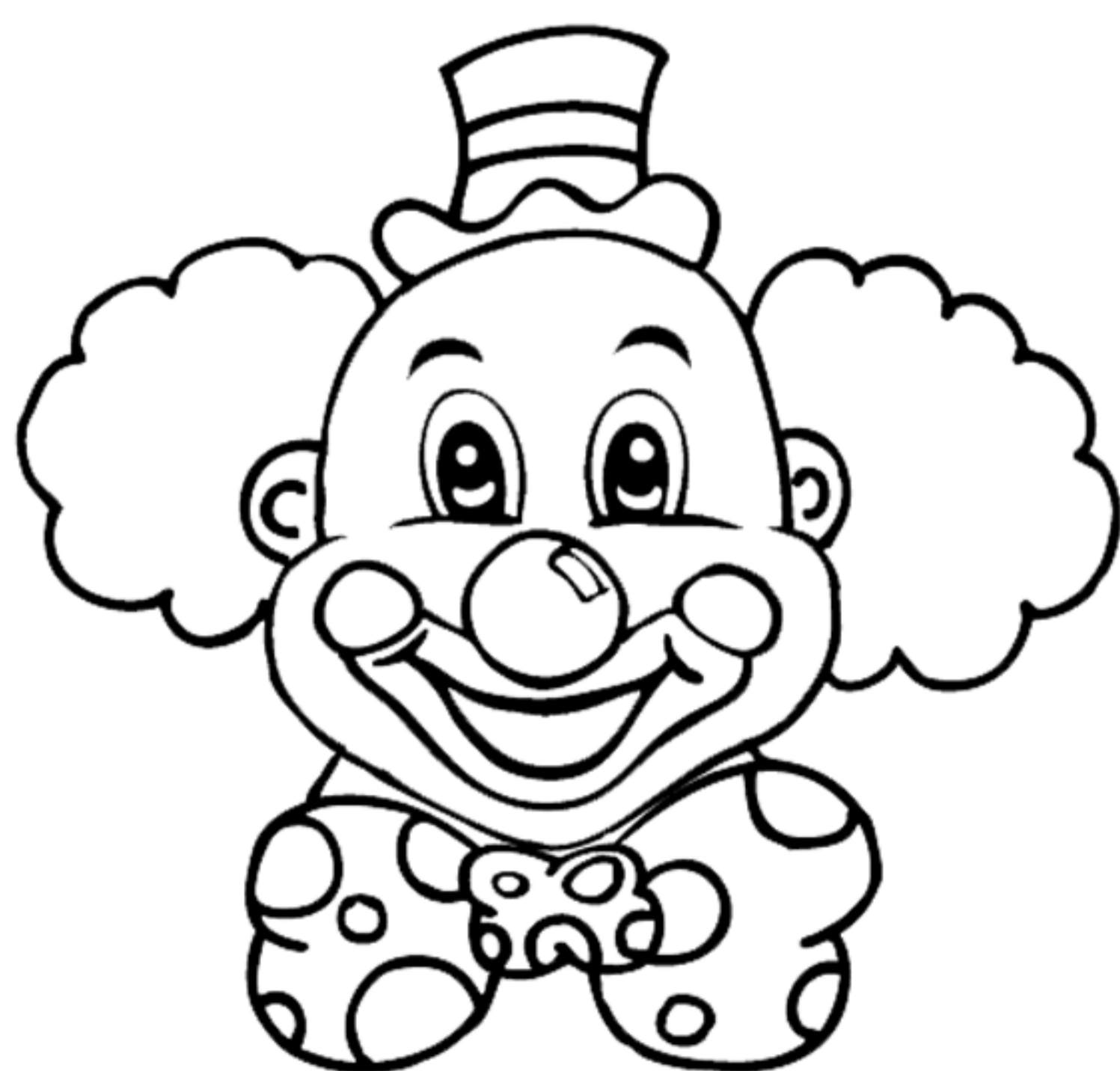

Clo.....n

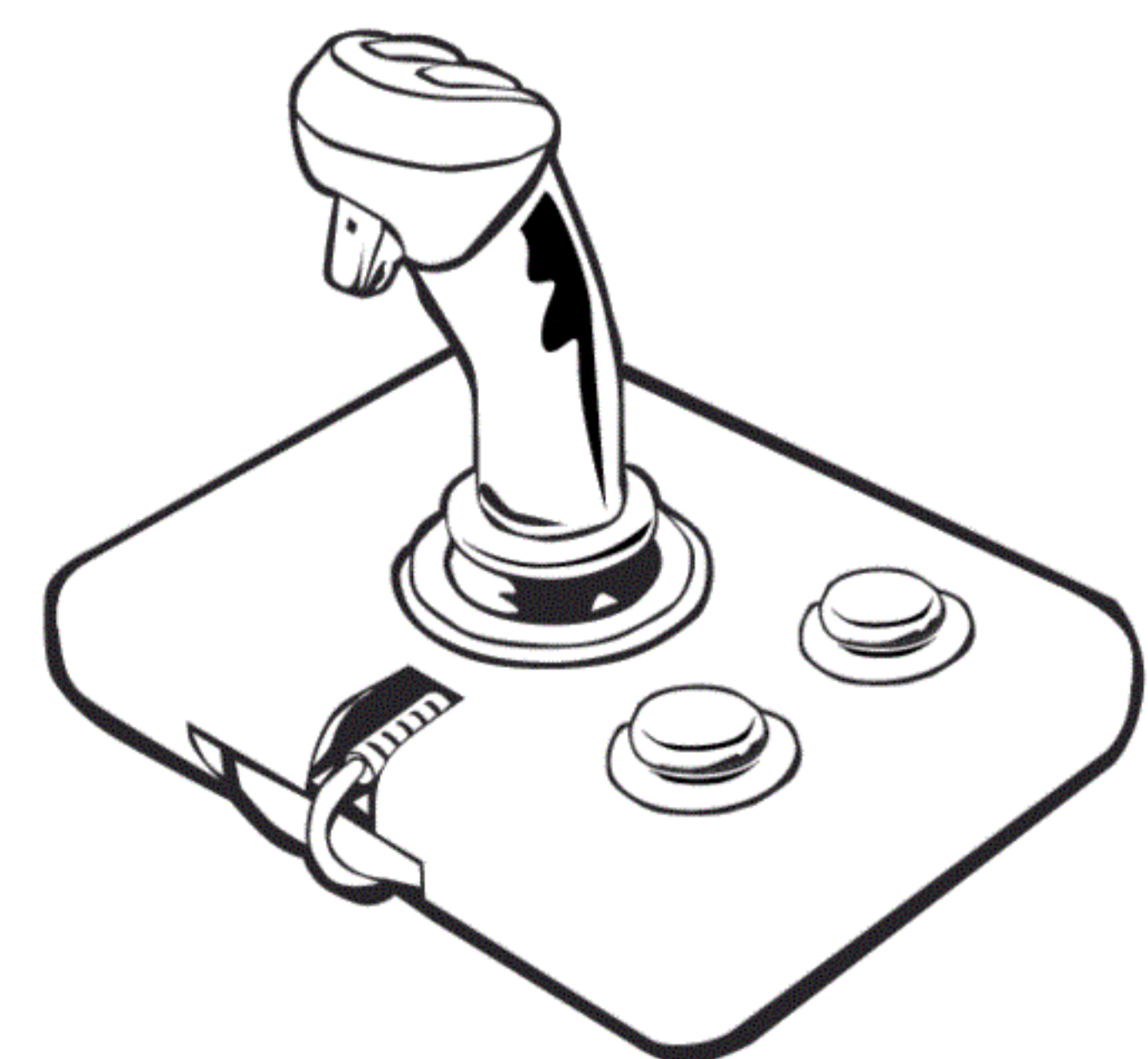

.....o.....istic.....