

Cruciverba

Abbigliamento

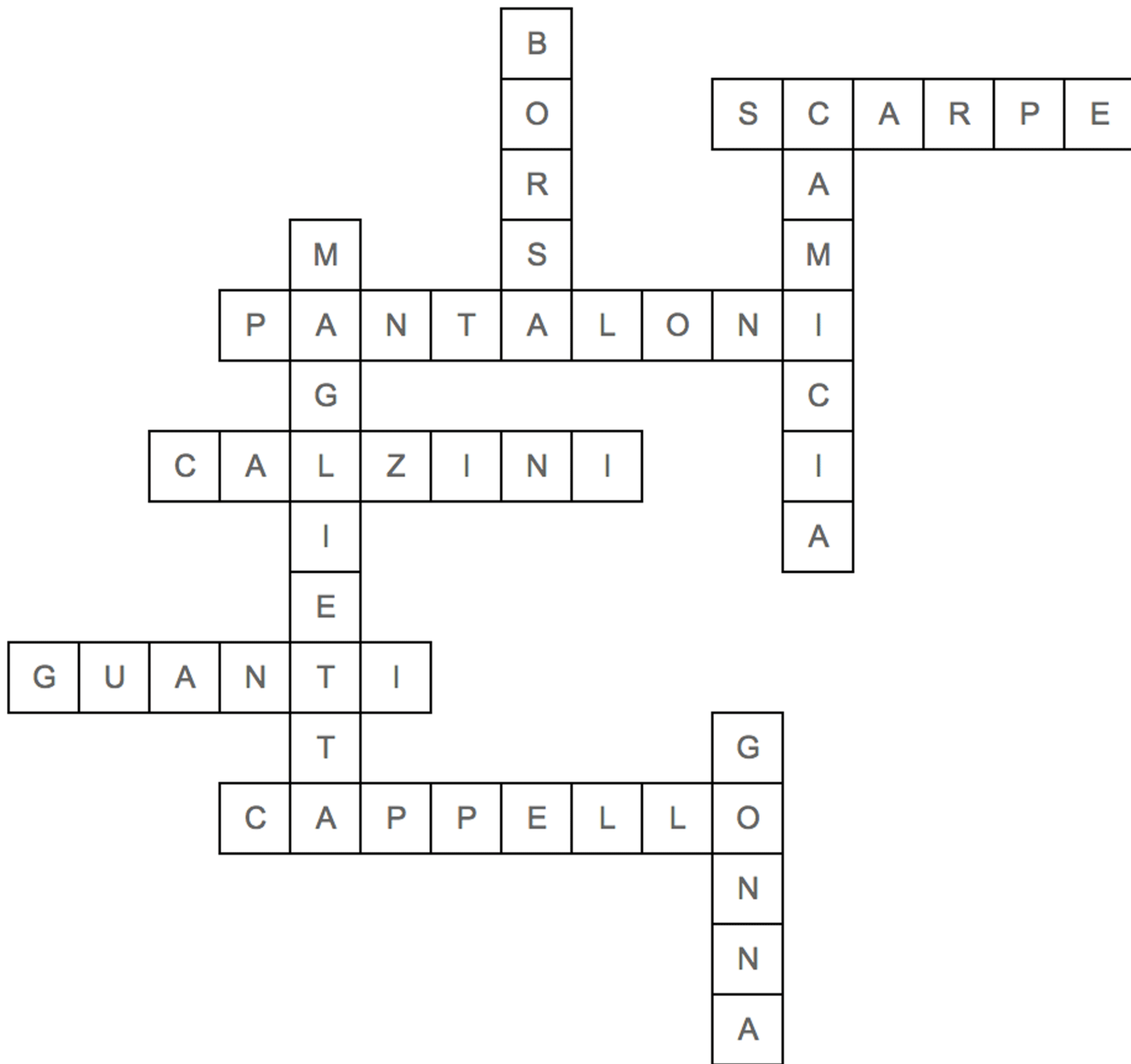

Orizzontali →

Verticali ↓

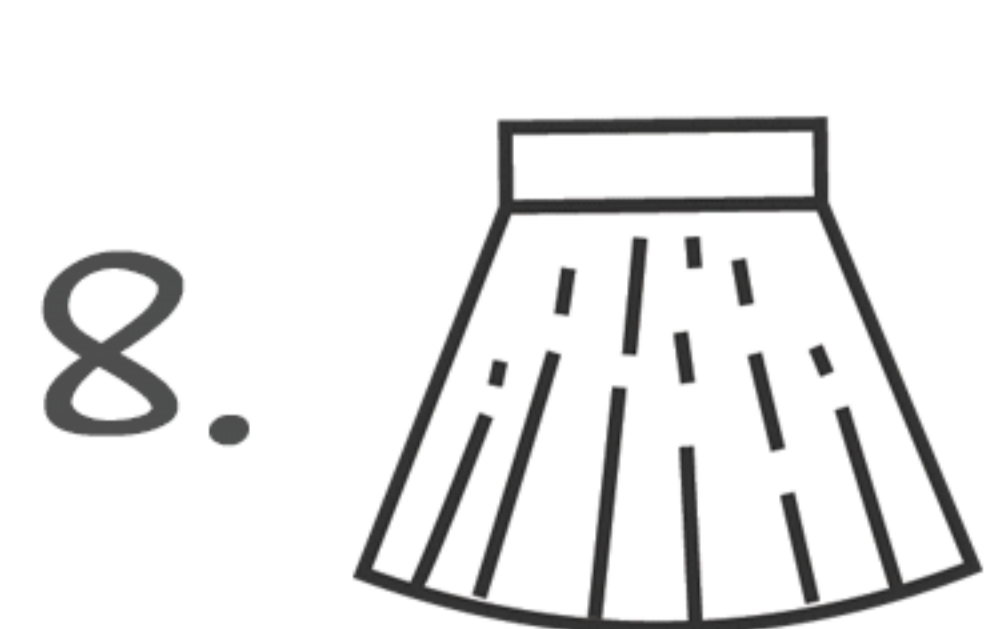
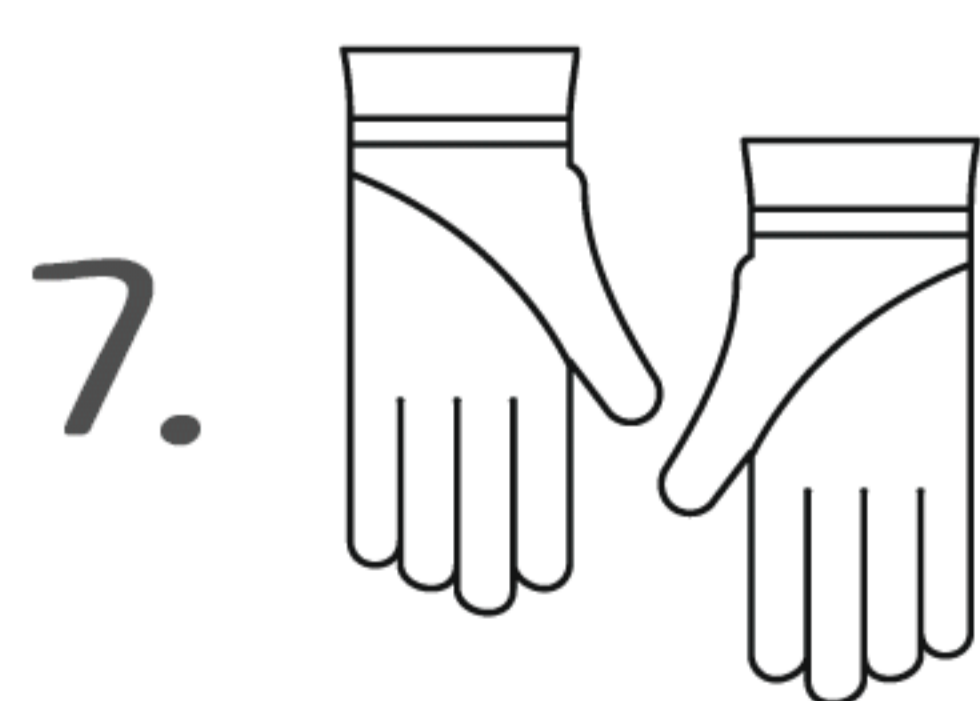
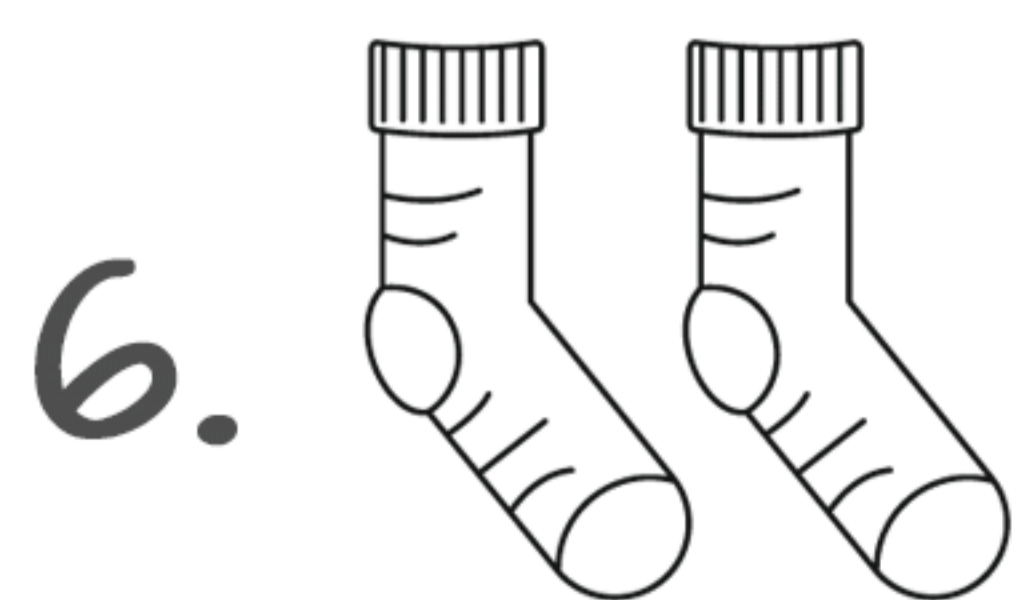
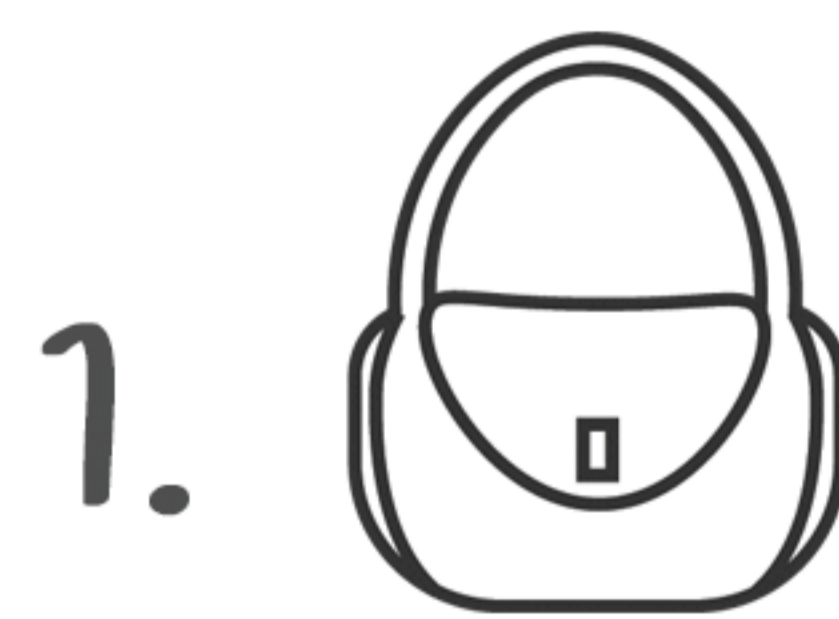
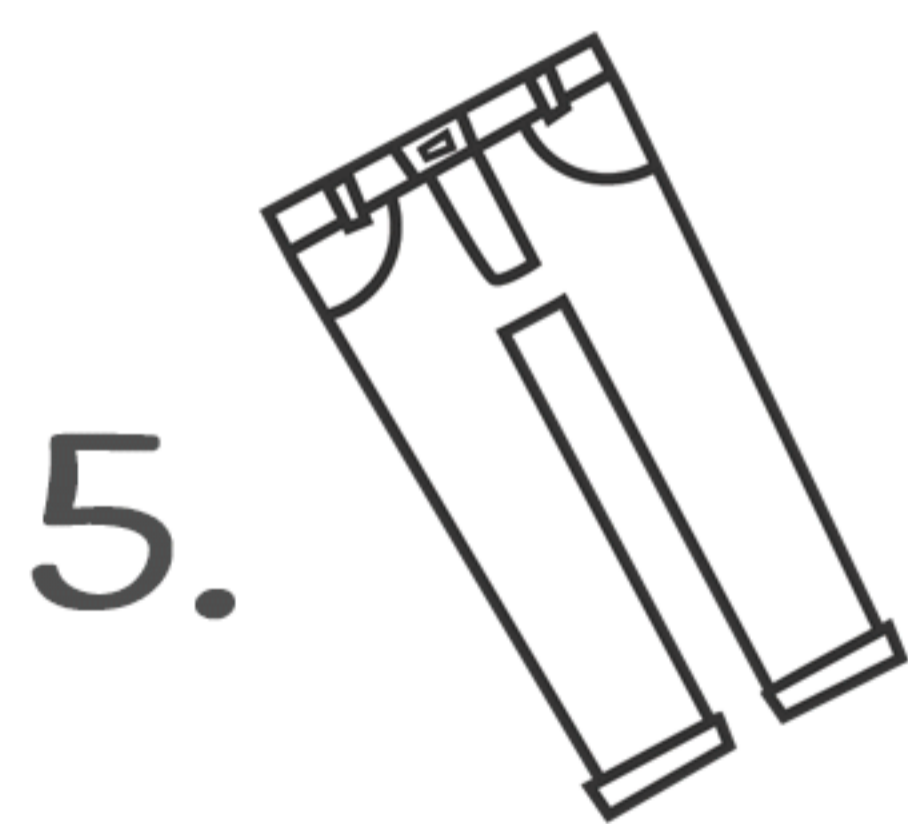
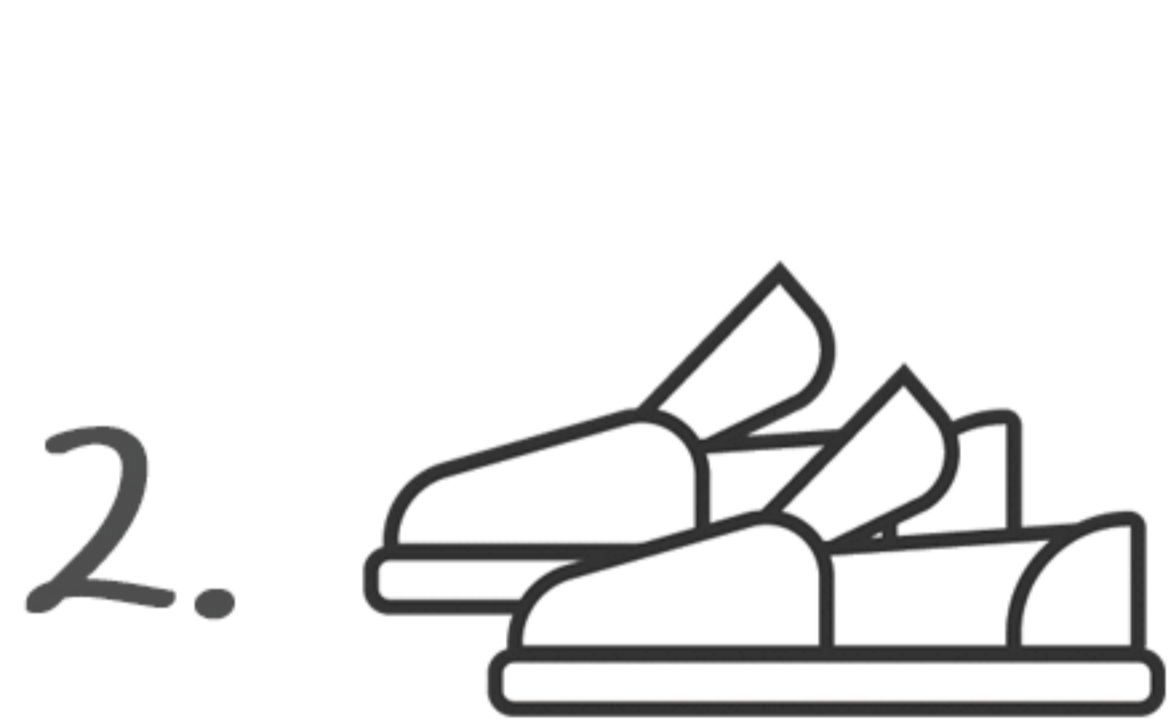

Cruciverba

Animali del bosco

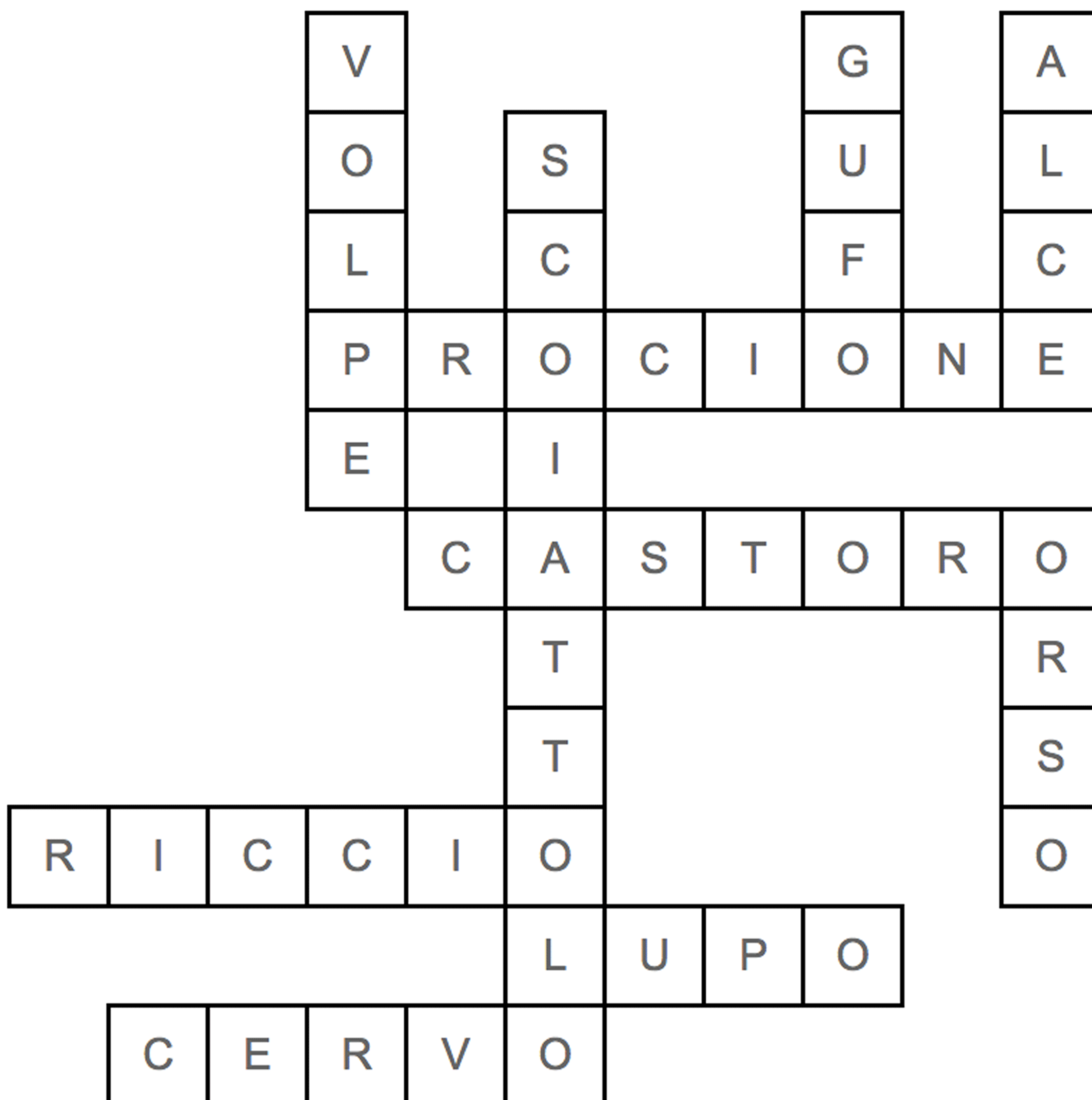

Orizzontali →

Verticali ↓

5.

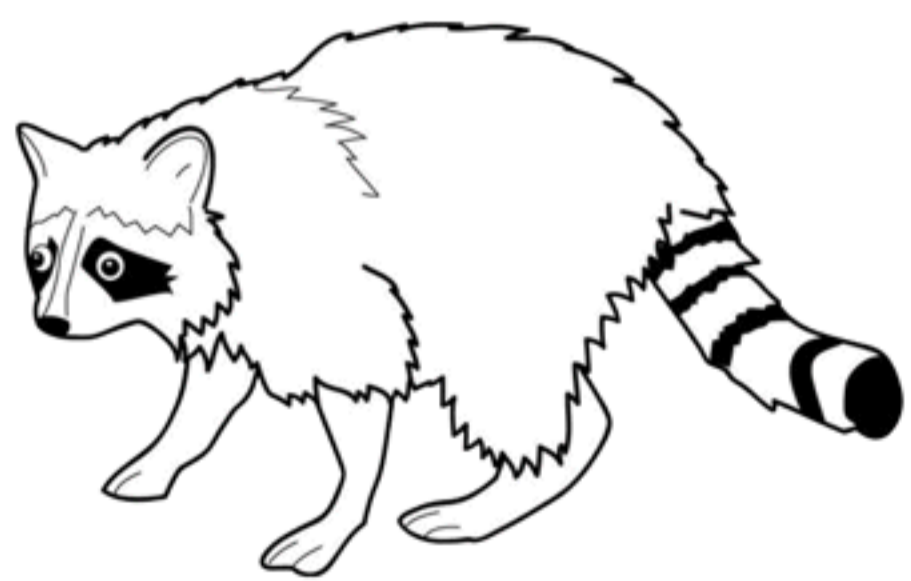

6.



1.

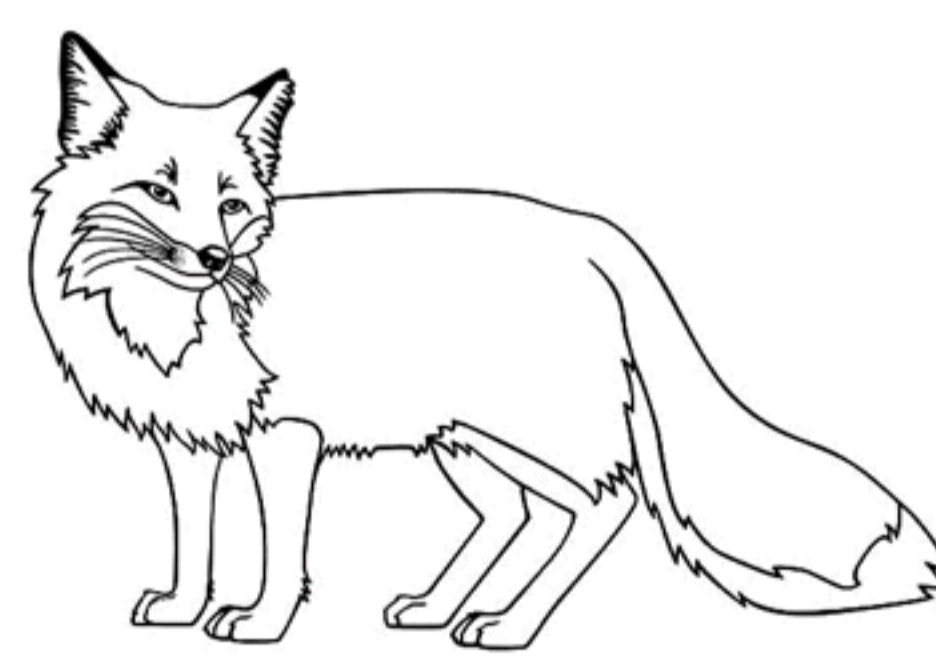

2.



8.



9.



3.



4.



10.

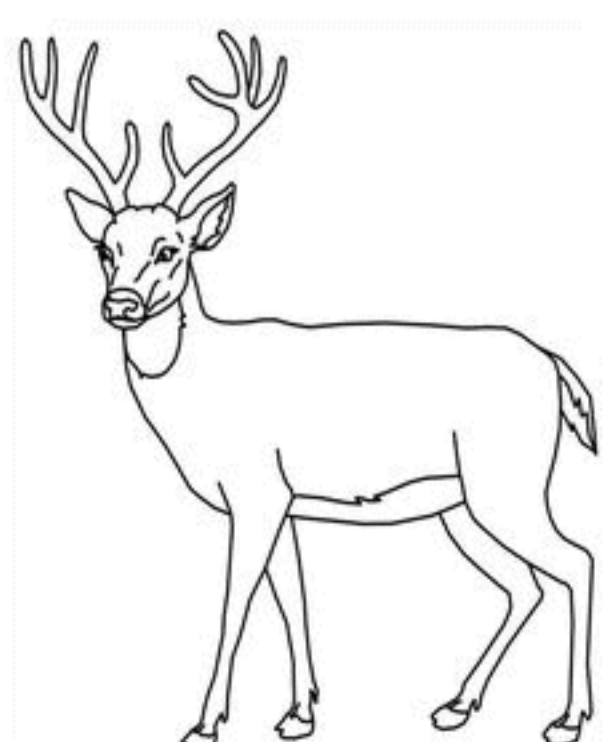

7.



Cruciverba

Animali domestici

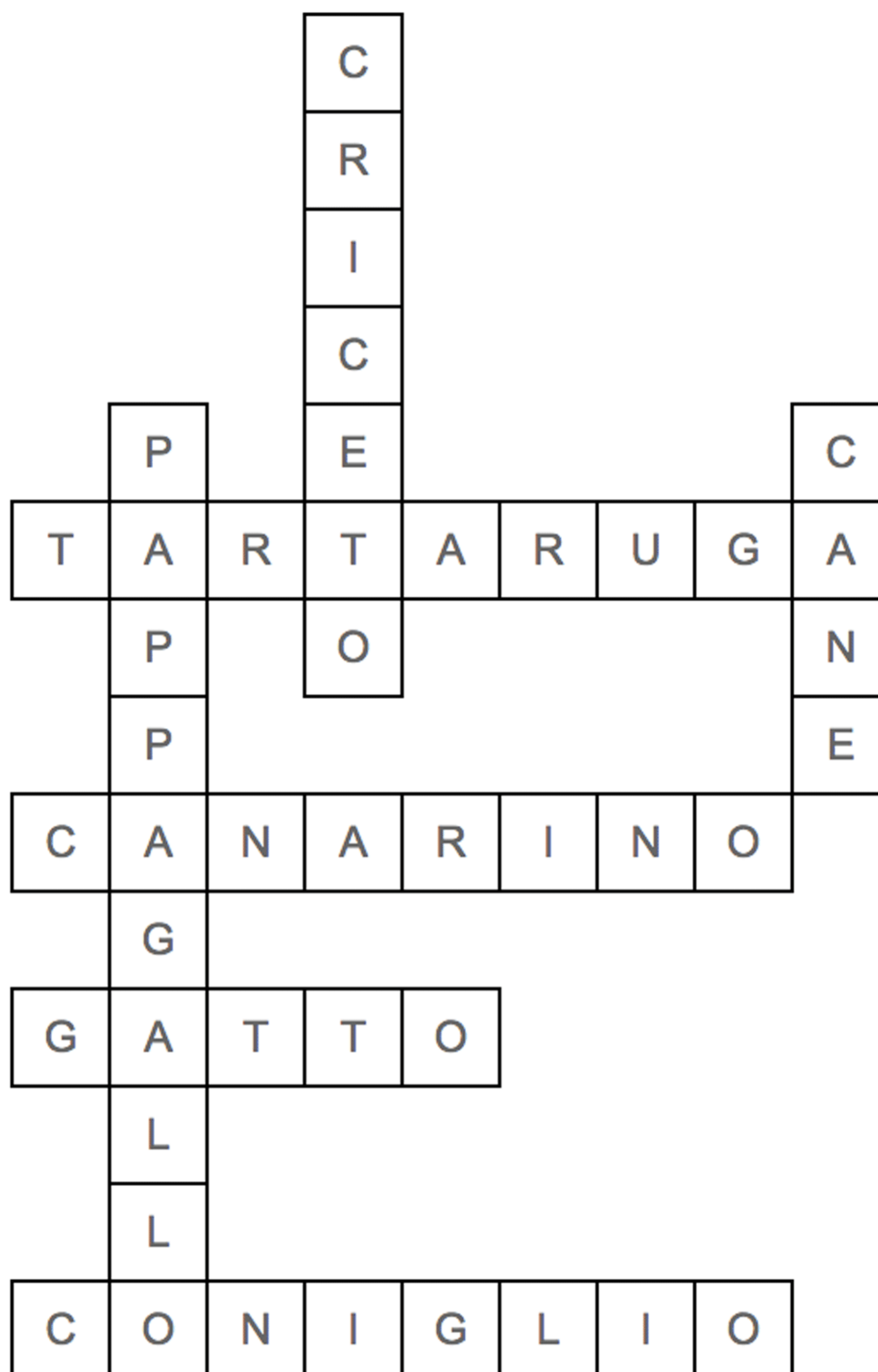

Orizzontali →

Verticali ↓

4.

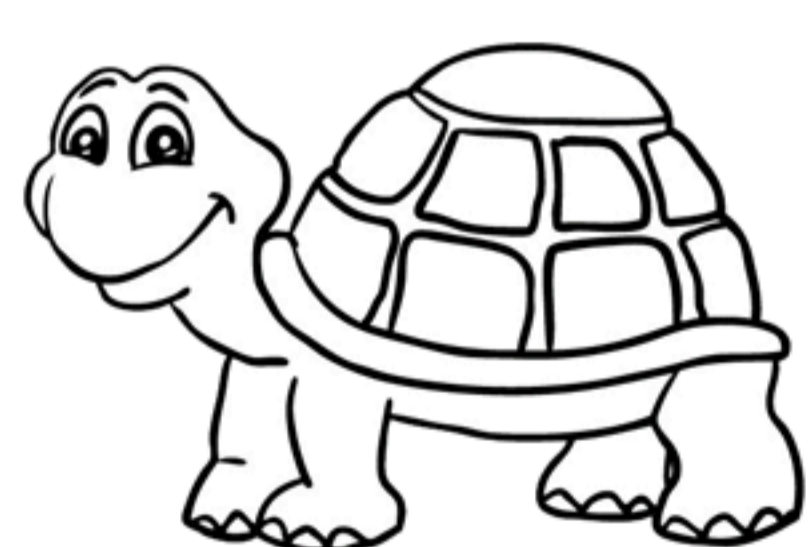

5.

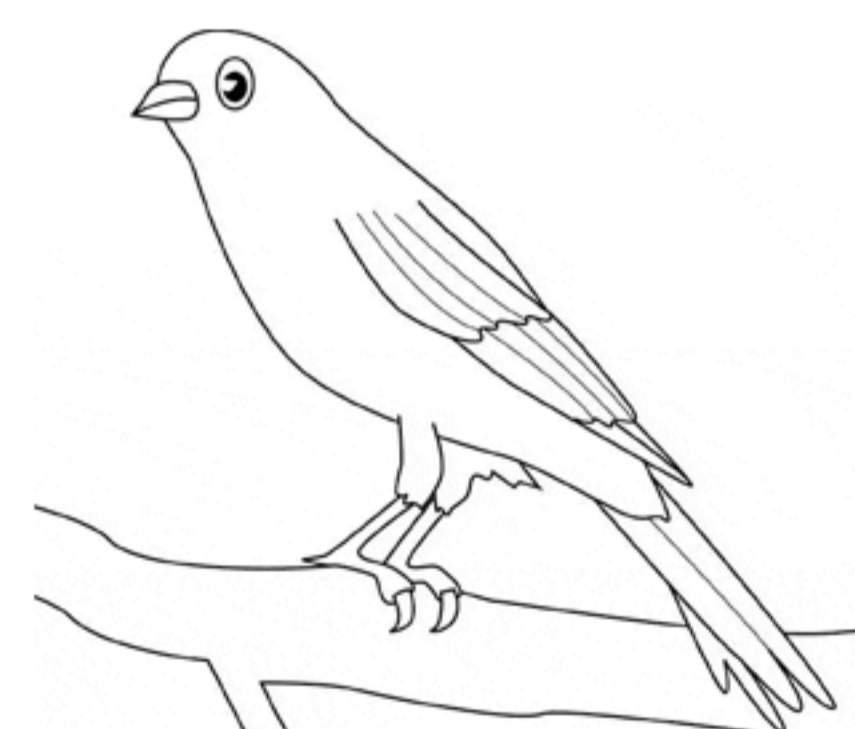

6.



7.

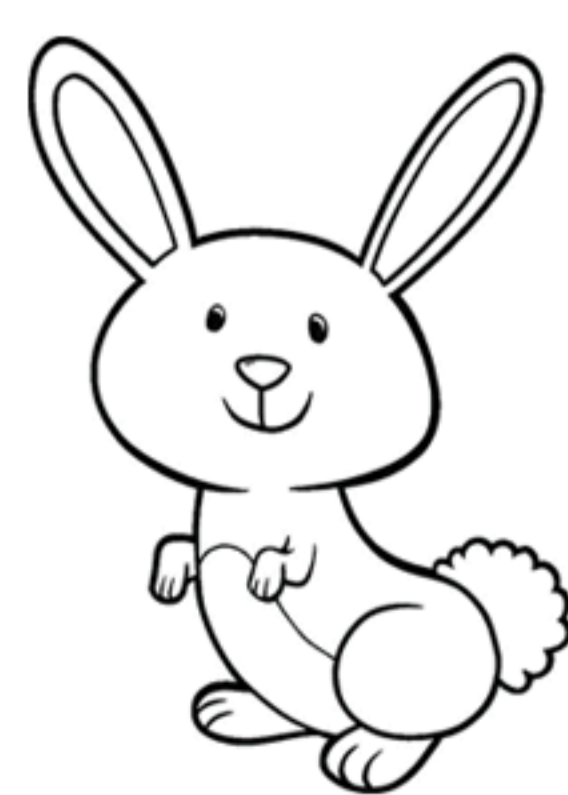

1.



2.



3.



Cruciverba

Animali della fattoria

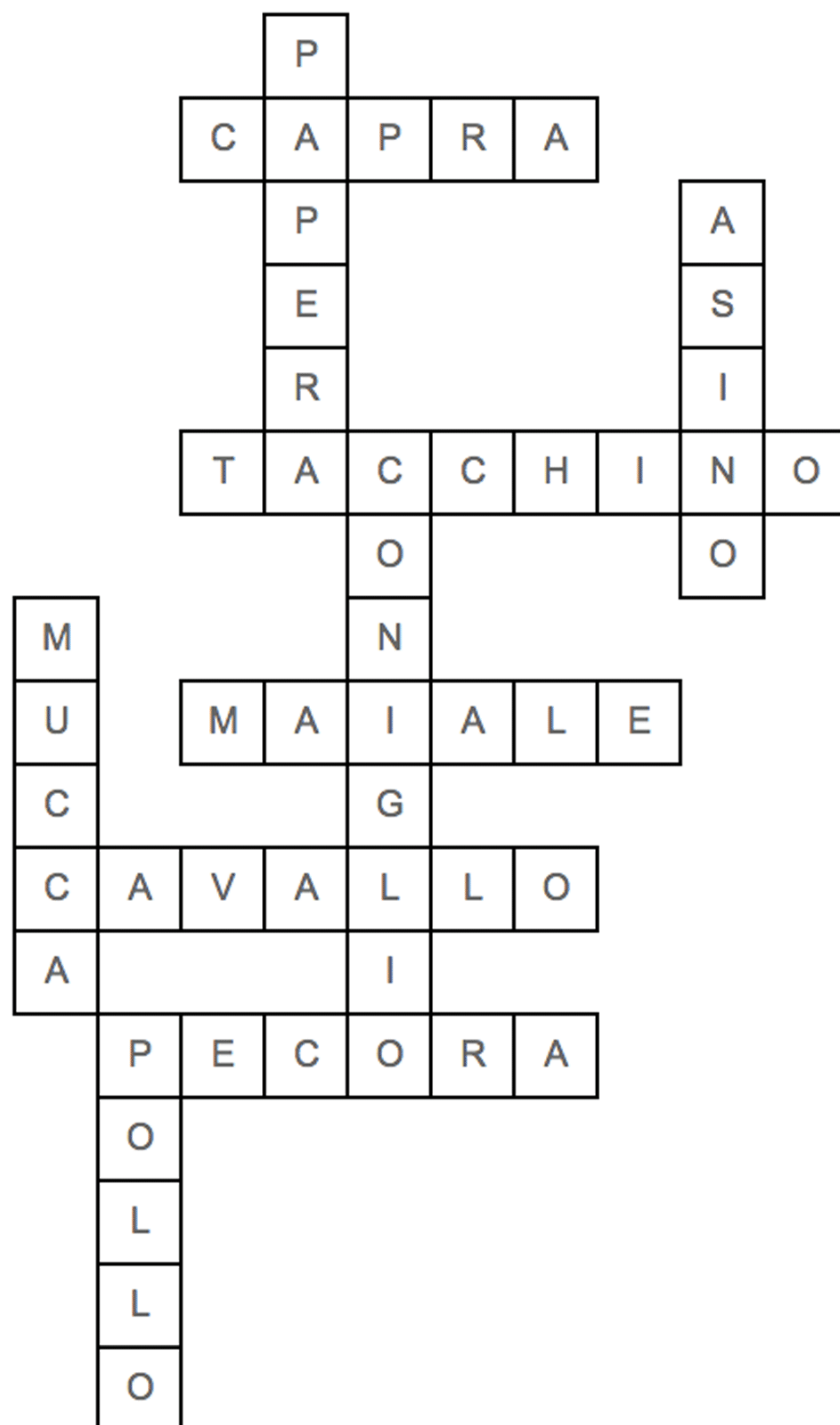

Orizzontali →

Verticali ↓

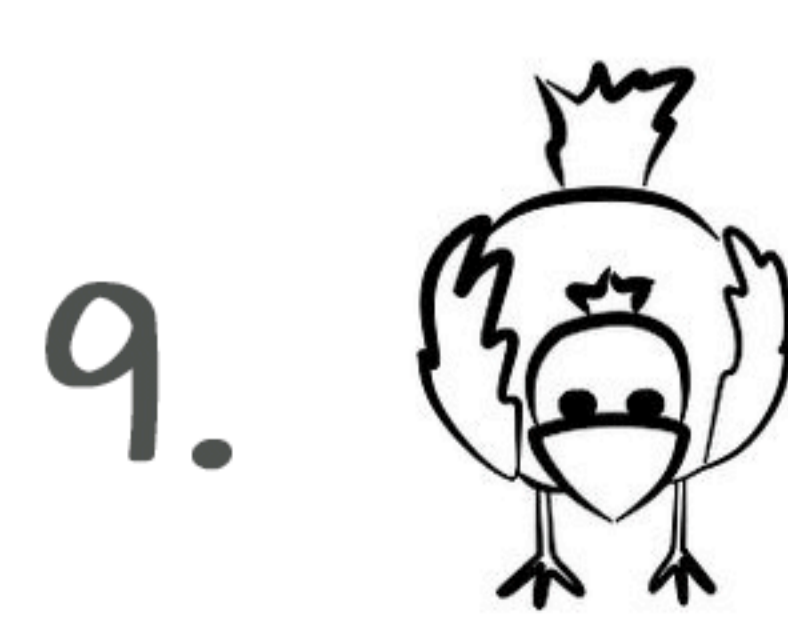
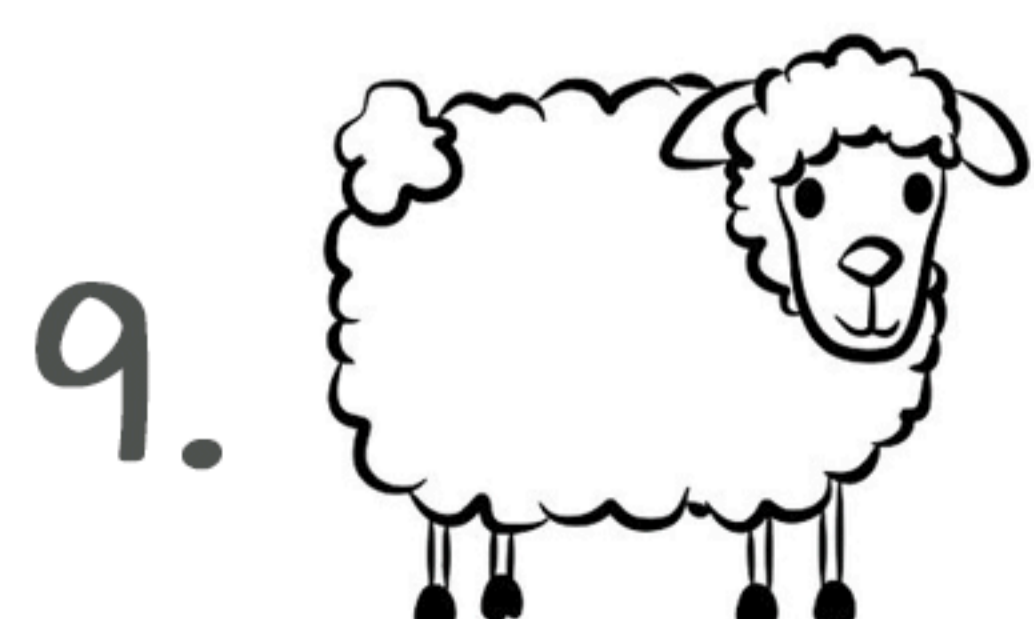
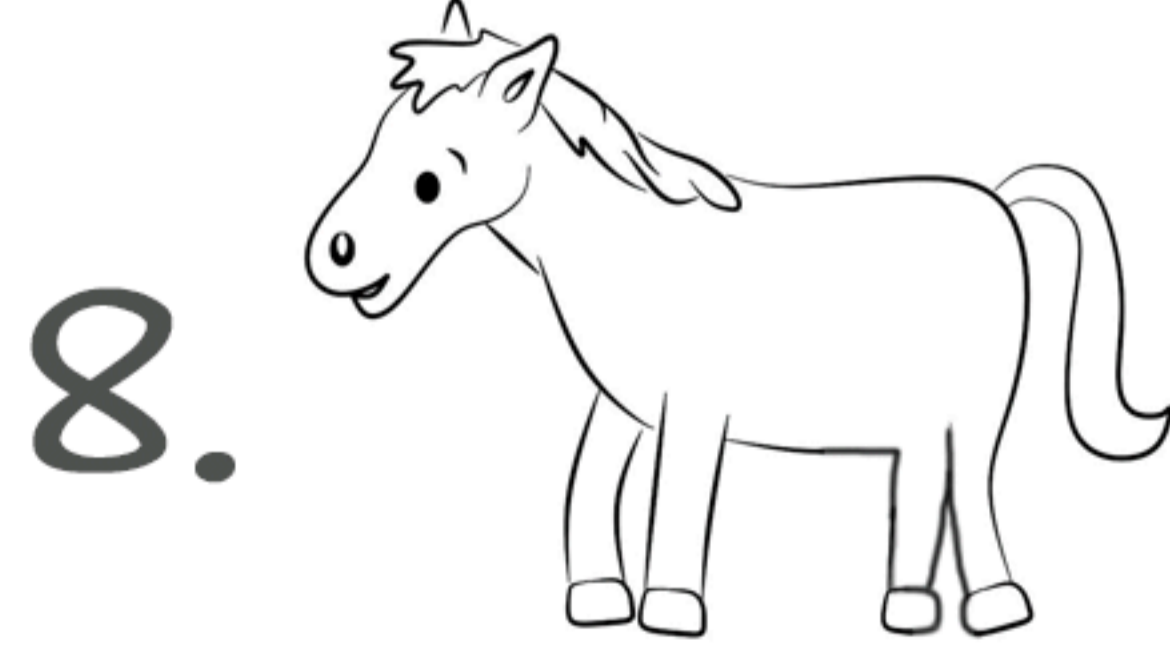
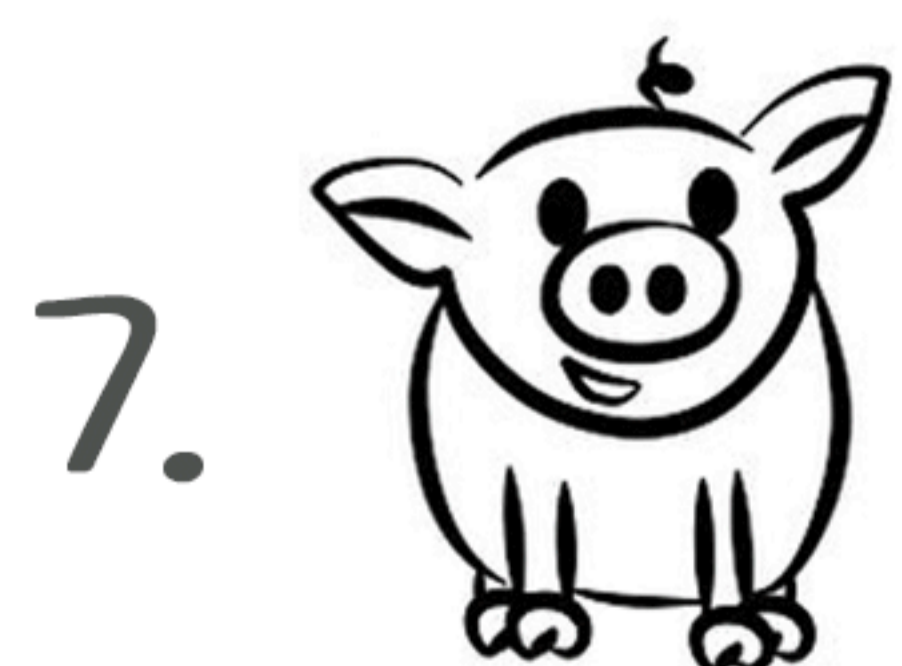
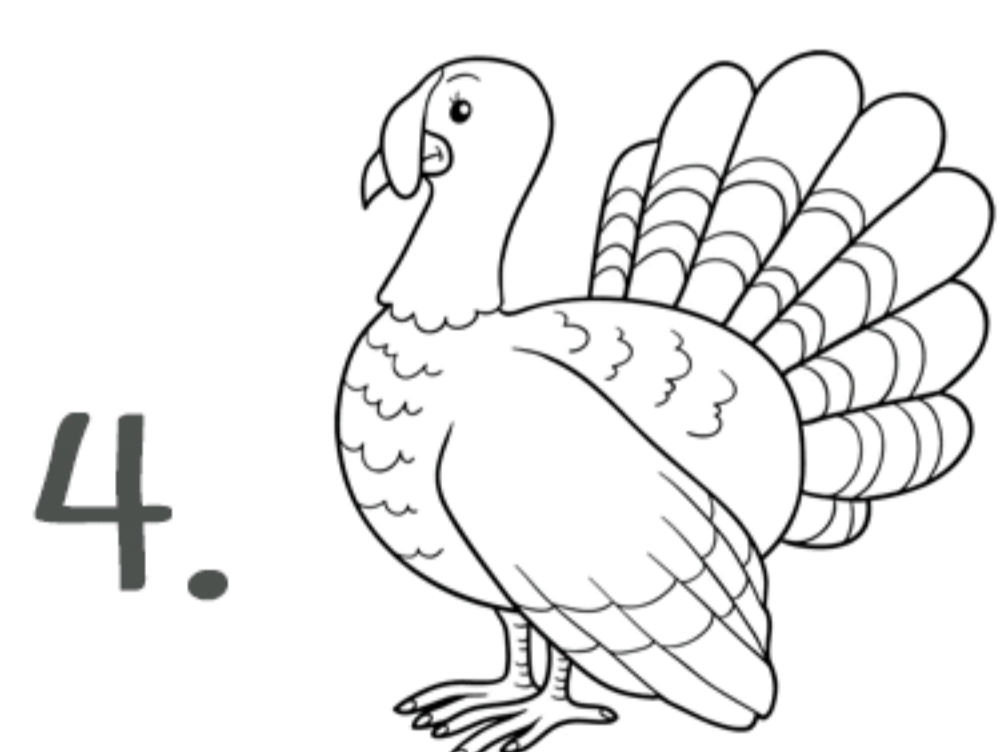
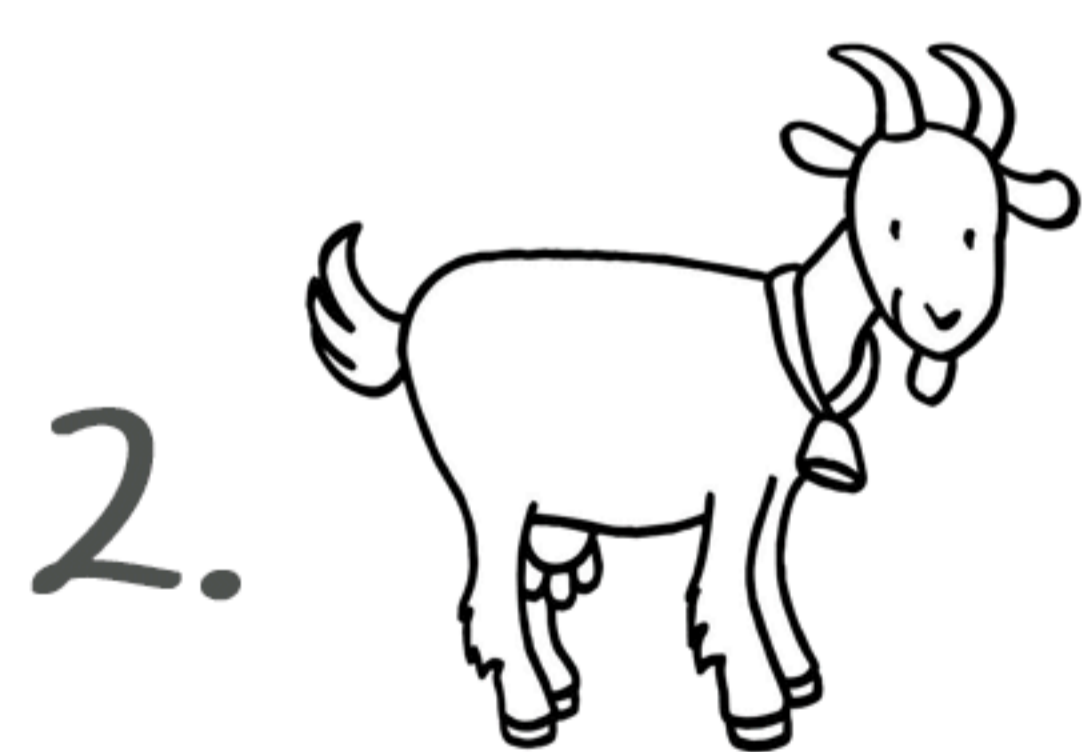

Cruciverba

Animali selvatici

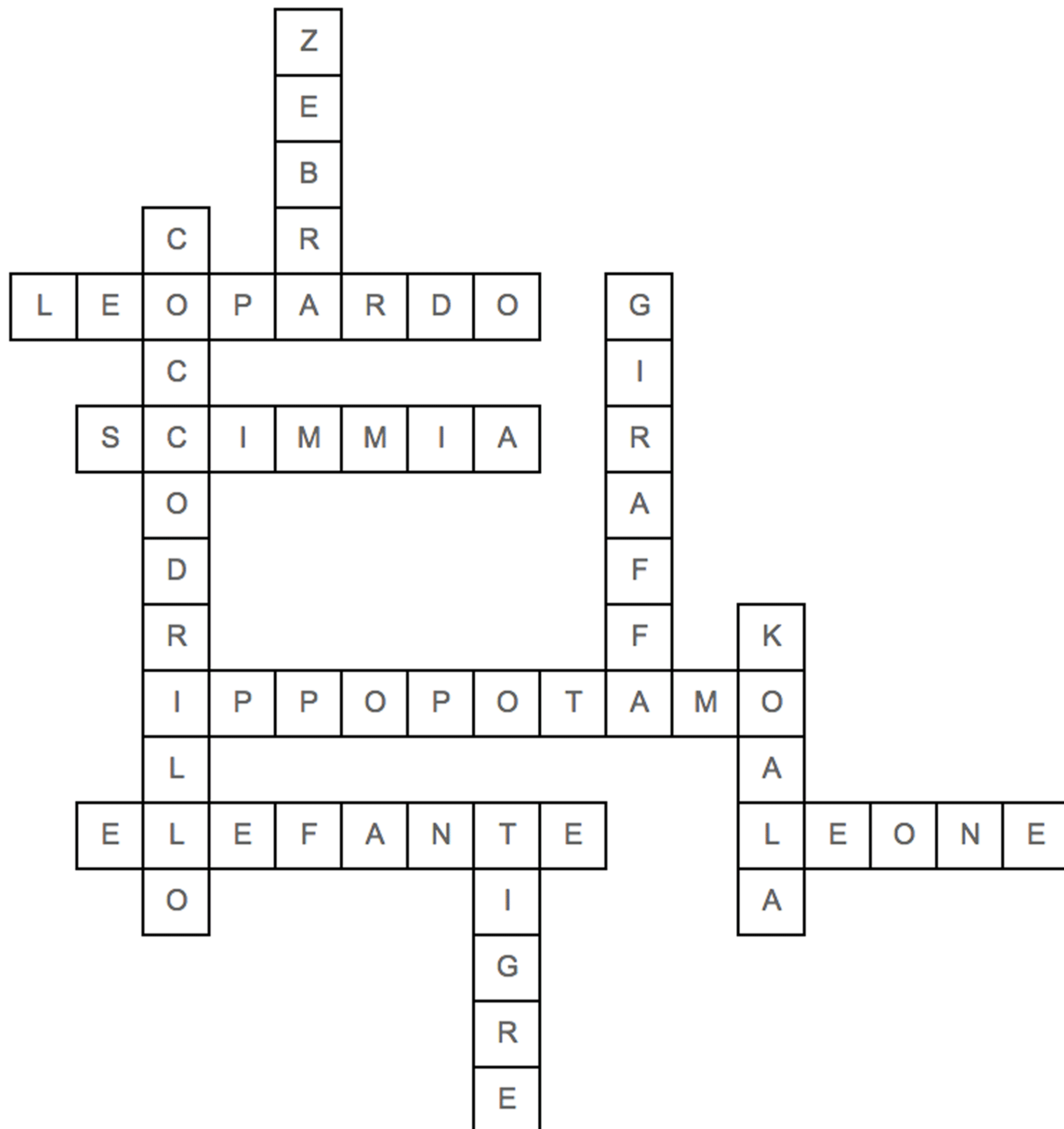

Orizzontali →

Verticali ↓

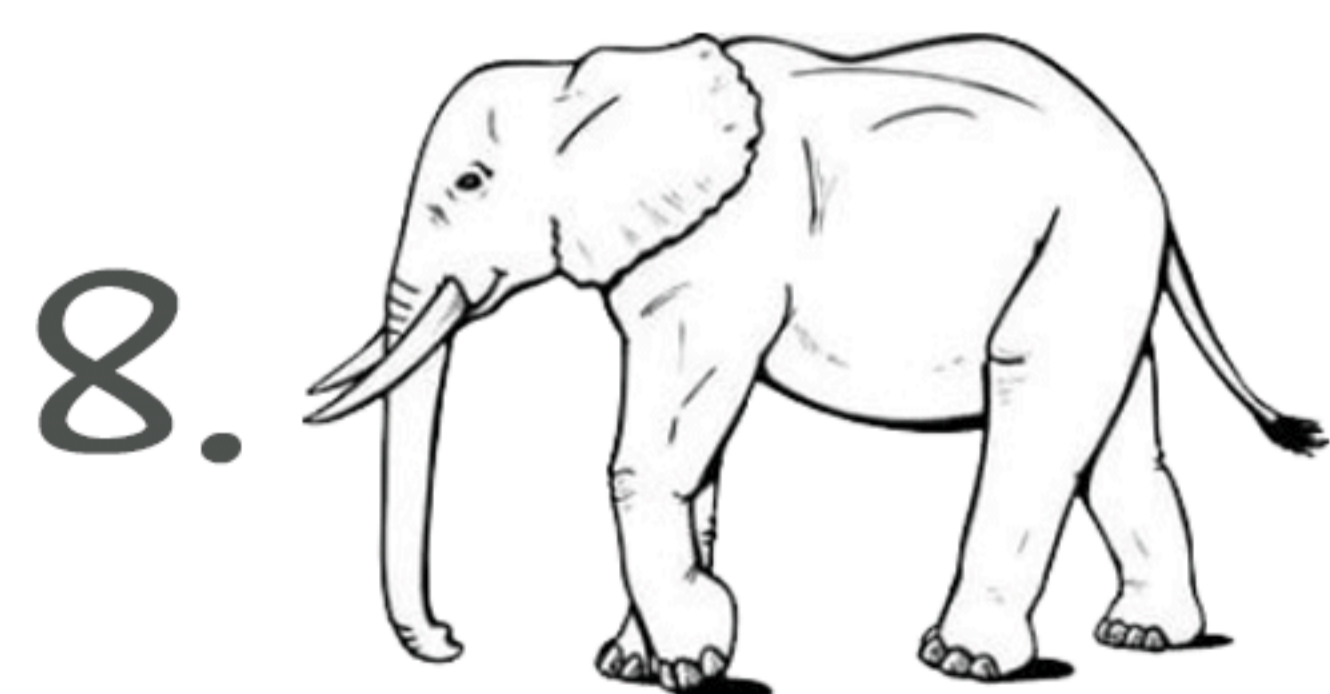
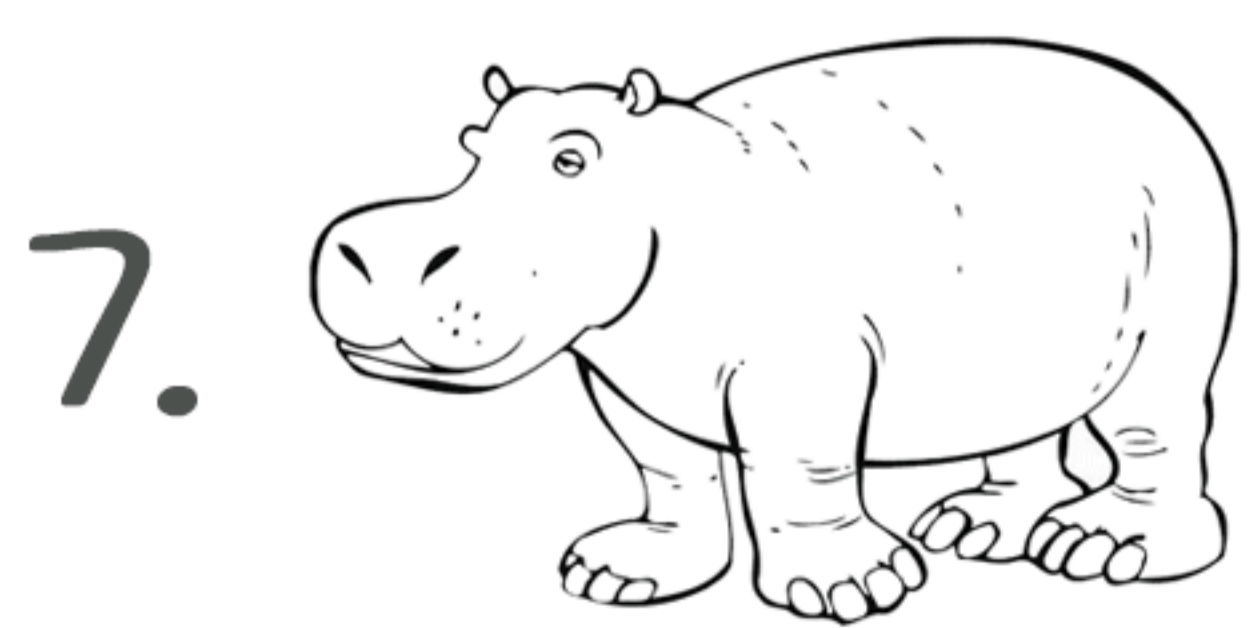
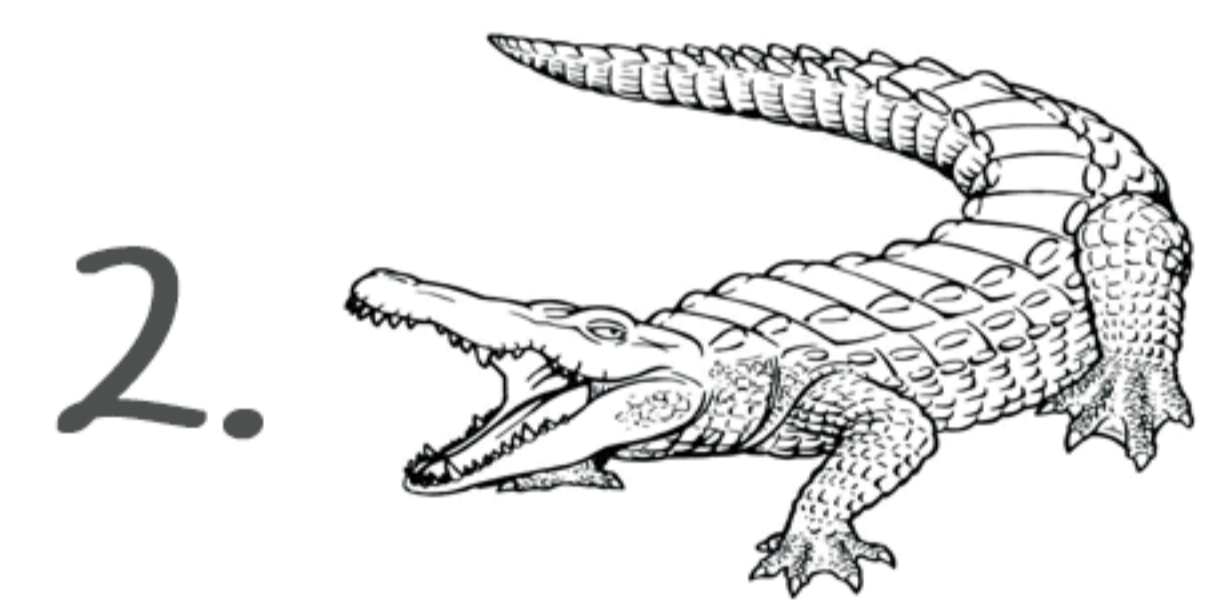
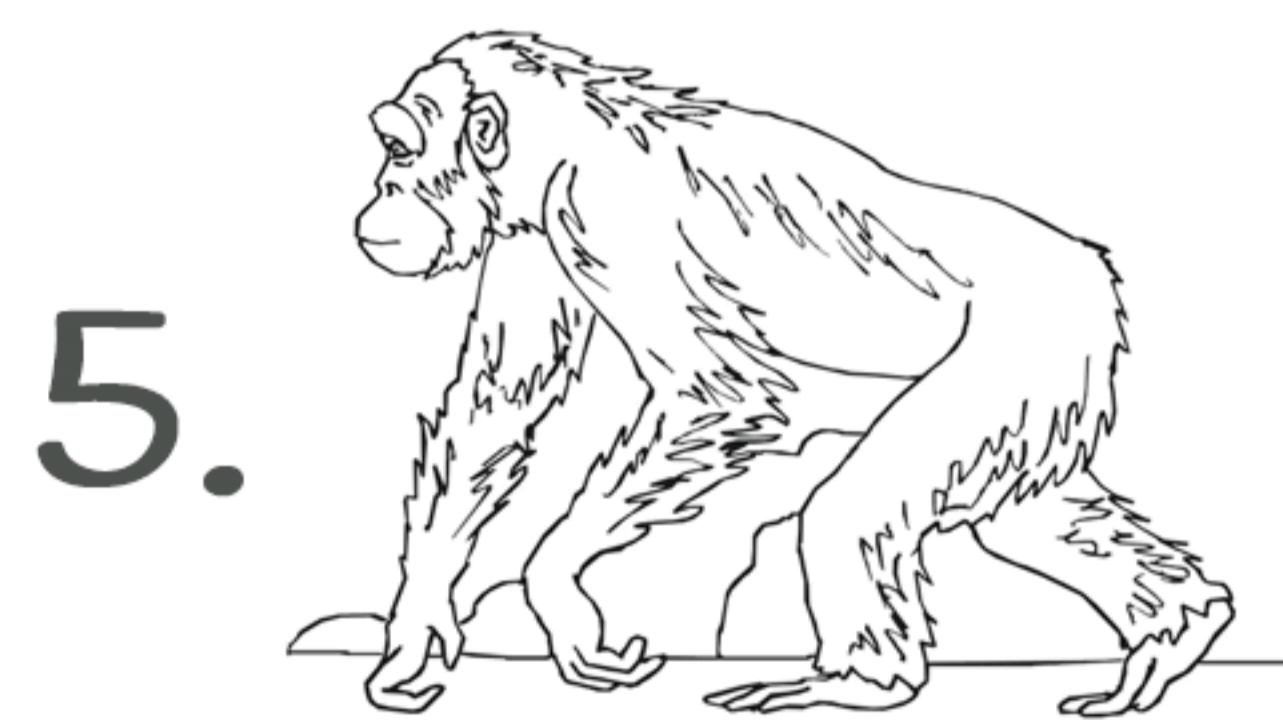

Cruciverba

Arredamento

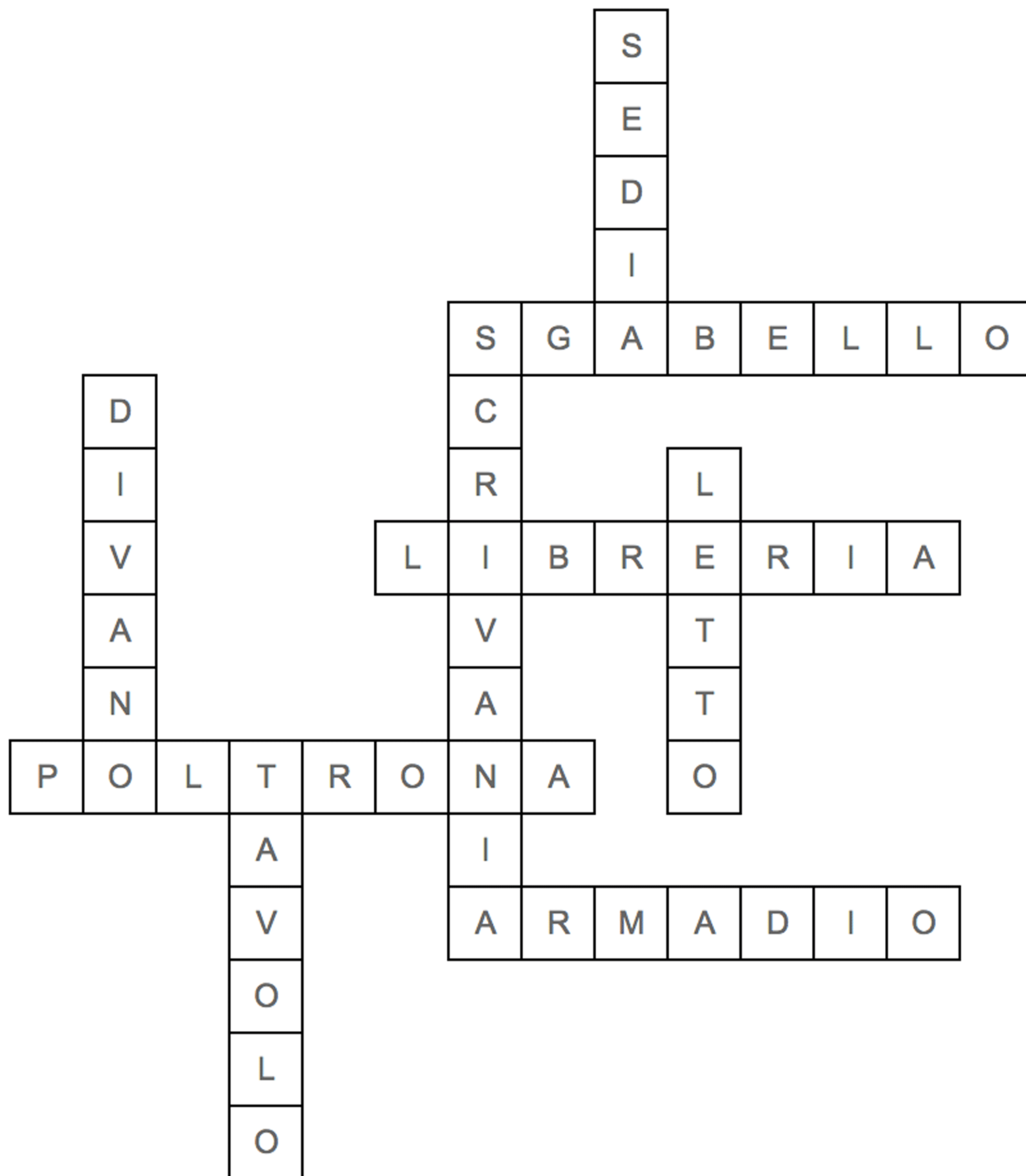

Orizzontali →

Verticali ↓

2.

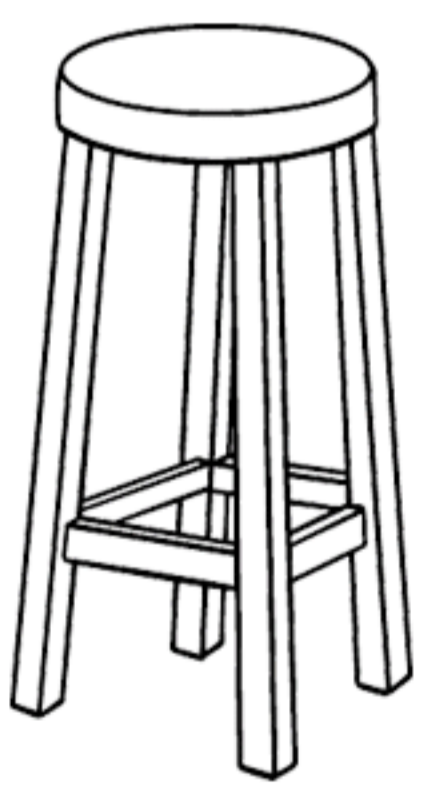

5.

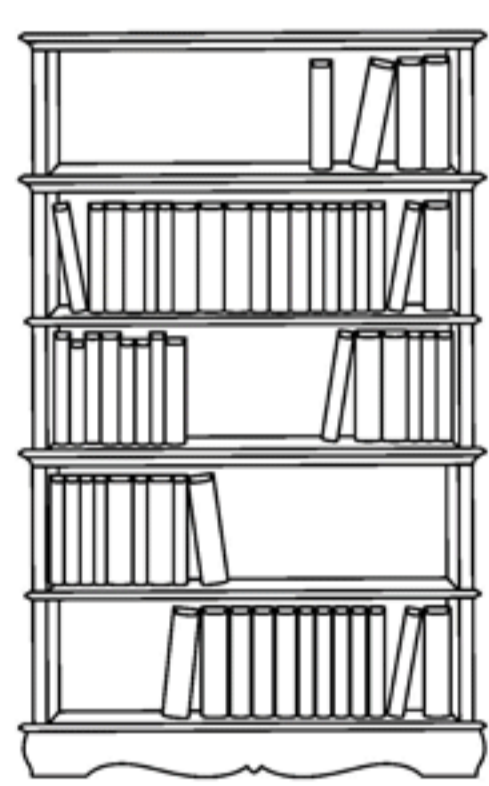

1.



2.

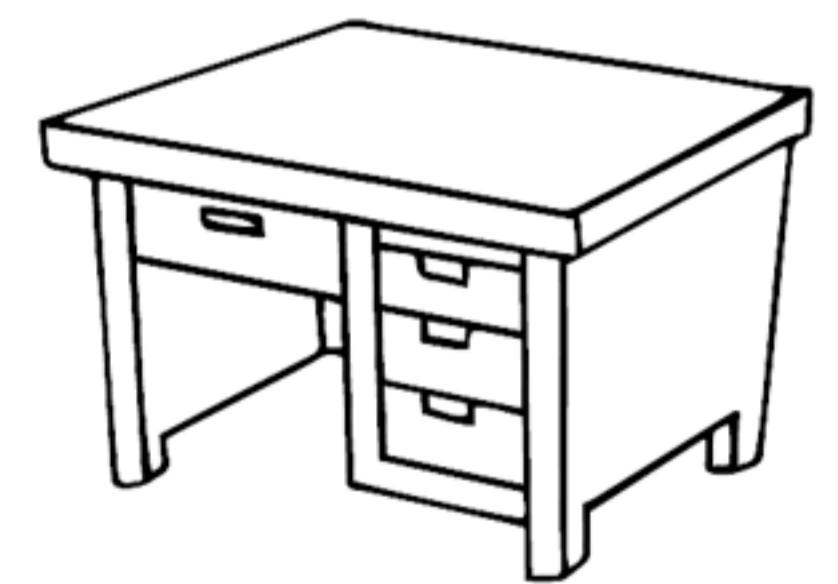

6.

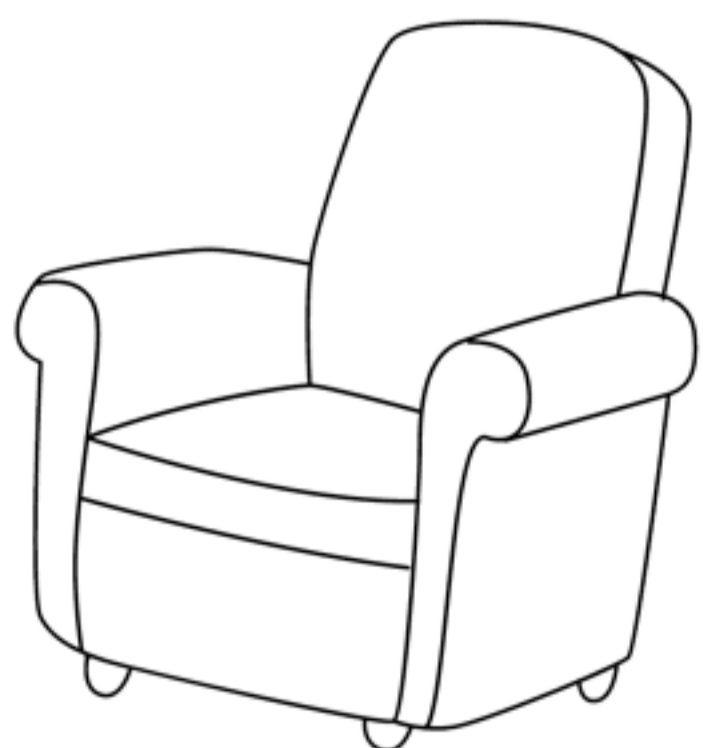

8.

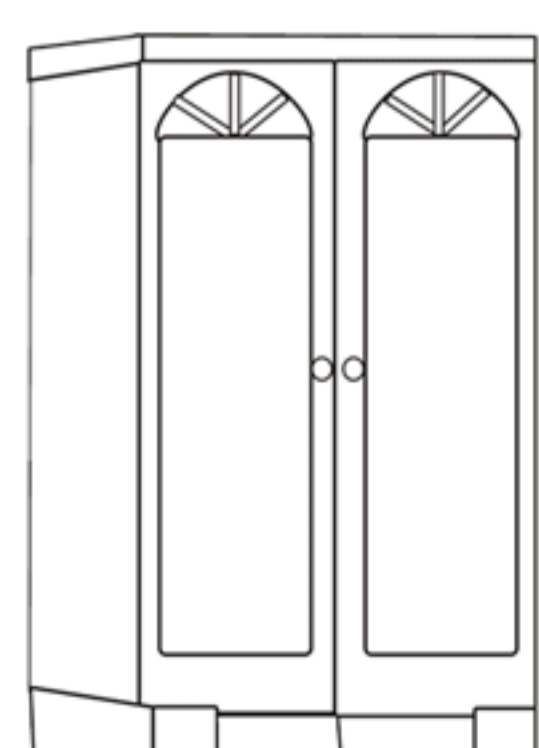

3.

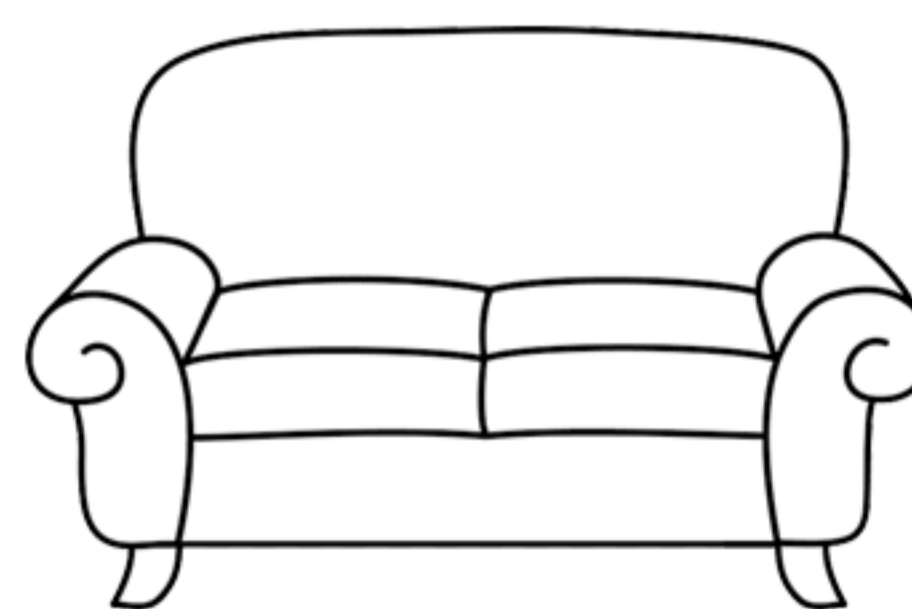

4.

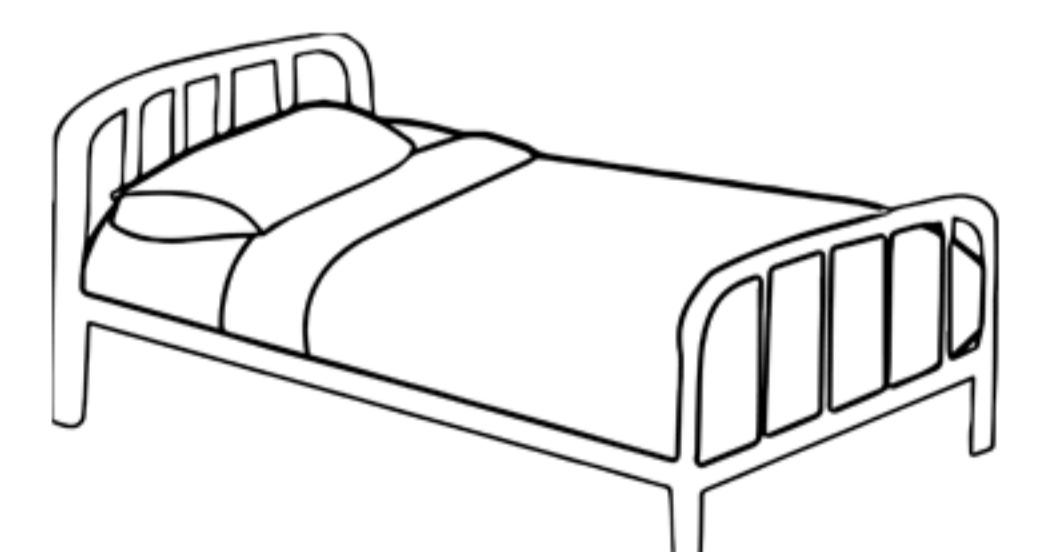

7.



Cruciverba

Cibo

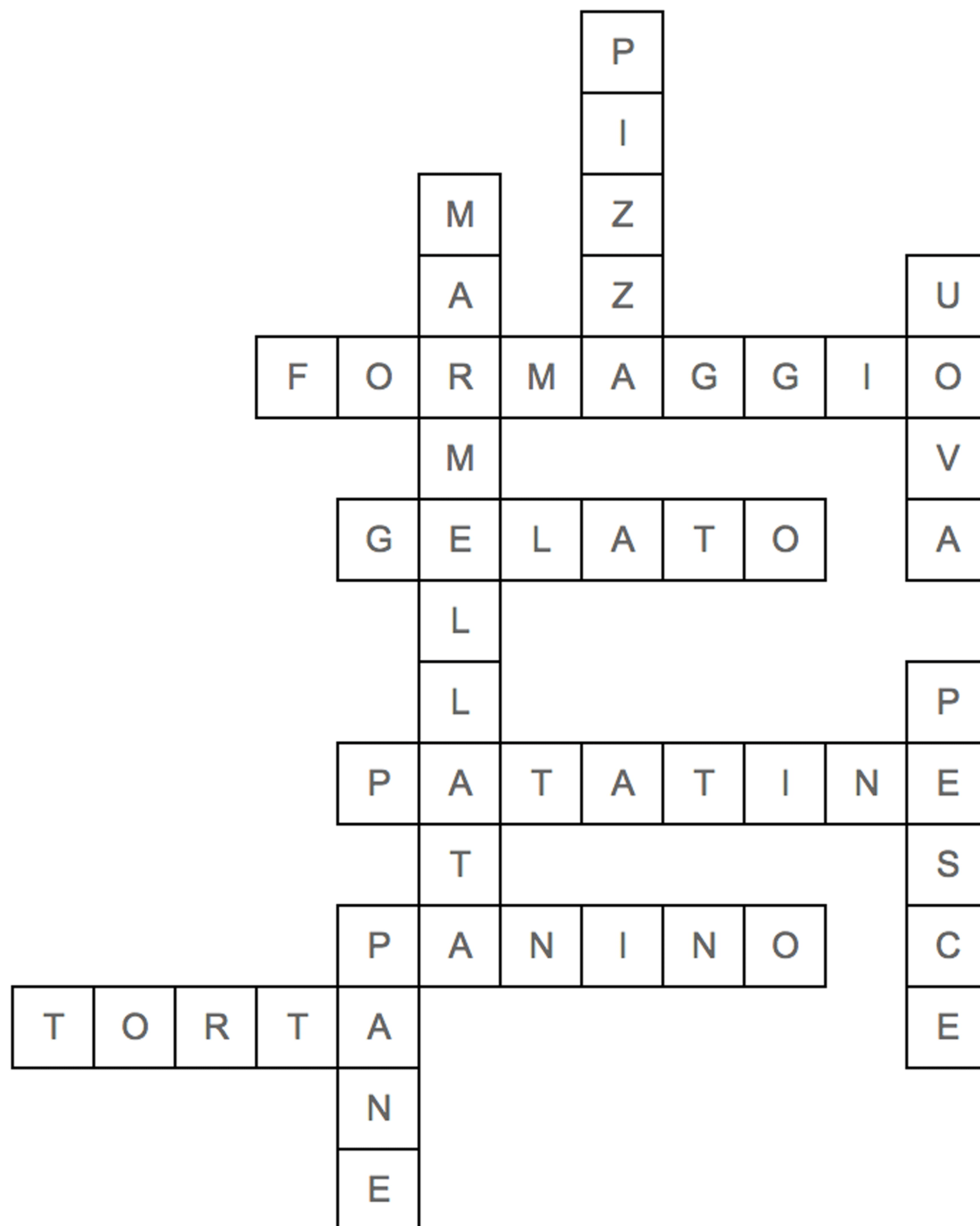

Orizzontali →

Verticali ↓

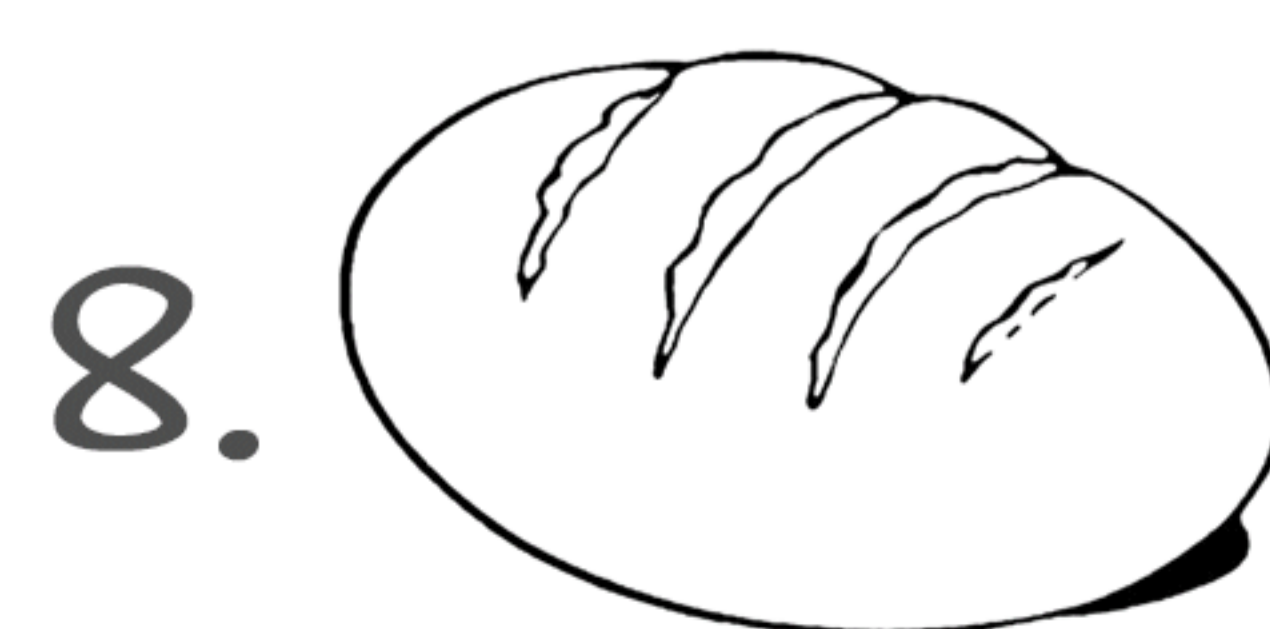
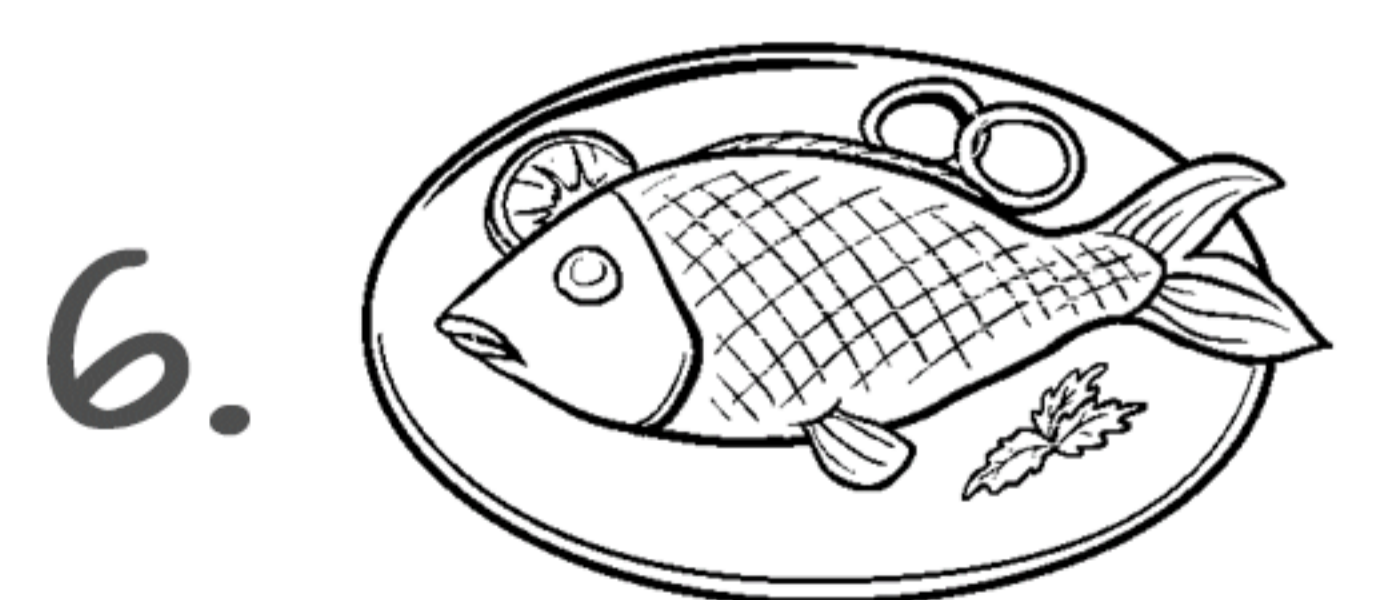
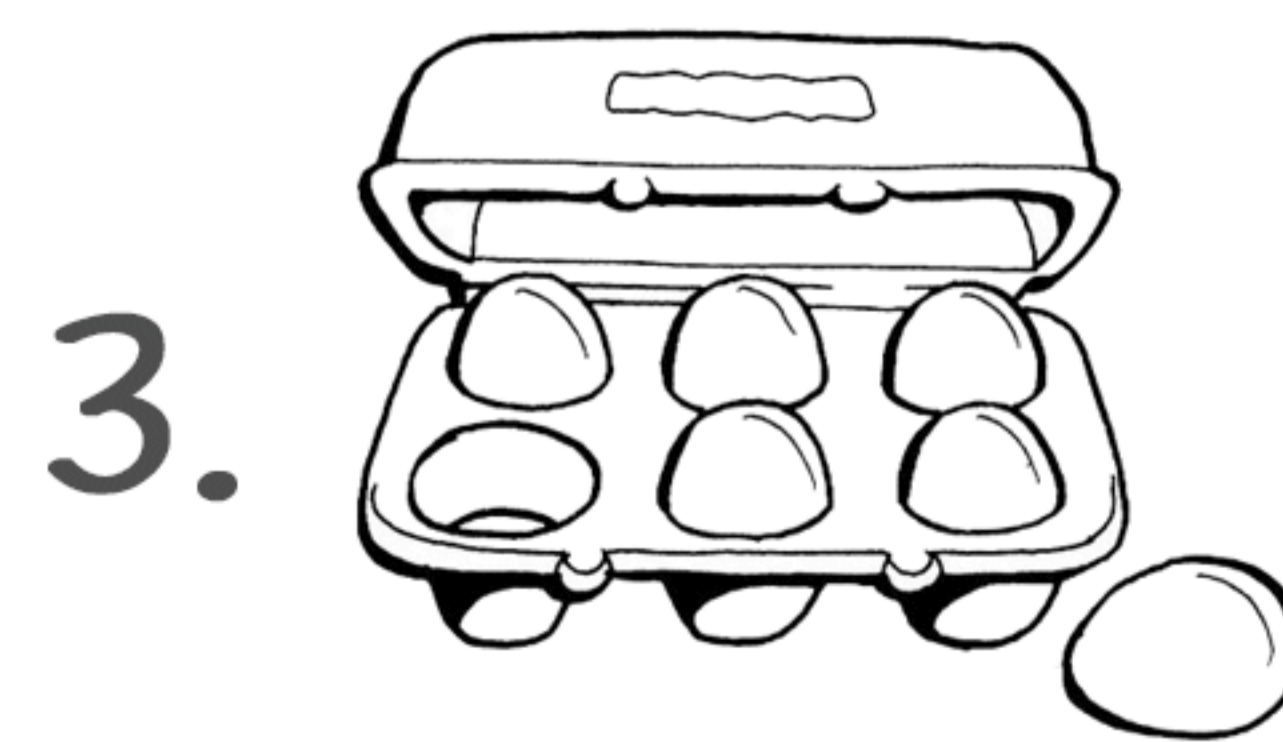
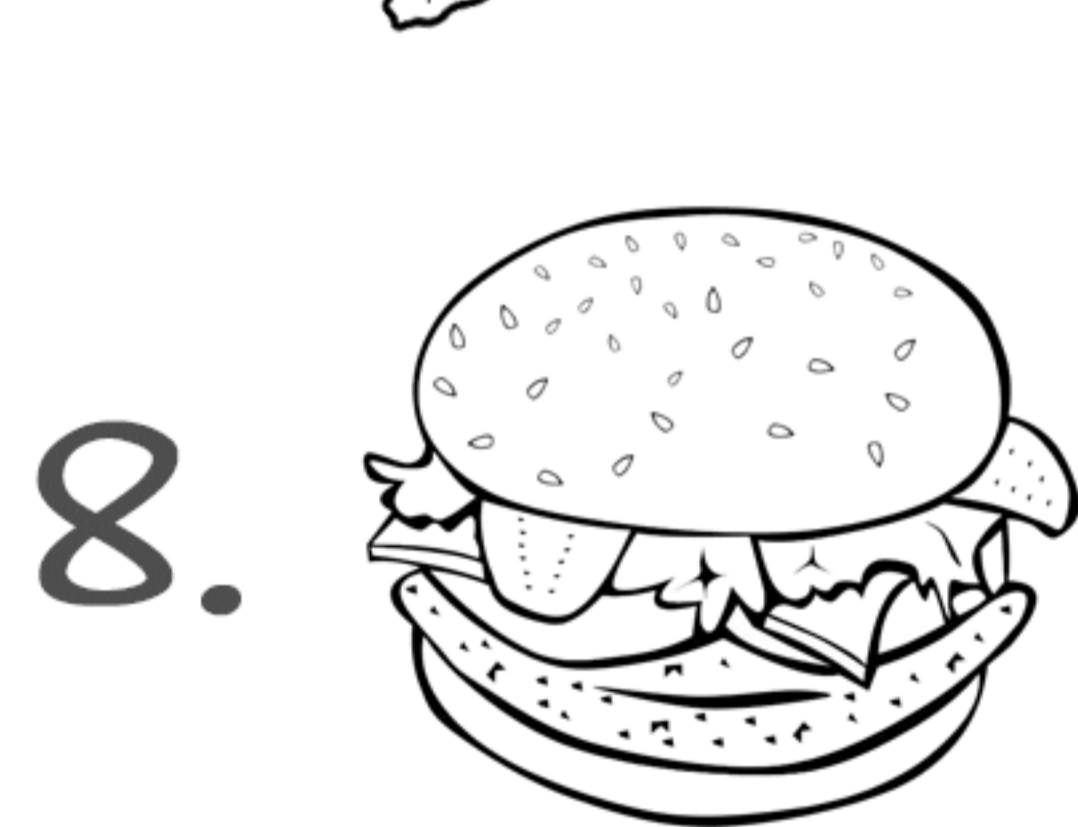
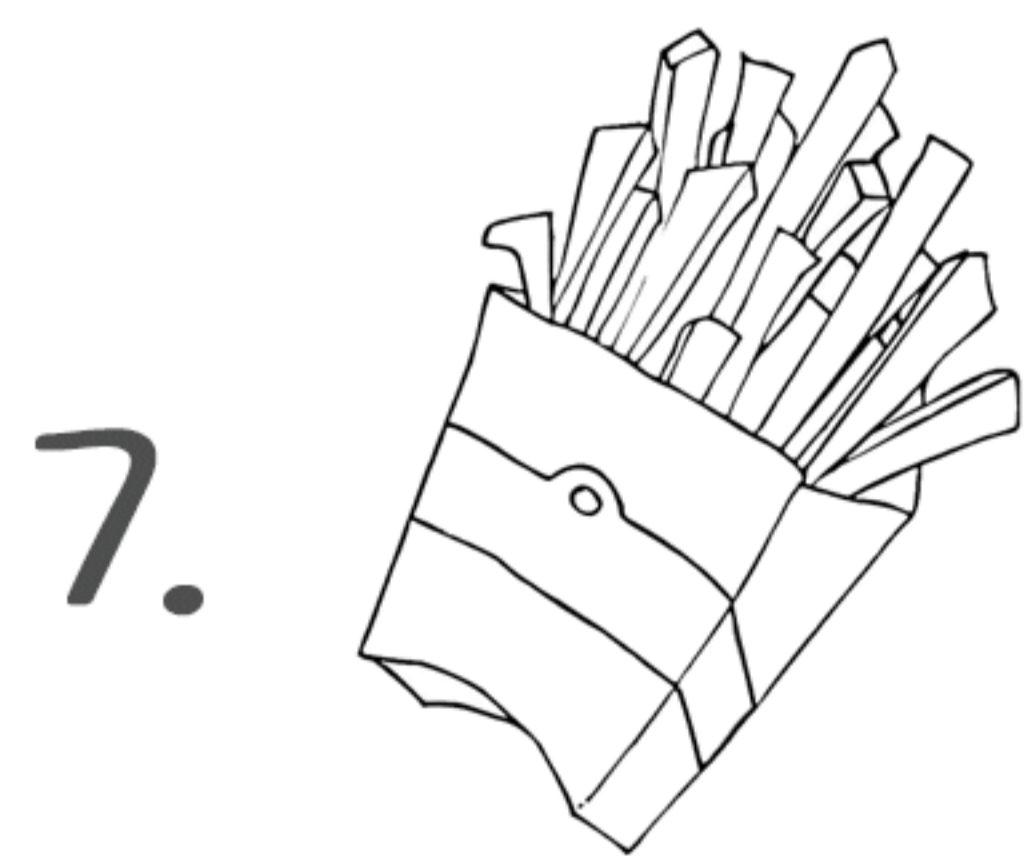
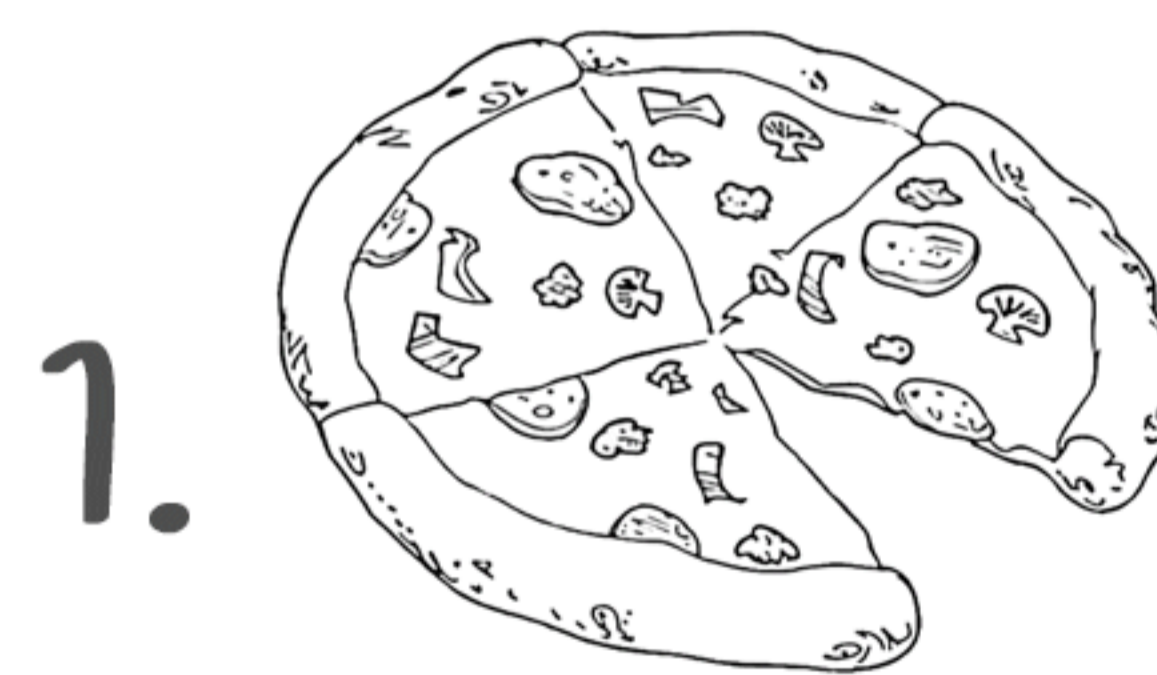
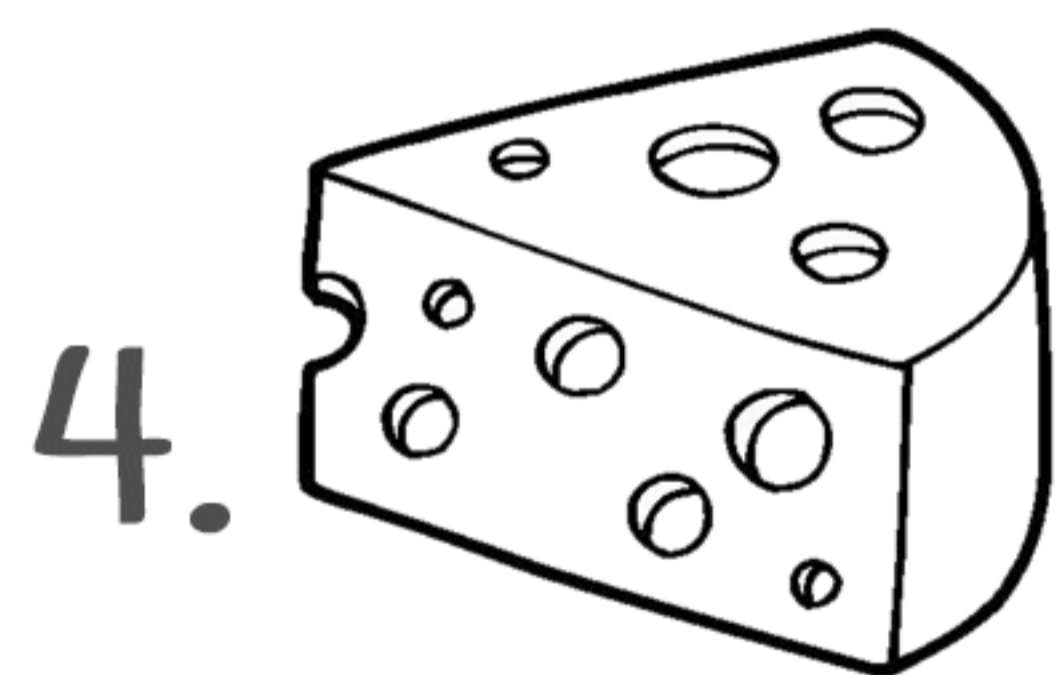

Cruciverba

Colori

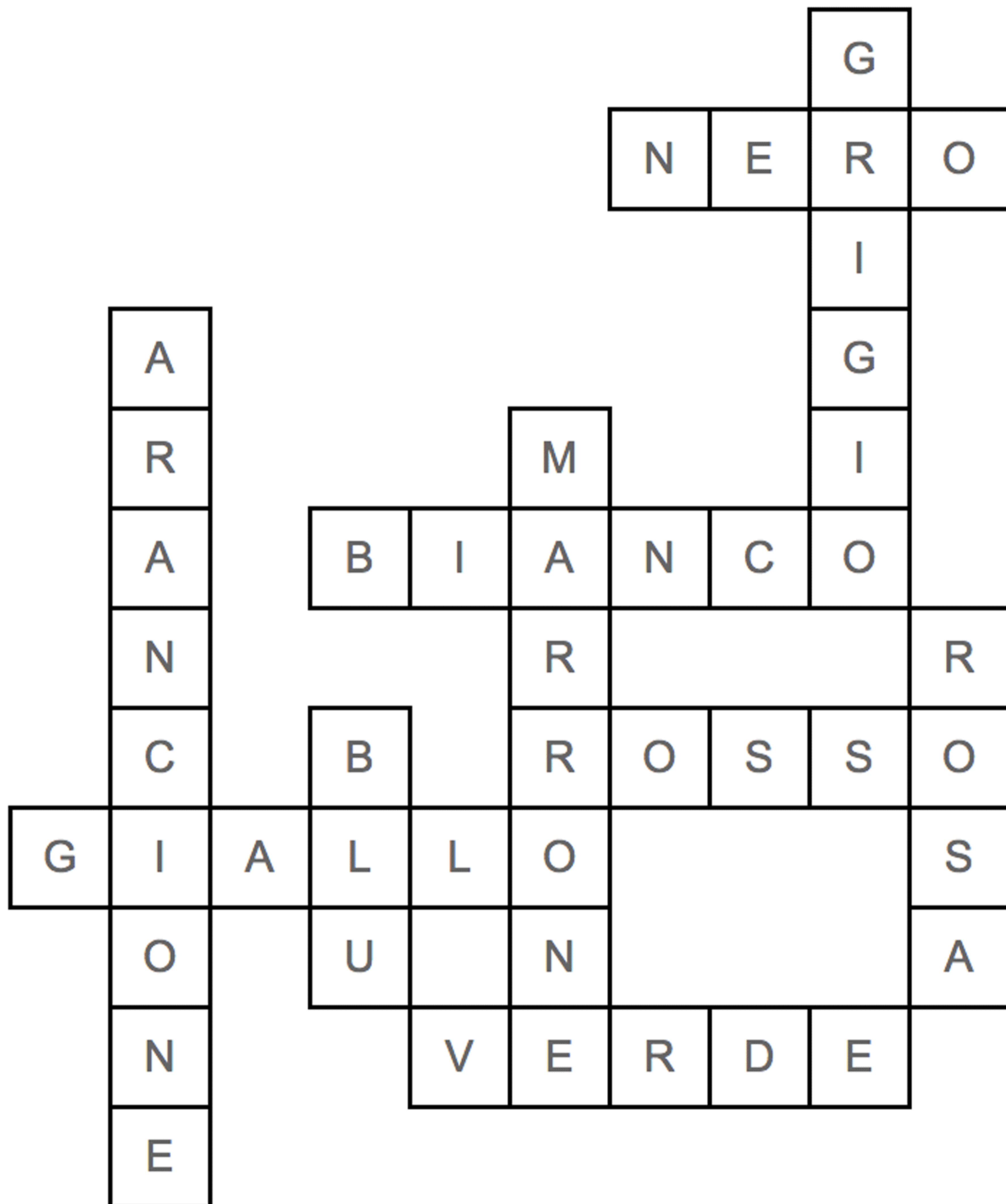

Orizzontali →

Verticali ↓

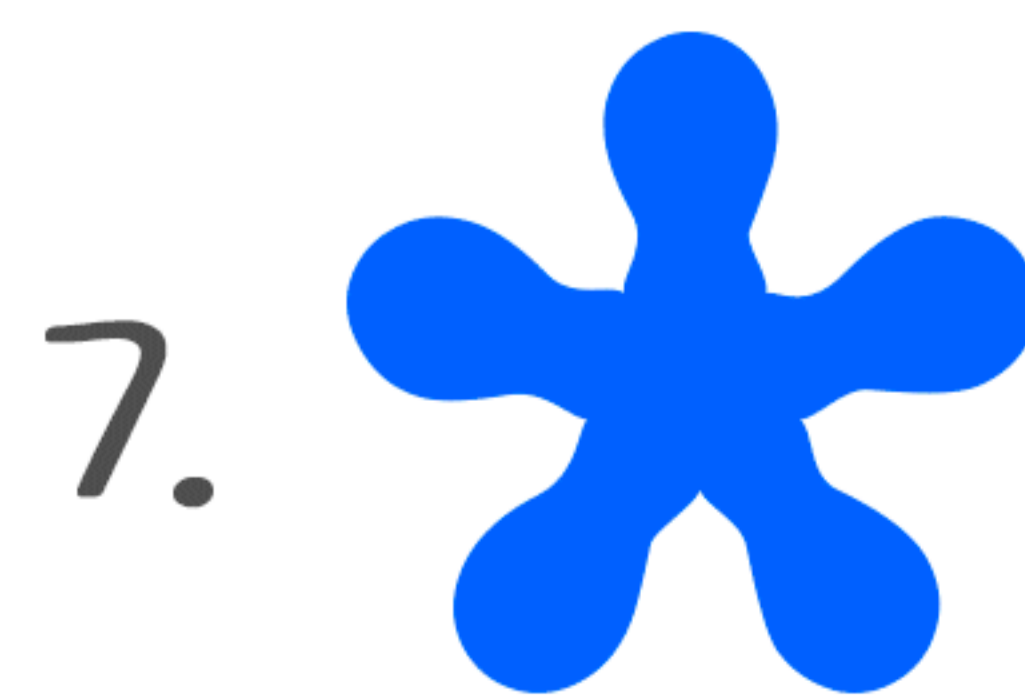
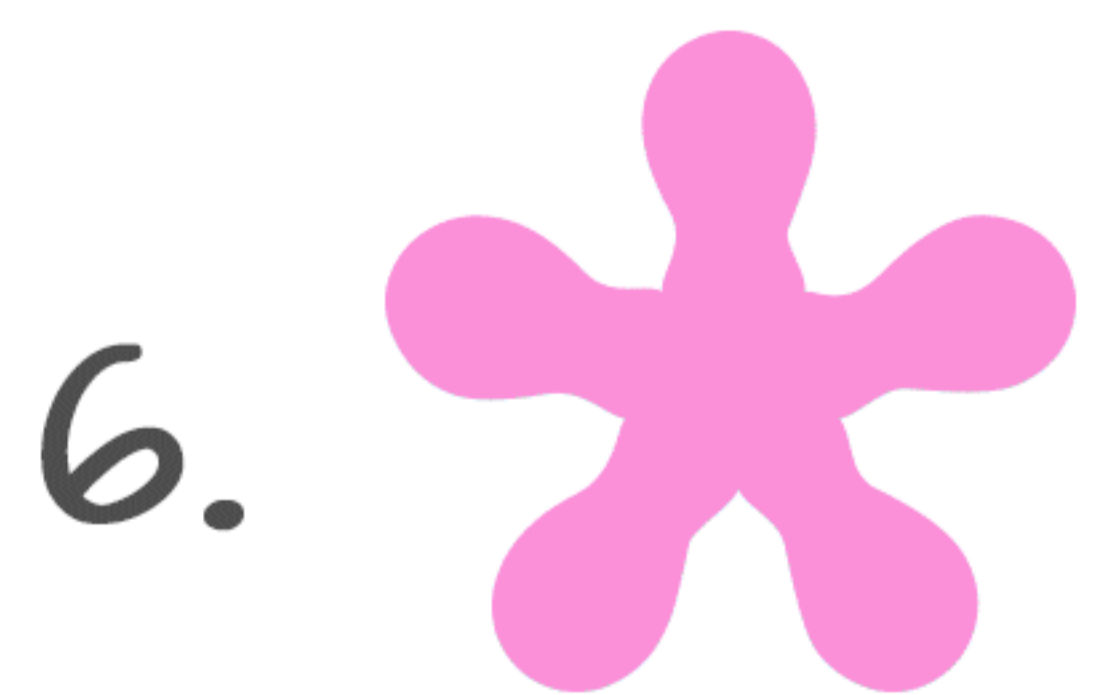
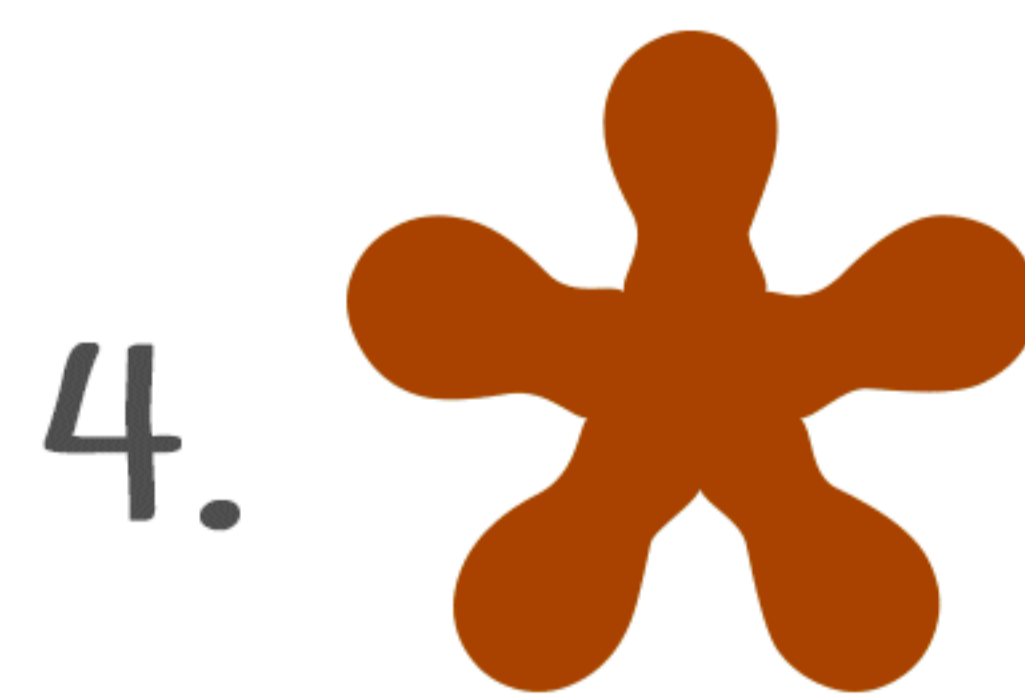
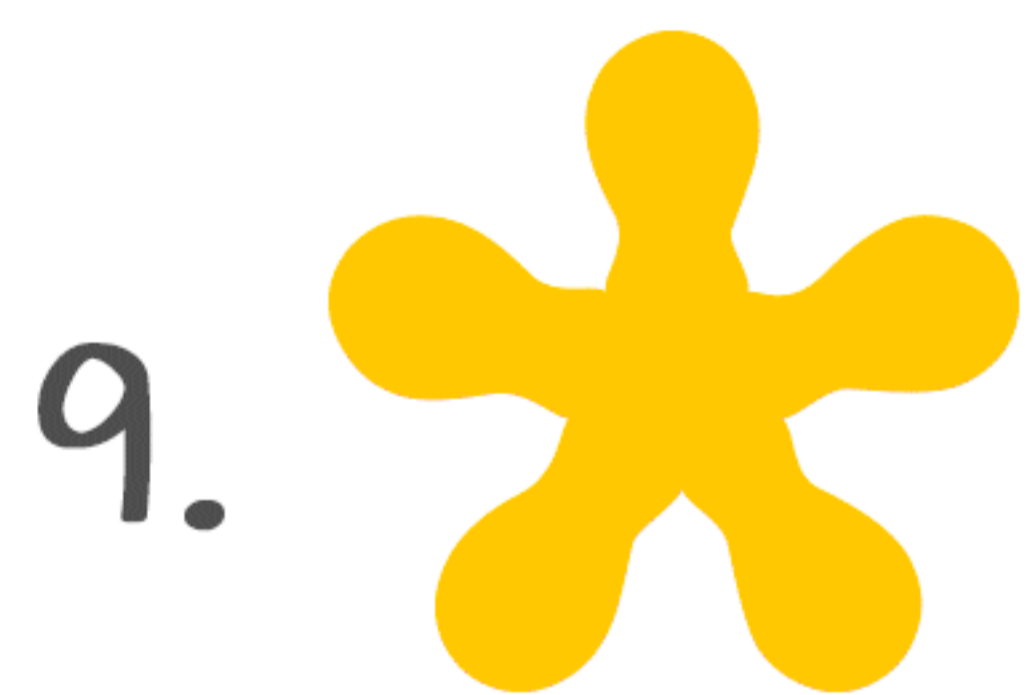
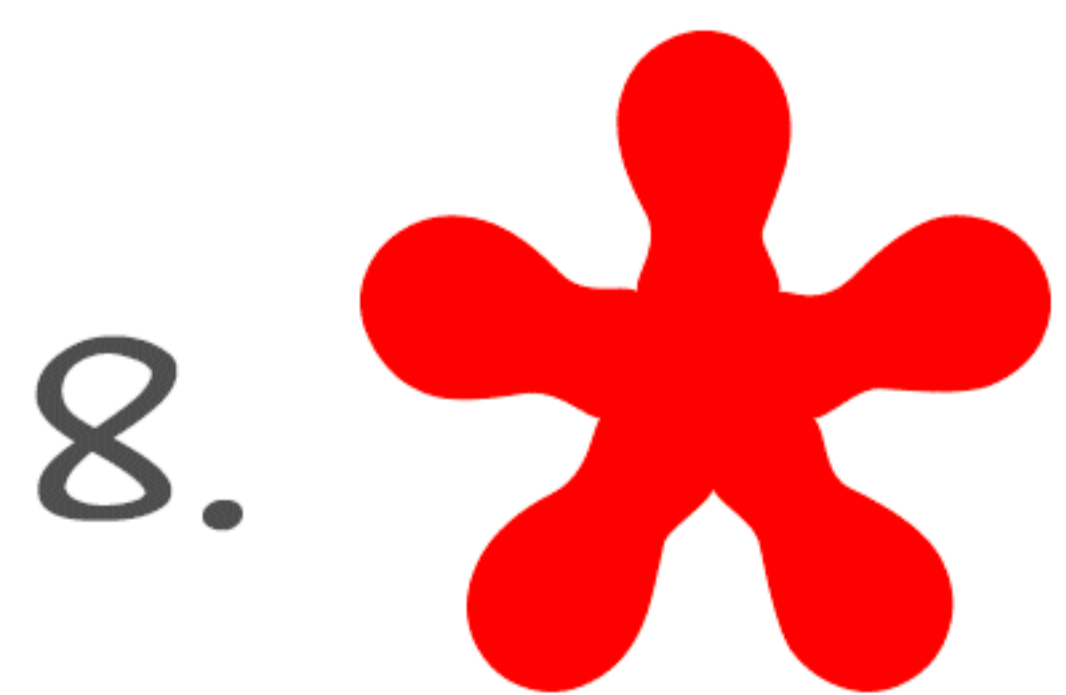
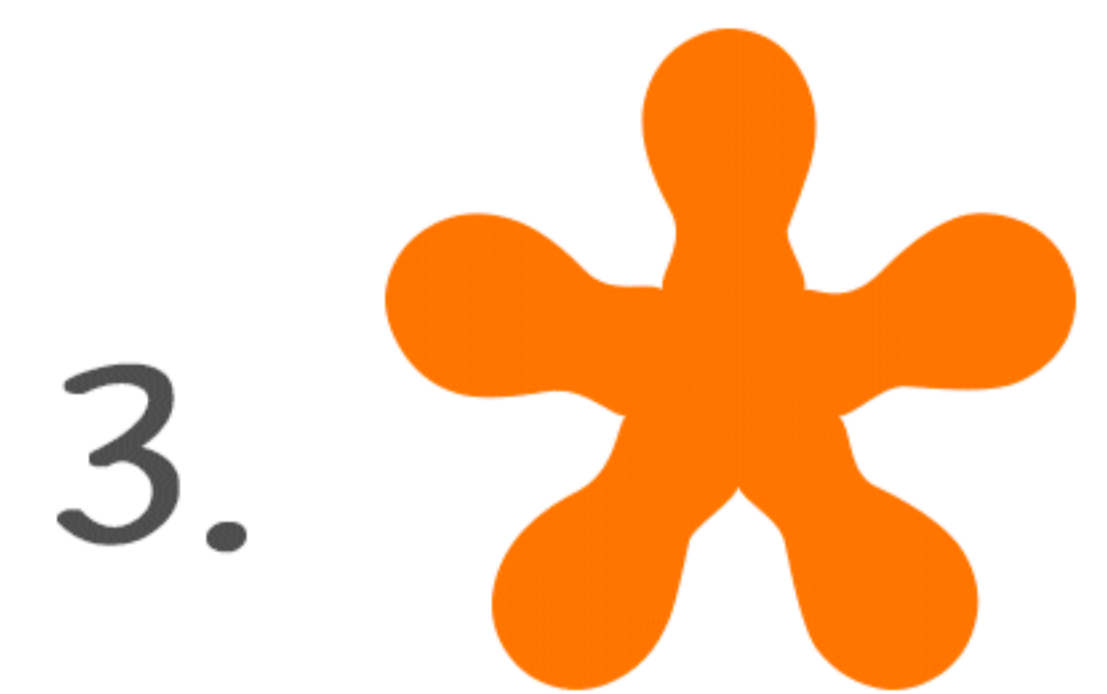
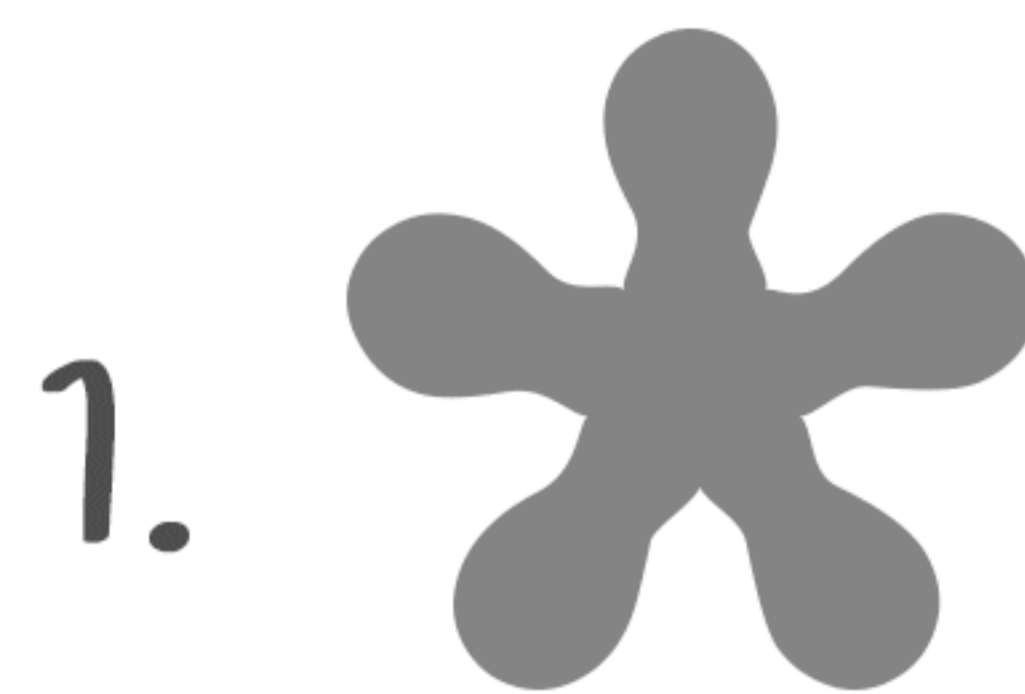
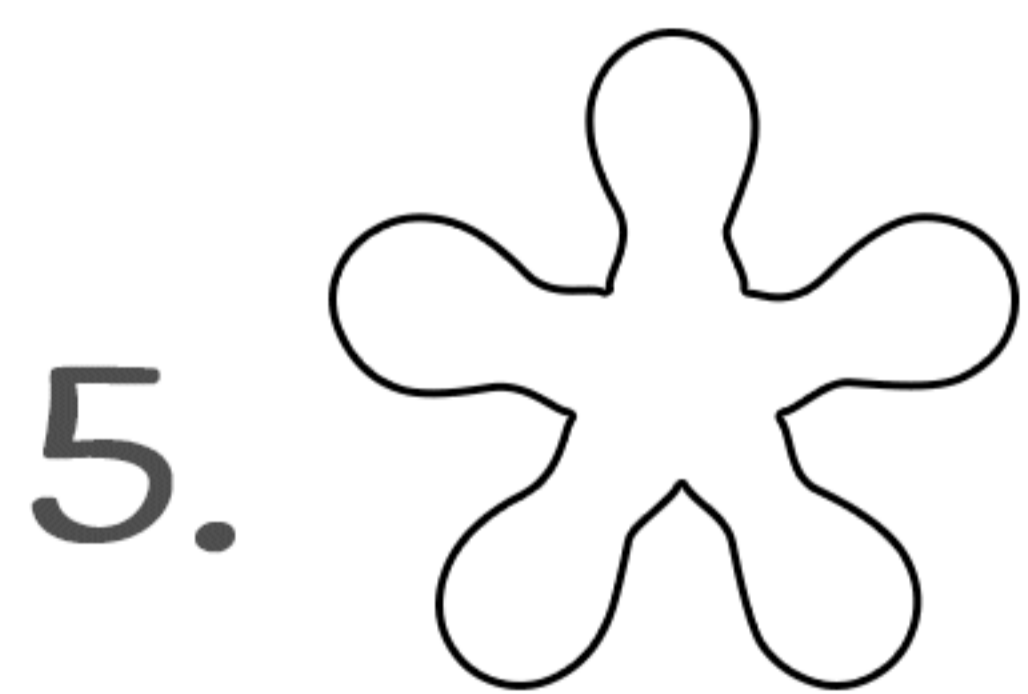
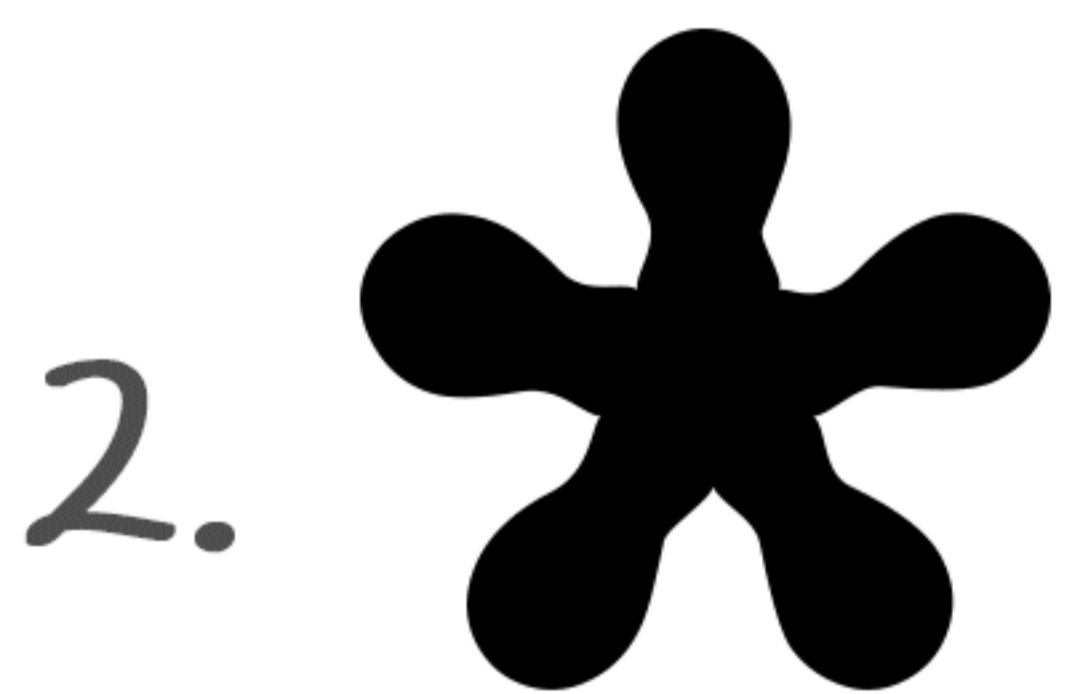

Cruciverba

Cucina

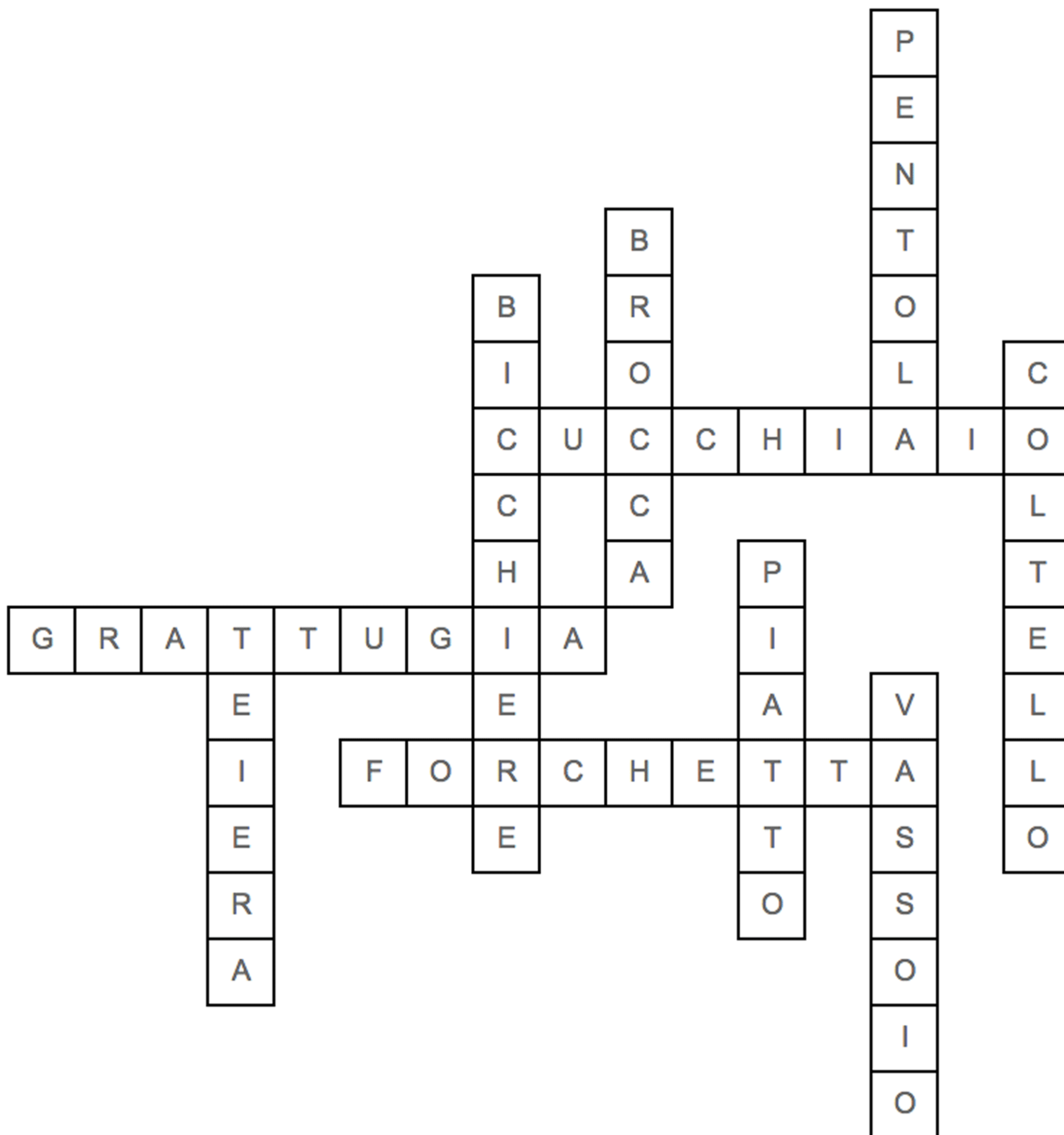

Orizzontali →

Verticali ↓

5.



7.

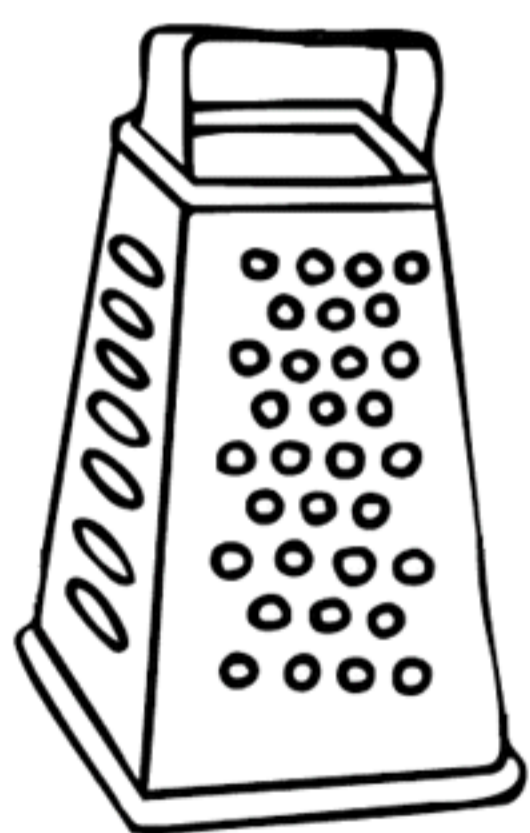

10.



1.

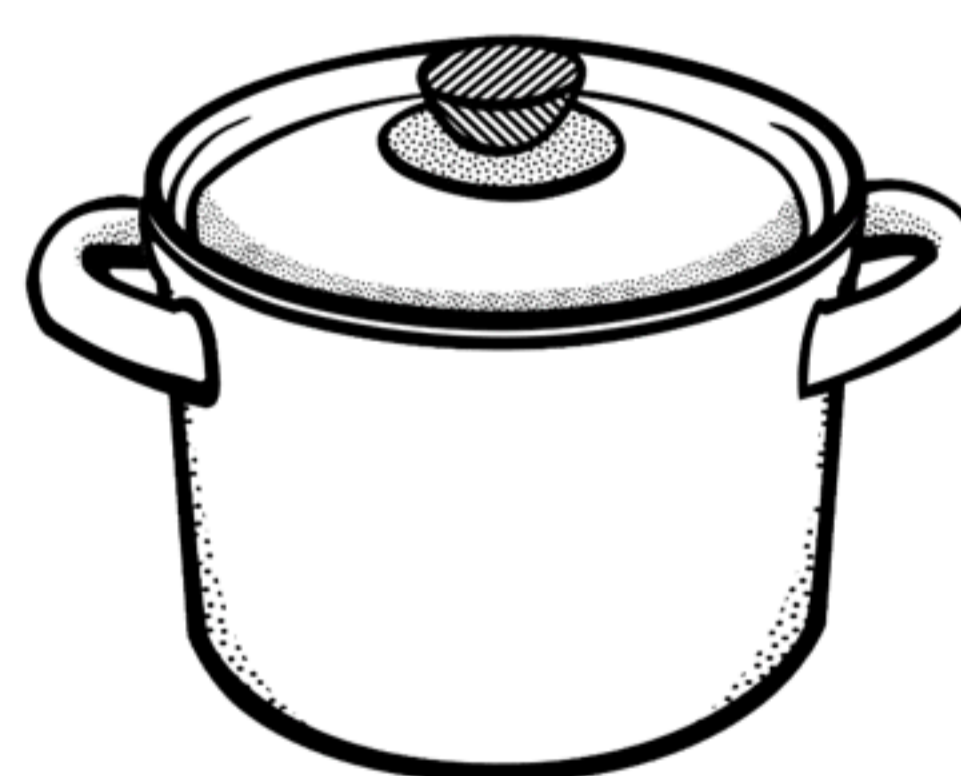

2.



3.



4.

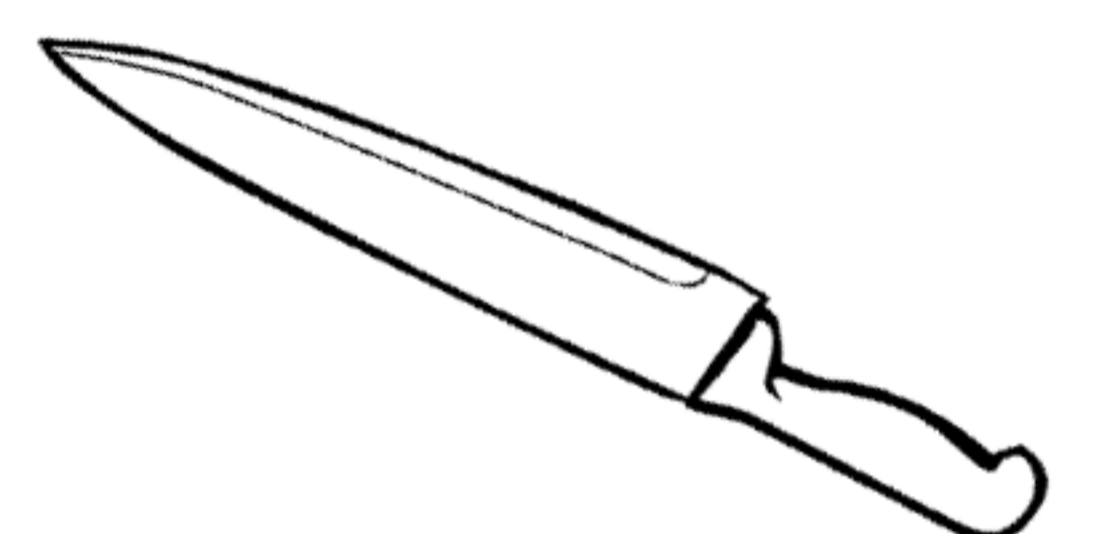

6.

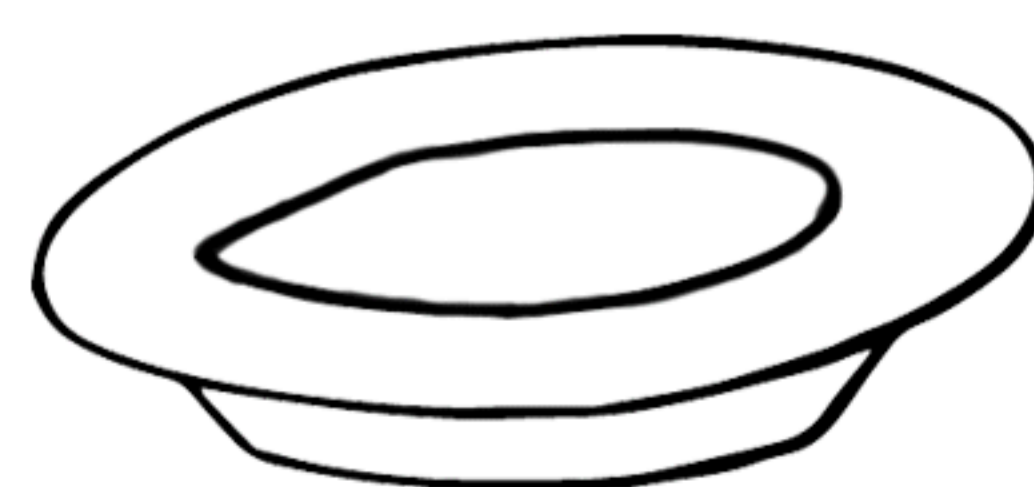

8.



9.

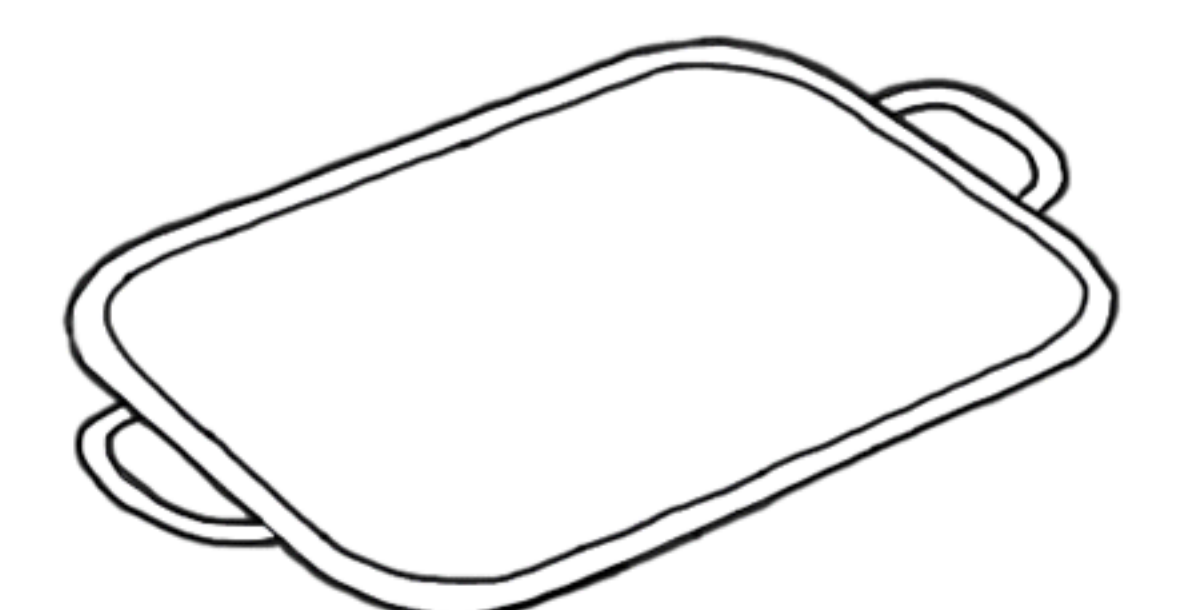

Cruciverba

Emozioni

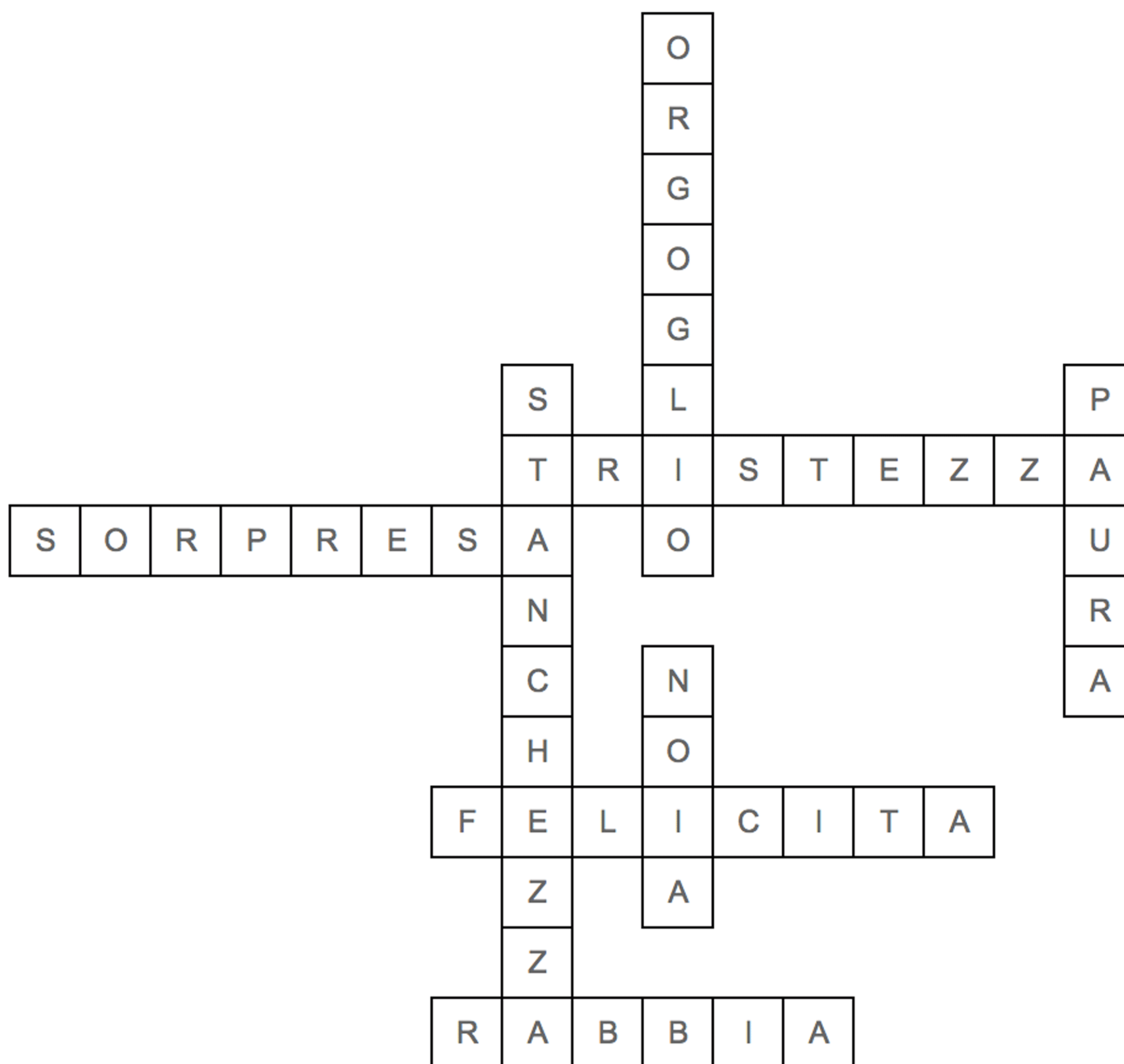

Orizzontali →

Verticali ↓

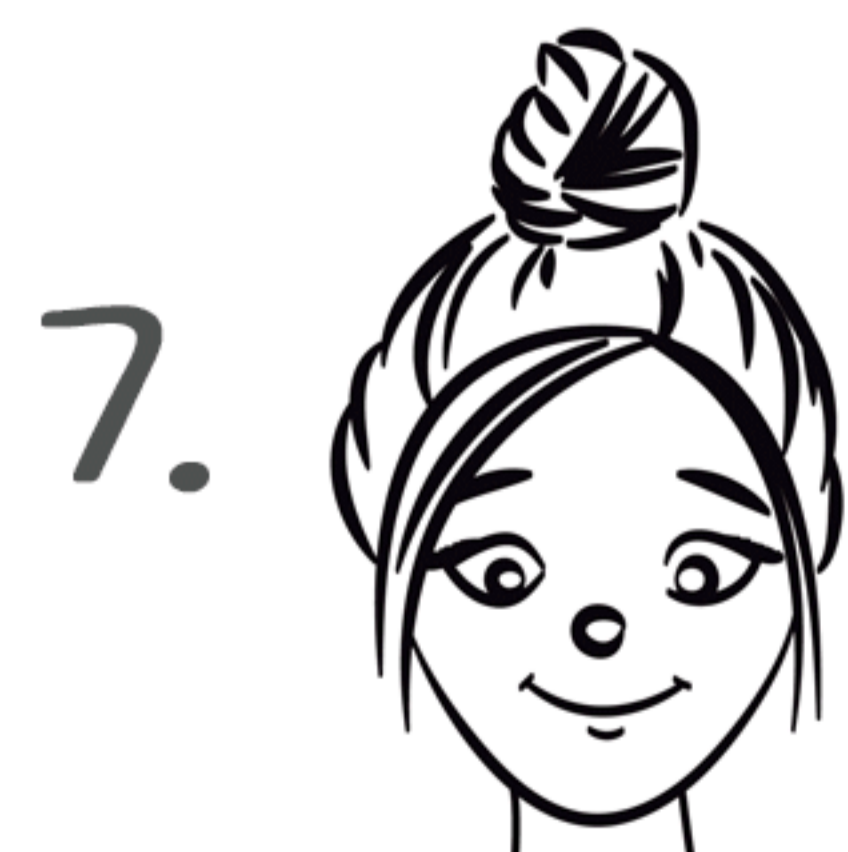

Cruciverba

Frutta

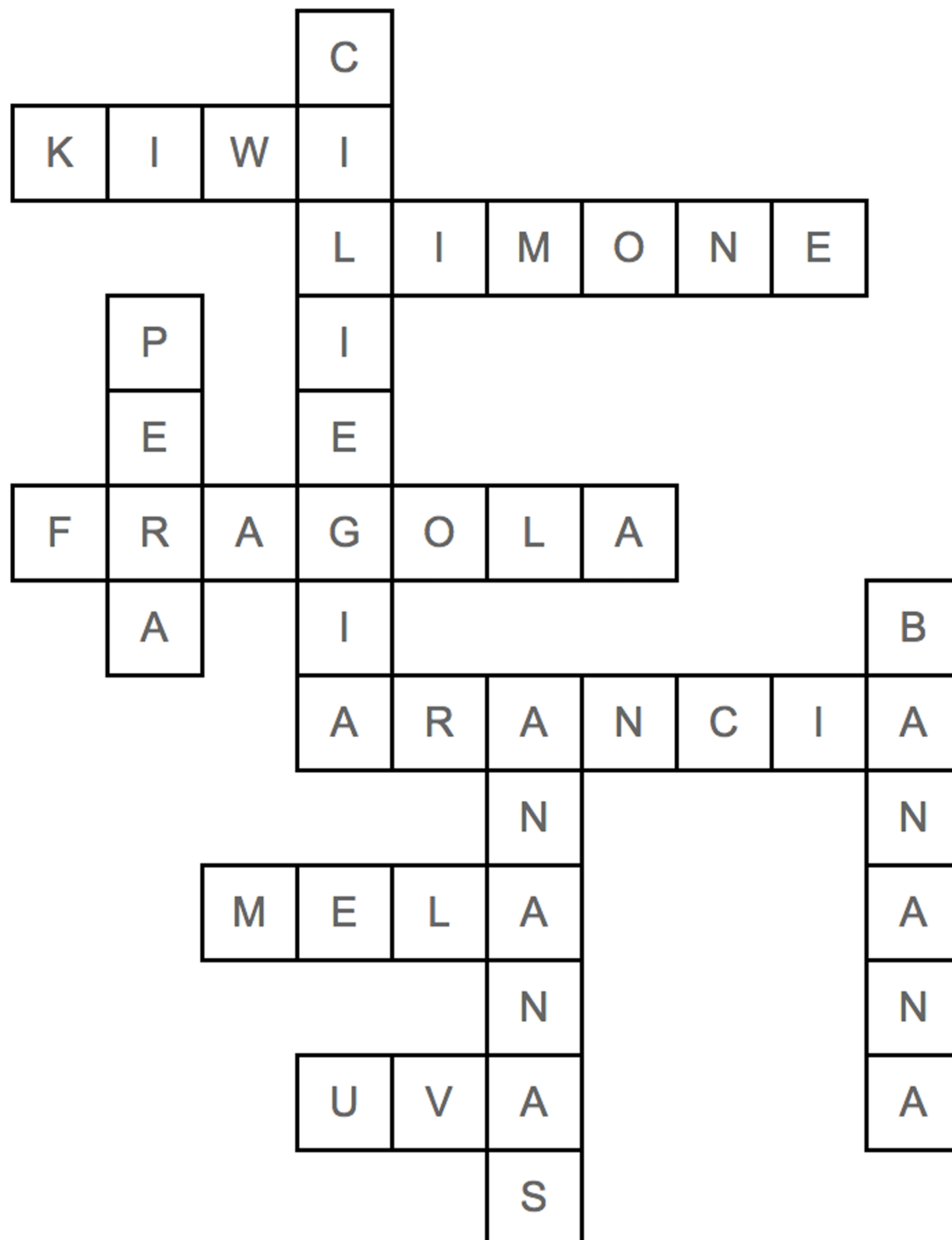

Orizzontali →

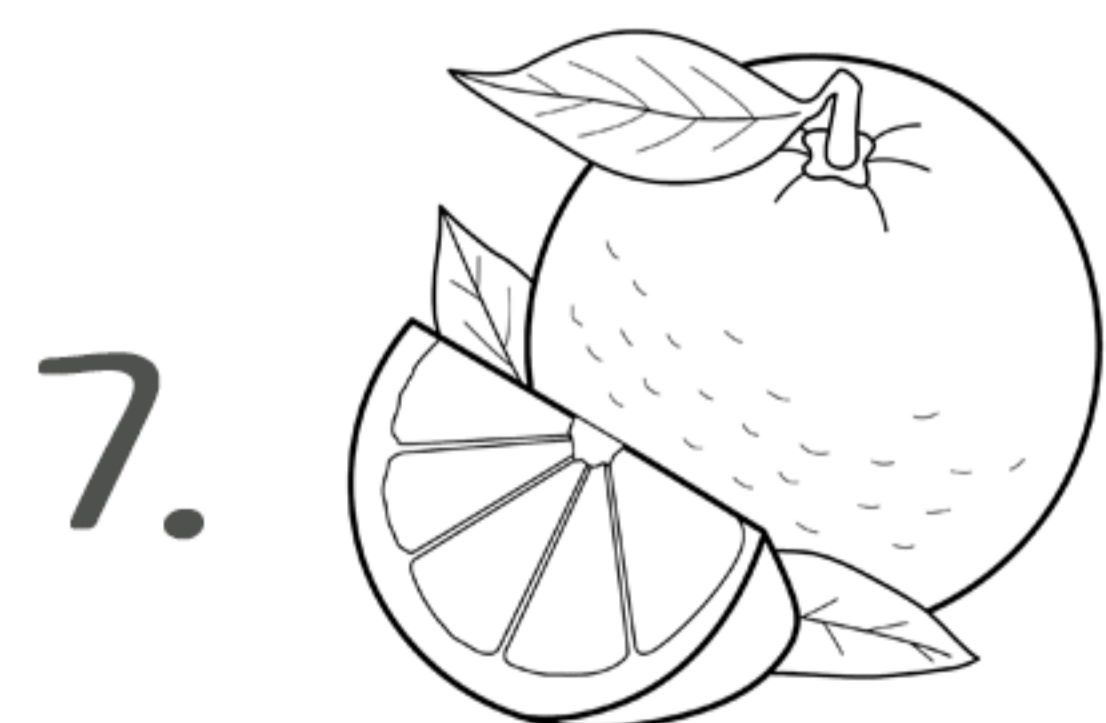
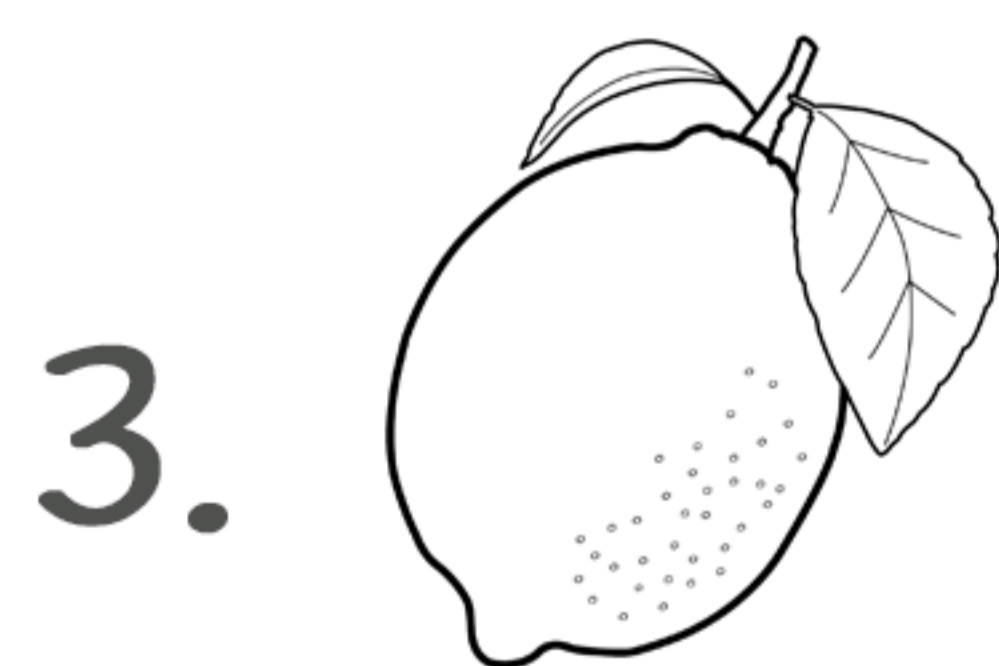
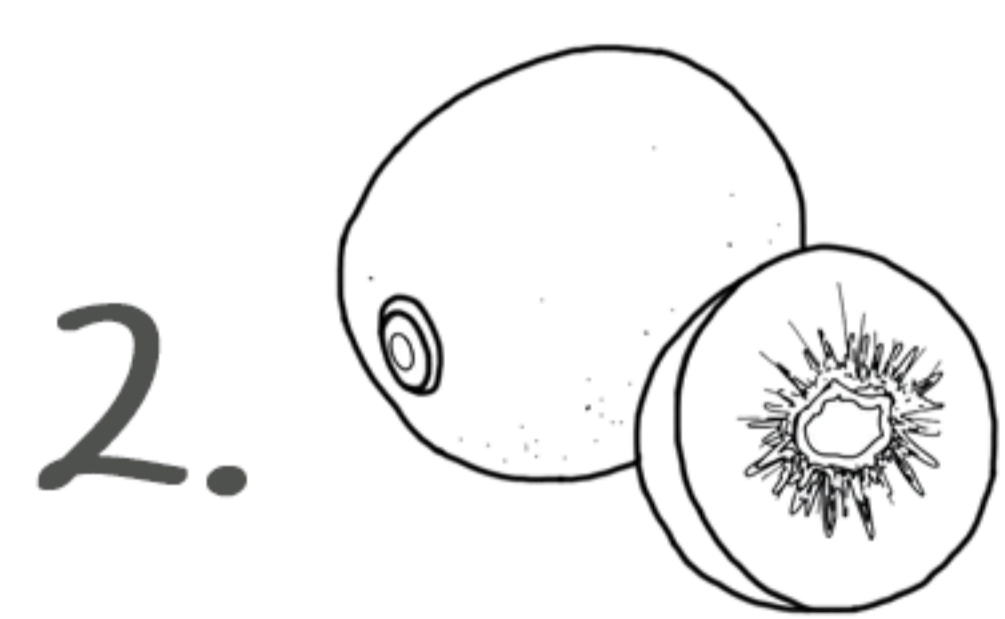

Verticali ↓

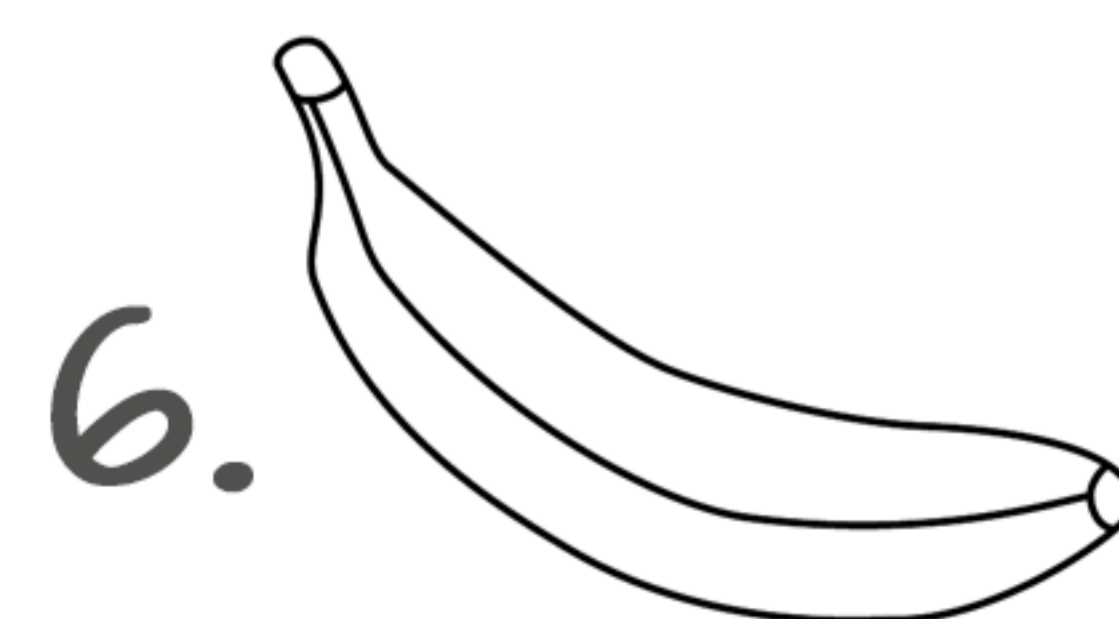

Cruciverba

Insetti

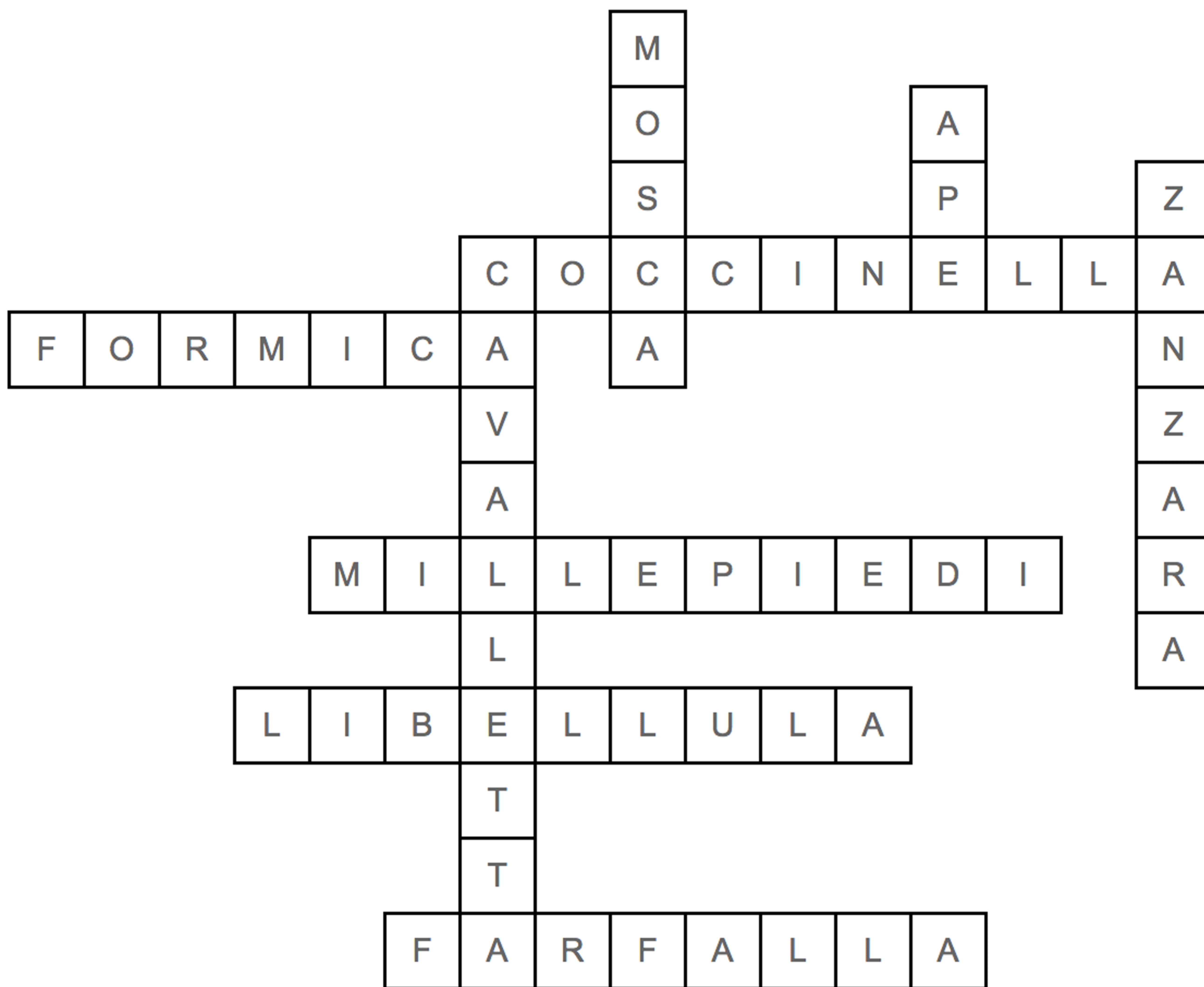

Orizzontali →

Verticali ↓

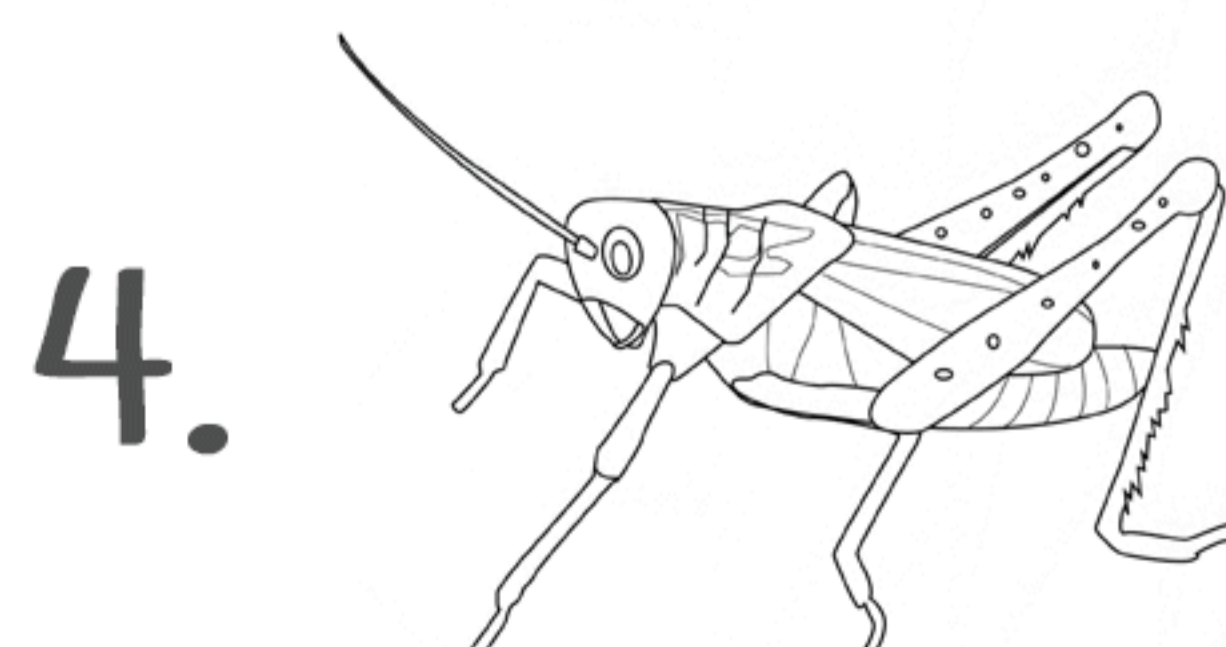
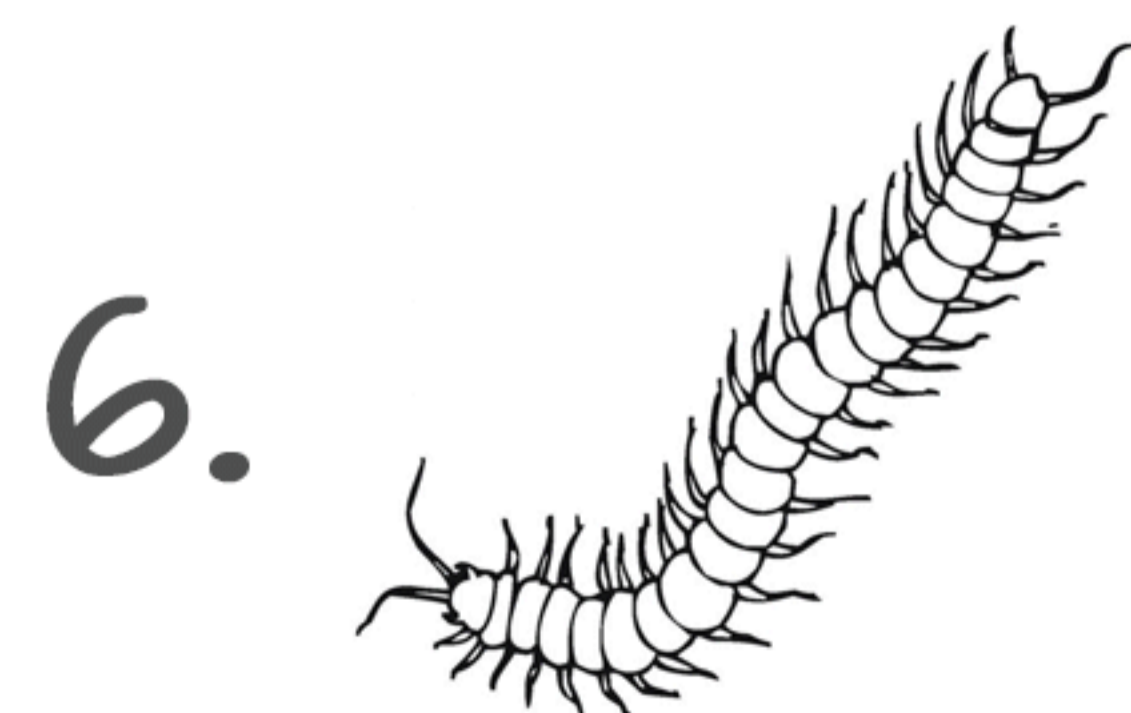
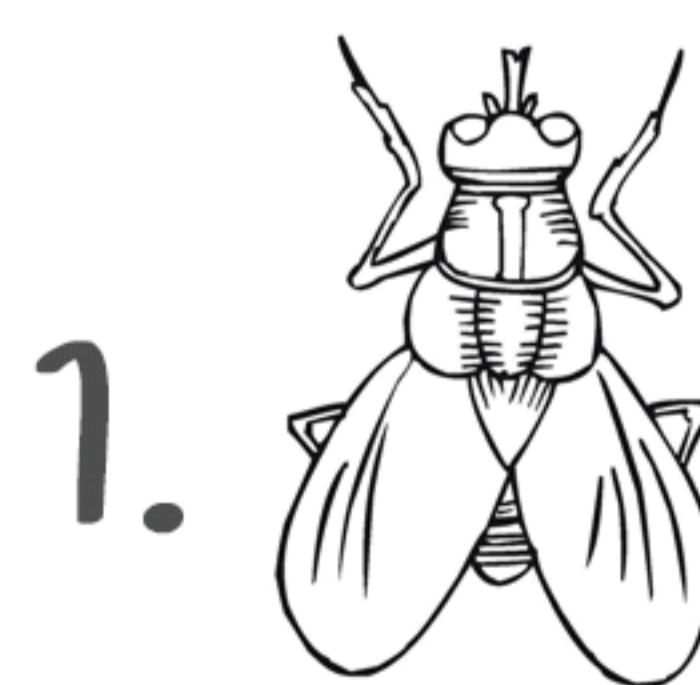
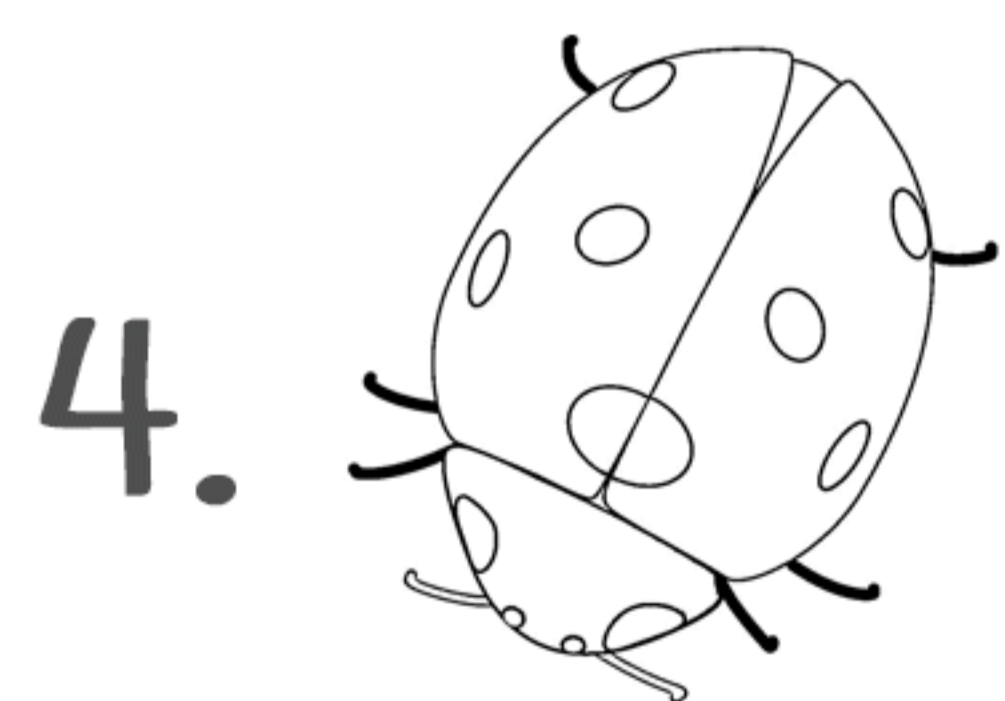

Cruciverba

Parti del corpo

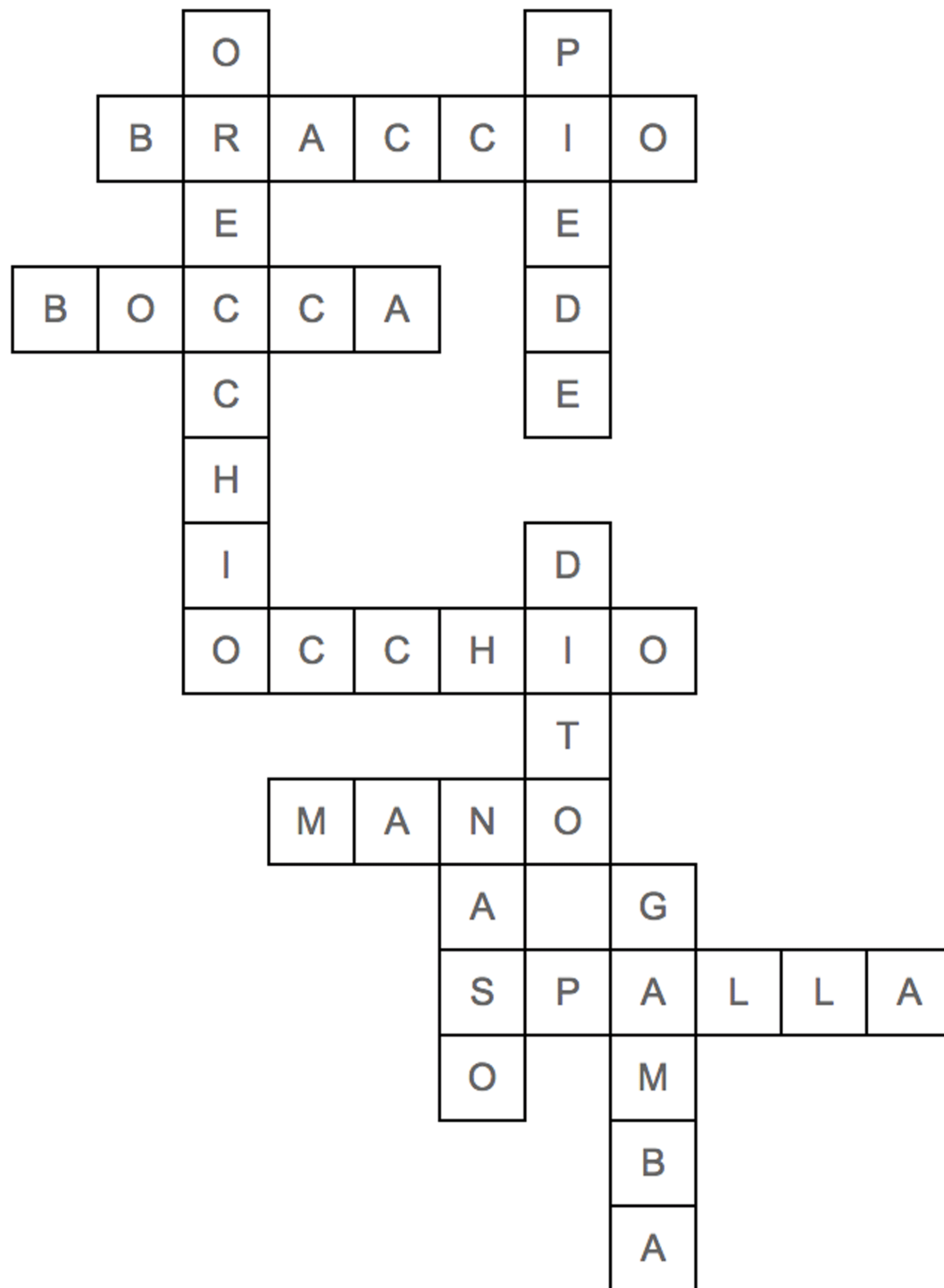

Orizzontali →

Verticali ↓



Cruciverba

Veicoli

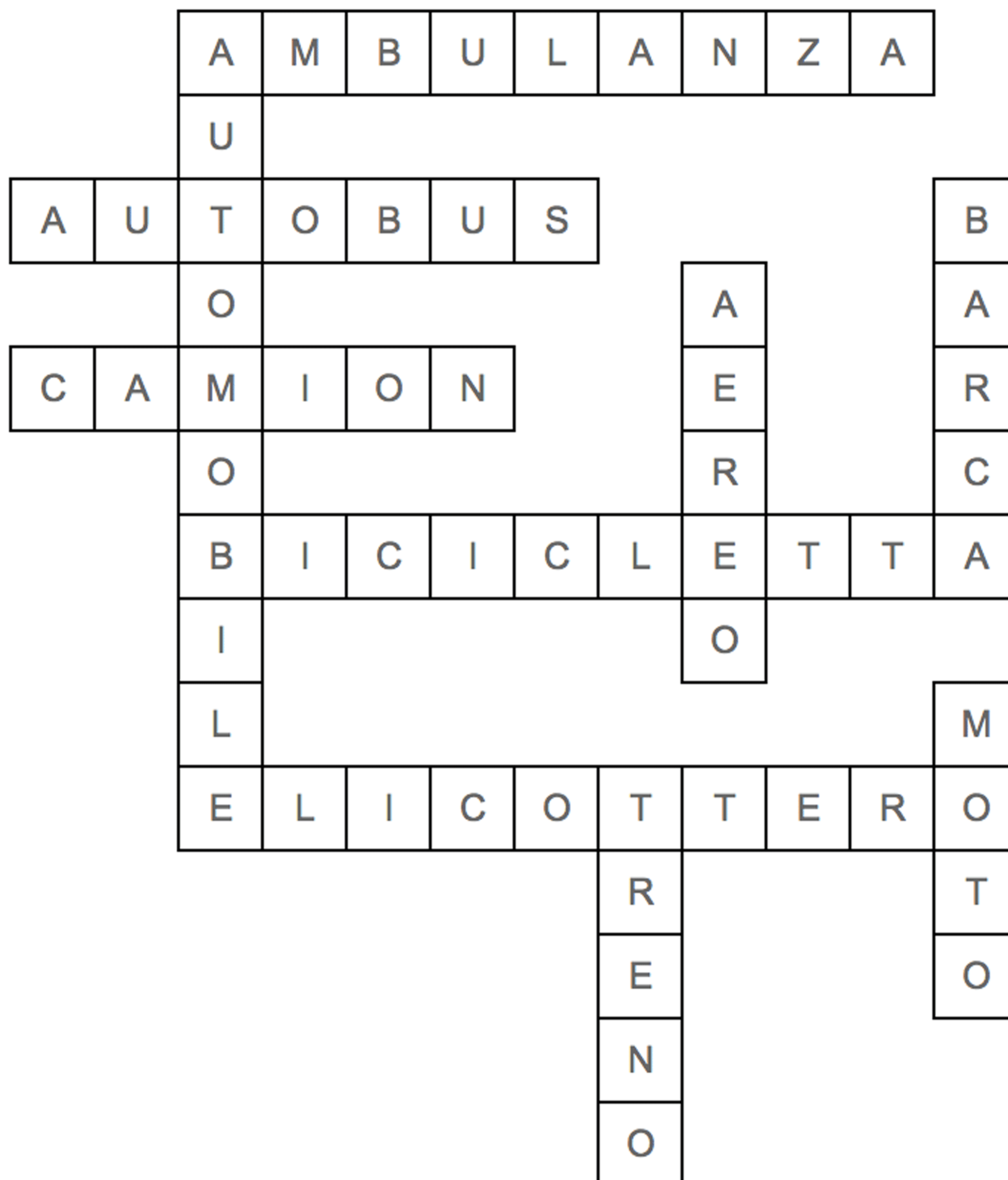

Orizzontali →

Verticali ↓

1.

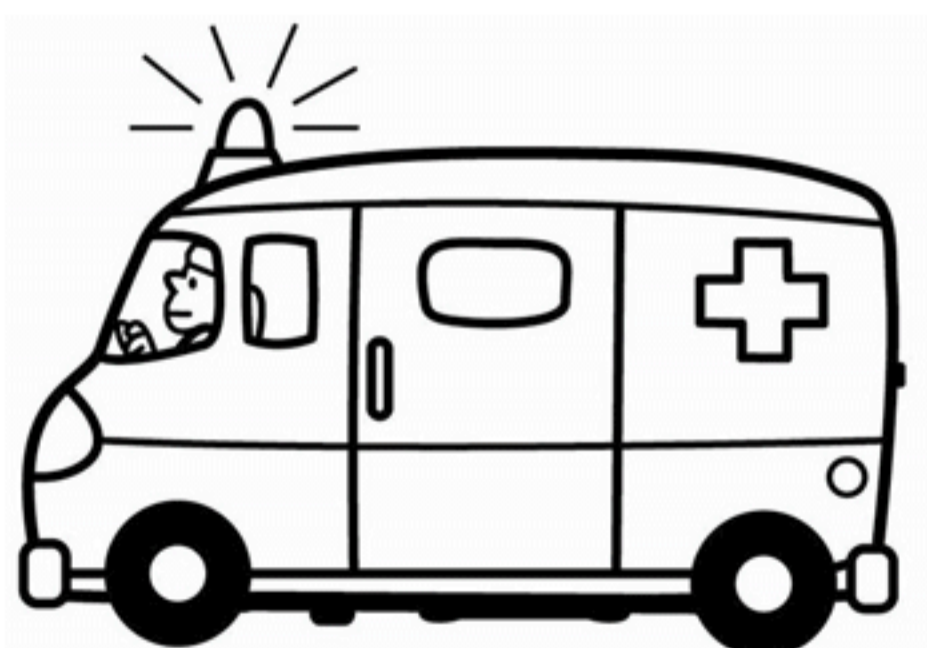

2.



1.

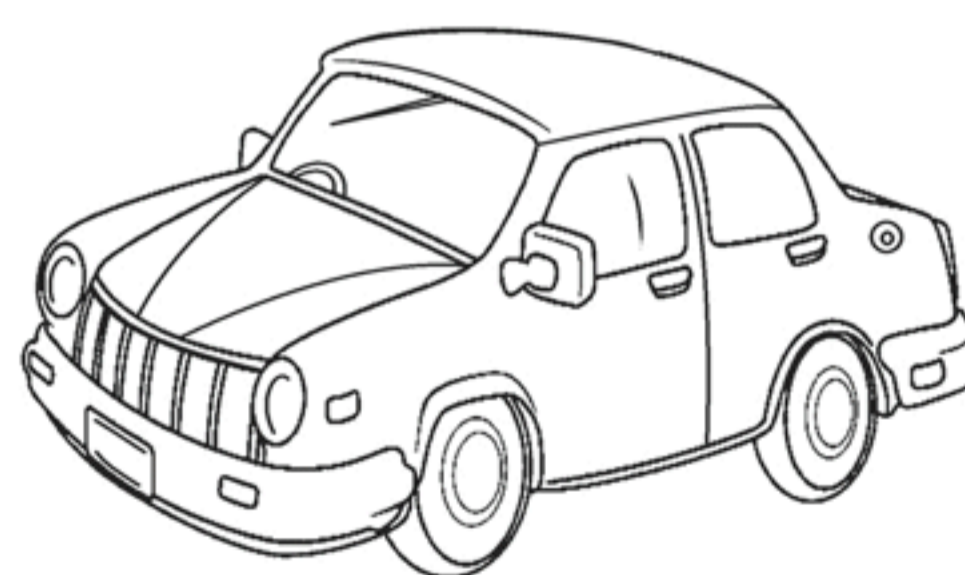

3.

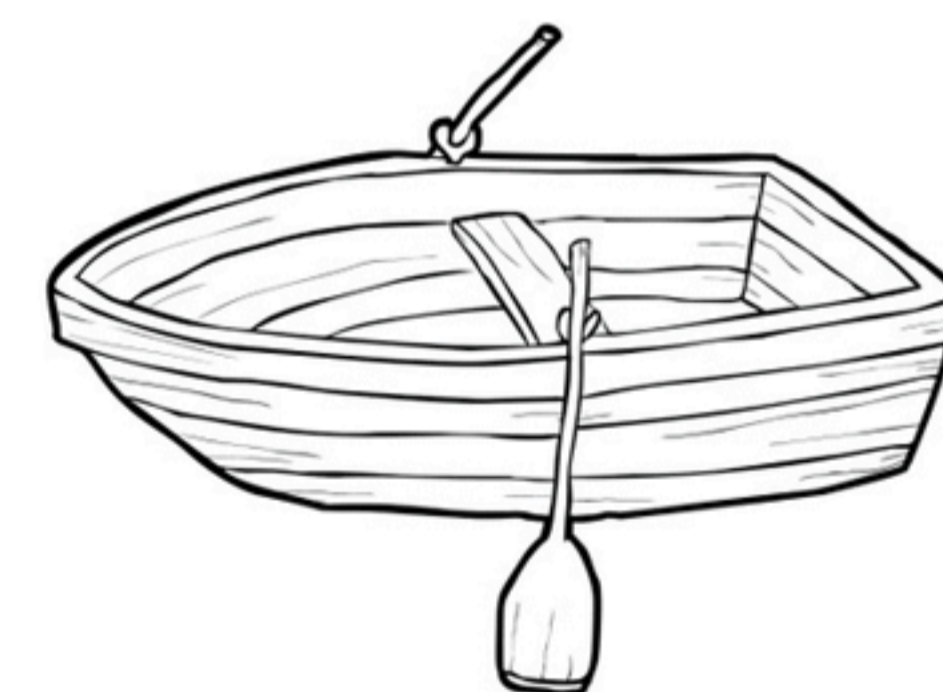

5.

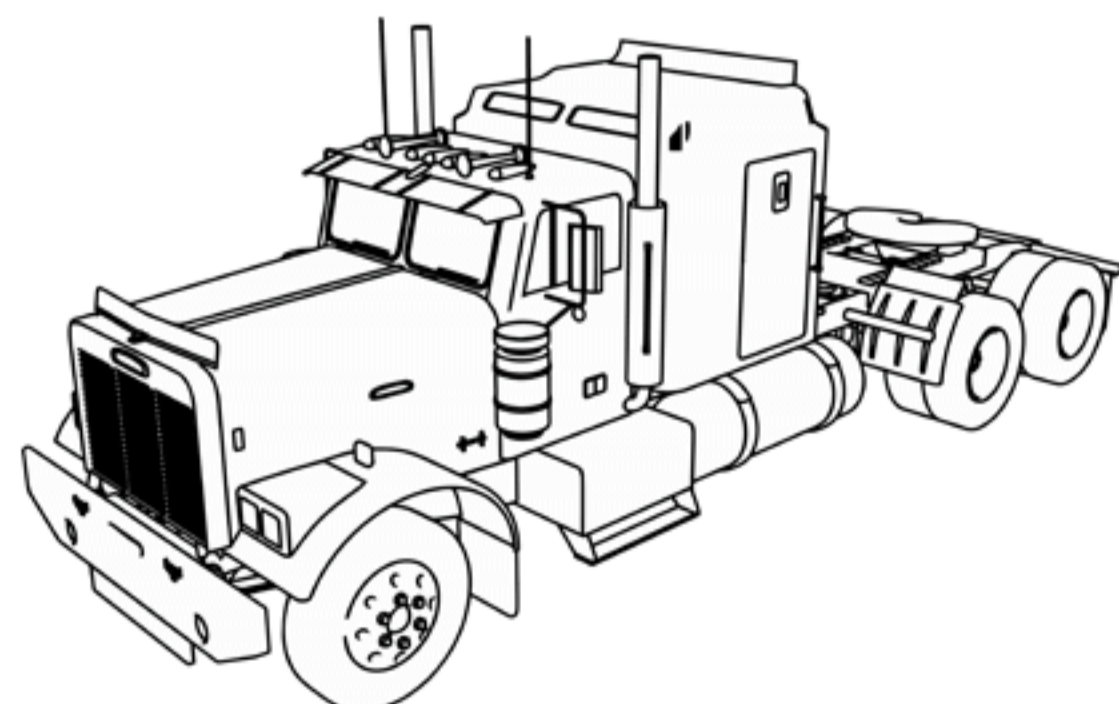

6.

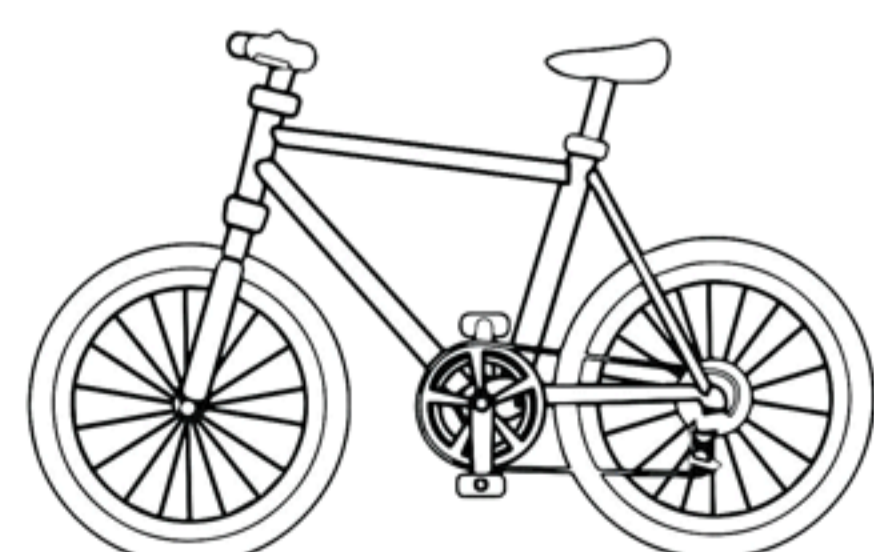

4.



7.

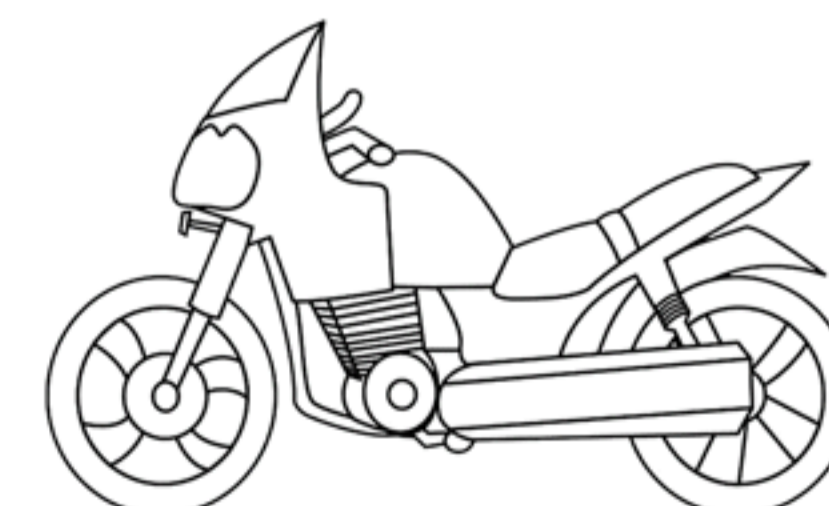

8.



9.

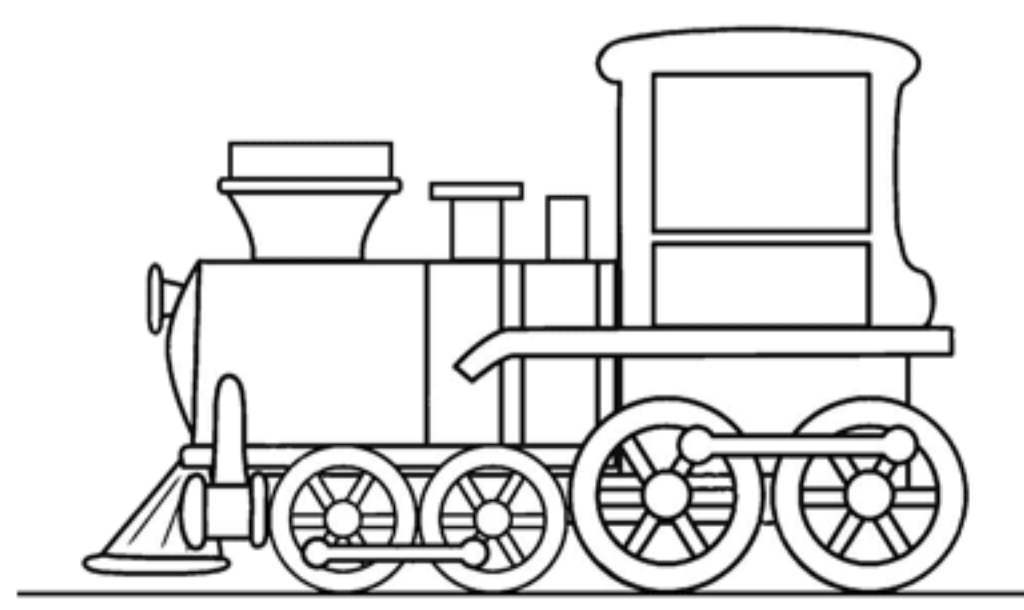

Cruciverba

Verdure

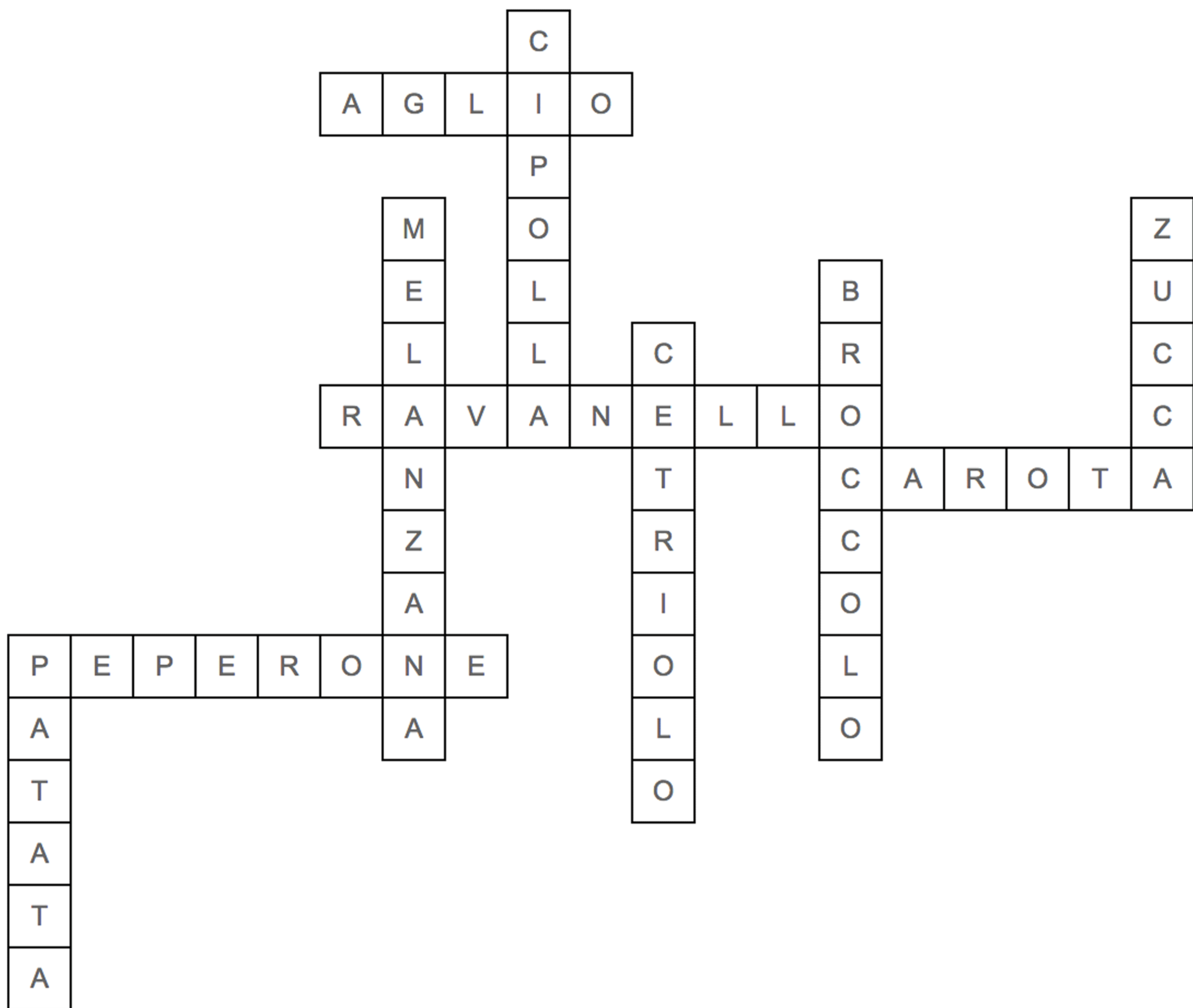

Orizzontali →

Verticali ↓

